

3-640429-6 ✓ ACTIVE



## MTA 156

TE Internal #: 3-640429-6

Rectangular Power Connectors, Connector Assembly, Receptacle, Wire-to-Board, 6 Position, 3.96 mm [.156 in] Centerline, Wire & Cable, UL 94V-2, MTA 156

[View on TE.com >](#)

Connectors > Power Connectors > Rectangular Power > Rectangular Power Connectors

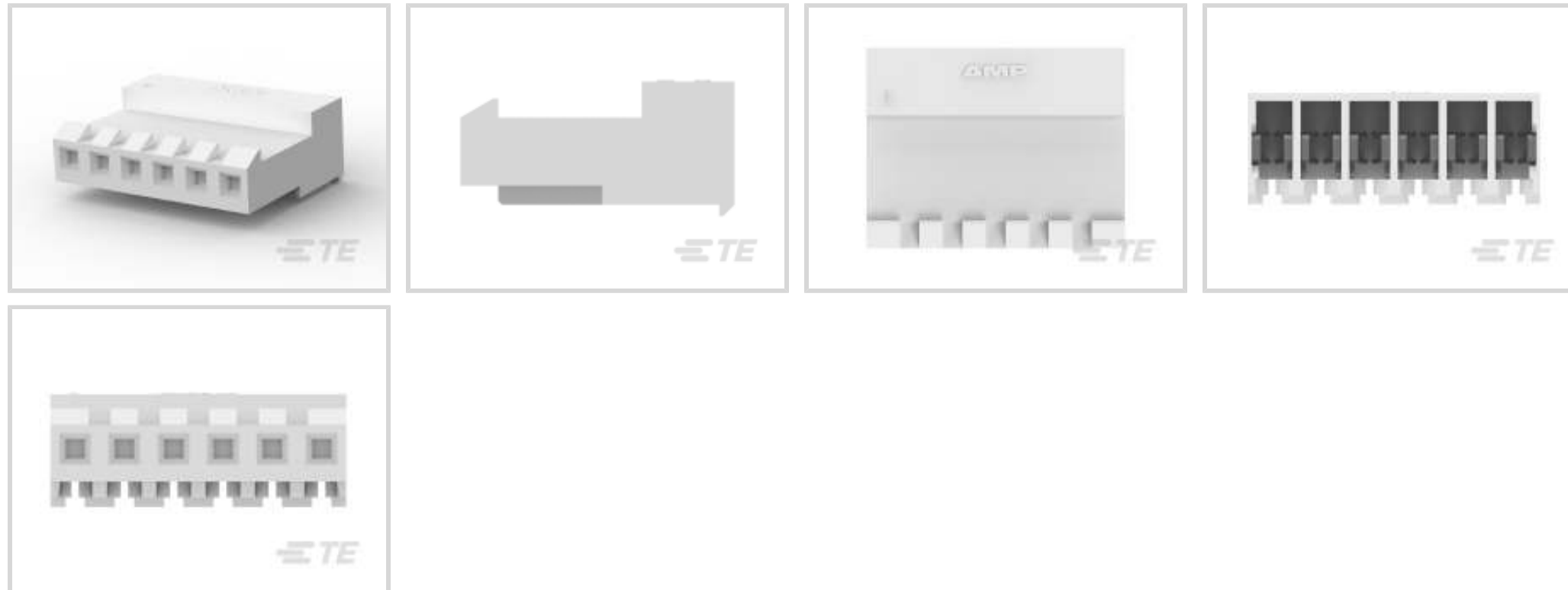

Rectangular Power Connector Type: **Connector Assembly**

Connector & Housing Type: **Receptacle**

Connector System: **Wire-to-Board**

Number of Positions: **6**

Centerline (Pitch): **3.96 mm [.156 in]**

## Features

### Product Type Features

Compatible With Discrete Wire Type	Stranded
Rectangular Power Connector Type	Connector Assembly
Connector & Housing Type	Receptacle
Connector System	Wire-to-Board
Sealable	No
Connector & Contact Terminates To	Wire & Cable

### Configuration Features

Number of Positions	6
Number of Power Positions	6
Number of Rows	1

### Electrical Characteristics

Operating Voltage	600 VAC
-------------------	---------

### Body Features

Cable Exit Angle	90°
------------------	-----



Connector Profile	Standard
-------------------	----------

### Contact Features

Contact Layout	Inline
Contact Underplating Material Thickness	30 $\mu\text{m}$ [.762 $\mu\text{in}$ ]
Wire Contact Termination Area Plating Thickness	2.03 – 5.08 $\mu\text{m}$ [80 – 200 $\mu\text{in}$ ]
Contact Mating Area Plating Material	Tin
Contact Underplating Material	Nickel
Contact Base Material	Copper Alloy
Contact Current Rating (Max)	7 A
Contact Retention Within Housing	With
Contact Type	Receptacle
Wire Contact Termination Area Plating Material	Tin
Contact Mating Area Plating Material Thickness	2.03 – 5.08 $\mu\text{m}$ [80 – 200 $\mu\text{in}$ ]

### Termination Features

Termination Method to Wire & Cable	Insulation Displacement (IDC)
------------------------------------	-------------------------------

### Mechanical Attachment

Strain Relief	With
Mating Retention	With
Mating Alignment	Without
Contact Retention Type Within Housing	Locking Lance
PCB Mount Alignment	Without
Panel Mount Feature	Without
PCB Mount Retention	Without
Mating Retention Type	Locking Ramp
Connector Mounting Type	Cable Mount (Free-Hanging)

### Housing Features

Wire & Cable IDC Installation Type	Closed End
Centerline (Pitch)	3.96 mm [.156 in]
Housing Color	White
Housing Material	Nylon

### Dimensions

Connector Height	9.02 mm [.355 in]
------------------	-------------------



Product Length	23.77 mm[.936 in]
----------------	-------------------

Compatible Insulation Diameter Range	2.41 mm[.095 in]
--------------------------------------	------------------

Wire Size	.2 mm <sup>2</sup>
-----------	--------------------

### Usage Conditions

Operating Temperature Range	-55 – 105 °C[-67 – 221 °F]
-----------------------------	----------------------------

### Operation/Application

Circuit Application	Power & Signal
---------------------	----------------

### Industry Standards

CSA Rating	Certified, LR 7189
------------	--------------------

UL Rating	Recognized
-----------	------------

Agency/Standard	CSA, UL
-----------------	---------

Approved Standards	UL E28476
--------------------	-----------

UL Flammability Rating	UL 94V-2
------------------------	----------

Glow Wire Rating	Standard Part - Not Glow Wire
------------------	-------------------------------

### Packaging Features

Packaging Quantity	250
--------------------	-----

Packaging Method	Bag & Box
------------------	-----------

### Product Compliance

[For compliance documentation, visit the product page on TE.com>](#)

EU RoHS Directive 2011/65/EU	Compliant
------------------------------	-----------

EU ELV Directive 2000/53/EC	Compliant
-----------------------------	-----------

China RoHS 2 Directive MIIT Order No 32, 2016	No Restricted Materials Above Threshold
---	---

EU REACH Regulation (EC) No. 1907/2006	Current ECHA Candidate List: JUNE 2023 (235) Candidate List Declared Against: JAN 2023 (233) Does not contain REACH SVHC
--	--

Halogen Content	Low Halogen - Br, Cl, F, I < 900 ppm per homogenous material. Also BFR/CFR/PVC Free
-----------------	---

Solder Process Capability	Not applicable for solder process capability
---------------------------	--

#### Product Compliance Disclaimer

This information is provided based on reasonable inquiry of our suppliers and represents our current actual knowledge based on the information they provided. This information is subject to change. The part numbers that TE has identified as

EU RoHS compliant have a maximum concentration of 0.1% by weight in homogenous materials for lead, hexavalent chromium, mercury, PBB, PBDE, DBP, BBP, DEHP, DIBP, and 0.01% for cadmium, or qualify for an exemption to these limits as defined in the Annexes of Directive 2011/65/EU (RoHS2). Finished electrical and electronic equipment products will be CE marked as required by Directive 2011/65/EU. Components may not be CE marked. Additionally, the part numbers that TE has identified as EU ELV compliant have a maximum concentration of 0.1% by weight in homogenous materials for lead, hexavalent chromium, and mercury, and 0.01% for cadmium, or qualify for an exemption to these limits as defined in the Annexes of Directive 2000/53/EC (ELV). Regarding the REACH Regulation, the information TE provides on SVHC in articles for this part number is based on the latest European Chemicals Agency (ECHA) 'Guidance on requirements for substances in articles' posted at this URL: <https://echa.europa.eu/guidance-documents/guidance-on-reach>

## Compatible Parts

 <p>TE Part # 58074-1 MTA 50/100/156 MANUAL TOOL FRAME</p>	 <p>TE Part # 59804-1 MAINTENANCE TOOL</p>	 <p>TE Part # 3-641437-6 06P MTA156 PSTD CONN ASSY RED</p>	 <p>TE Part # 640389-6 06P MTA156 HDR ASSY SQ R/A F/L</p>
 <p>TE Part # 643067-6 06P MTA156 MOLDED COVER</p>	 <p>TE Part # 640551-6 06P MTA156 COVER</p>	 <p>TE Part # 644752-6 06P MTA156 HDR ASSY SQ STR F/L</p>	 <p>TE Part # 640384-6 06P MTA156 HDR ASSY STR RND SN</p>
 <p>TE Part # 640388-6 06P MTA156 HDR ASSY RN STR F/L</p>	 <p>TE Part # 640385-6 06P MTA156 HDR ASSY SQ R/A</p>	 <p>TE Part # 640643-6 06P MTA156 COVER F/T</p>	 <p>TE Part # 640383-6 06P MTA156 HDR ASSY STR SQ SN</p>
 <p>TE Part # 640445-6 06P MTA156 HDR ASSY FL/STR SN</p>	 <p>TE Part # 3-641436-6 06P MTA156 PST CONN ASSY LF</p>	 <p>TE Part # 3-644615-6 06P MTA156 POL HDR ASSY LF</p>	 <p>TE Part # 3-641435-6 06P MTA156 CONN ASSY ORNG</p>



TE Part # 643071-6  
06P MTA156 FD-THRU COVER



TE Part # 644753-6  
06P MTA156 HDR ASSY RN STR F/L



TE Part # 3-641438-6  
06P MTA156 PSTD CONN ASSY WHT



TE Part # 2-647123-6  
06P MTA156 SHRD HDR ASSY SQ SN

Also in the Series | **MTA 156**

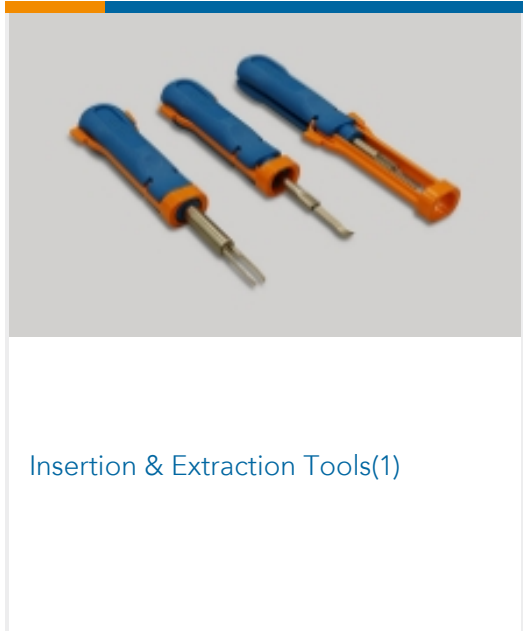

Insertion & Extraction Tools(1)

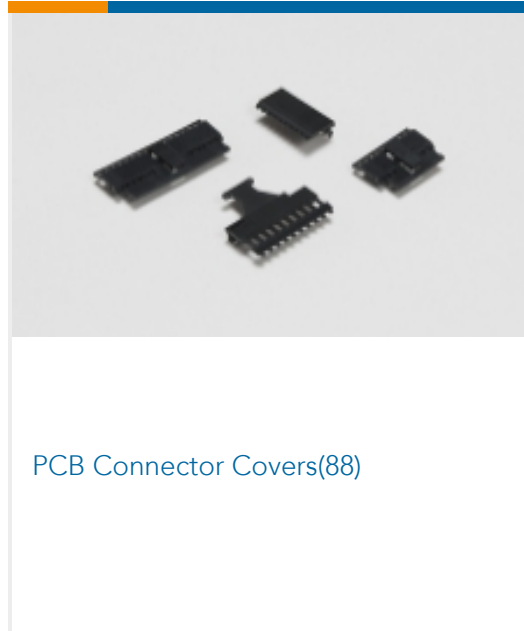

PCB Connector Covers(88)



PCB Connector Keying(2)

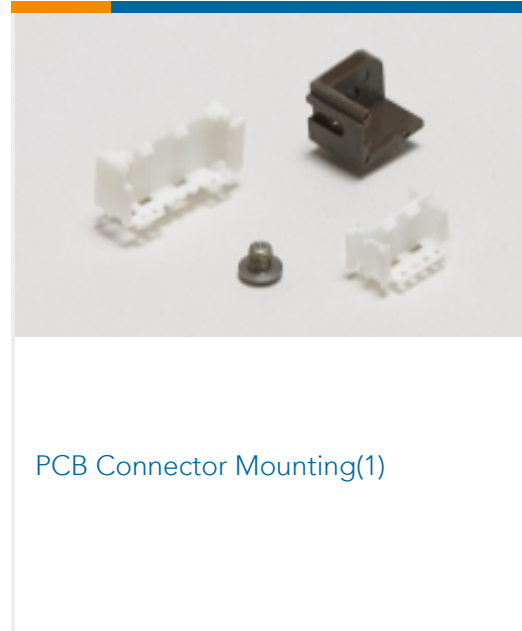

PCB Connector Mounting(1)



PCB Headers & Receptacles(316)

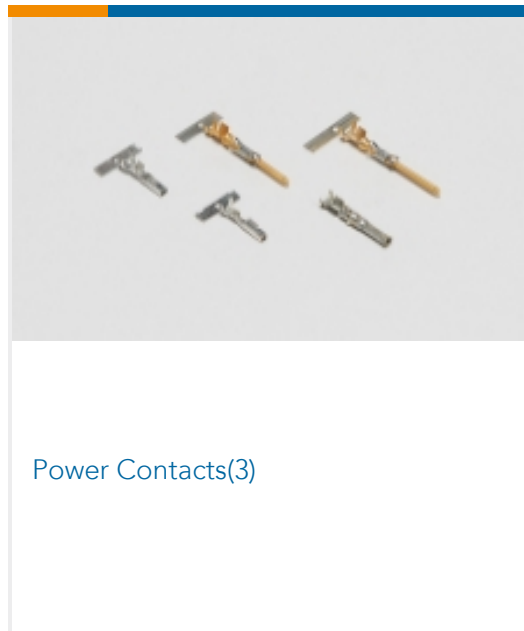

Power Contacts(3)



Rectangular Power Connectors(699)

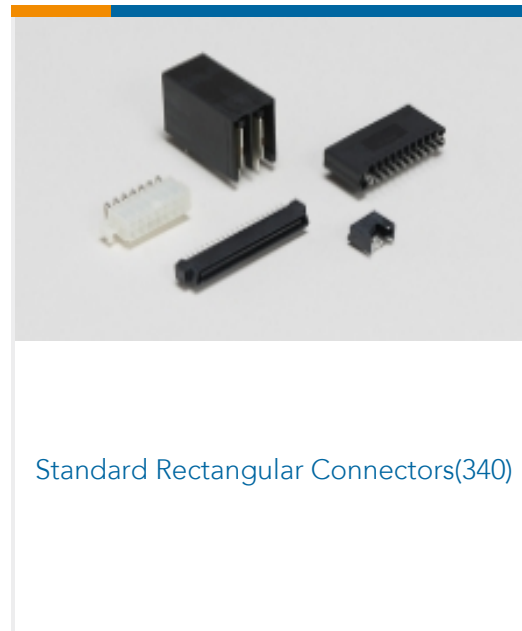

Standard Rectangular Connectors(340)

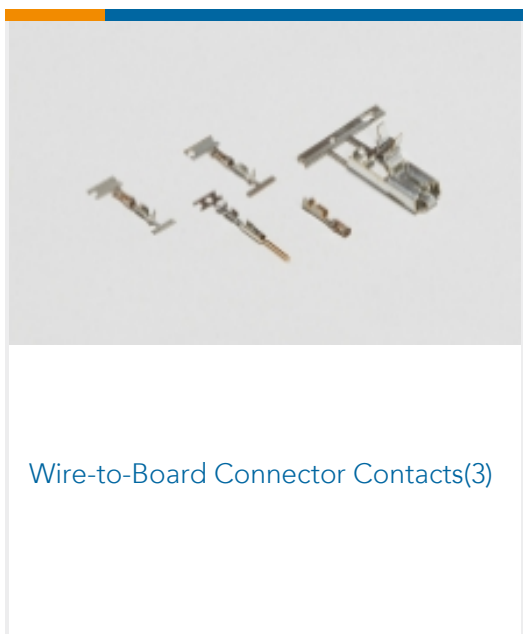

Wire-to-Board Connector Contacts(3)

Customers Also Bought



TE Part #640909-1  
RECEPT,PIDG FASTON 22-18 205

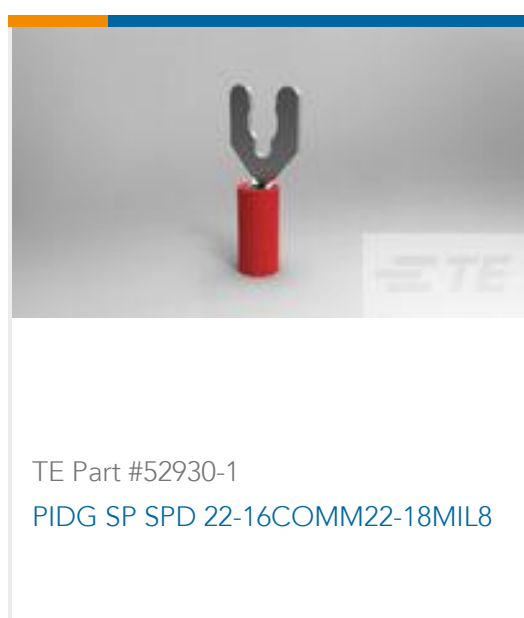

TE Part #52930-1  
PIDG SP SPD 22-16COMM22-18MIL8

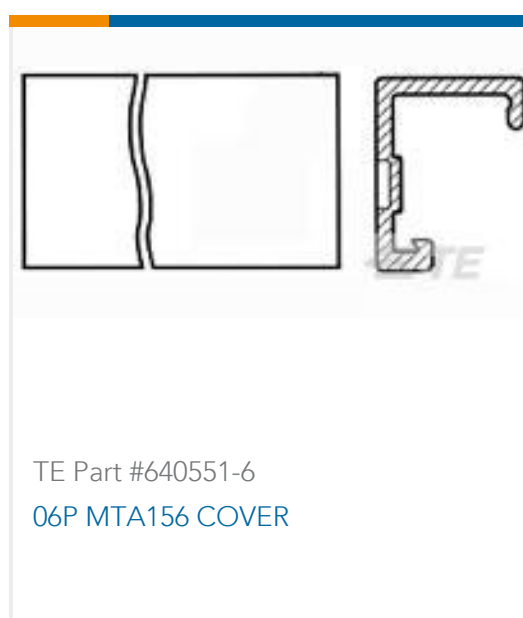

TE Part #640551-6  
06P MTA156 COVER



TE Part #3-640429-2  
02P MTA156 CONN ASSY 24AWG WHT

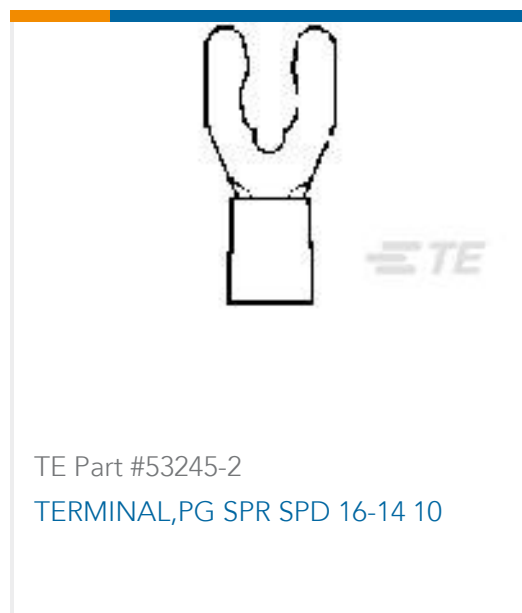

## Documents

### Product Drawings

06P MTA156 CONN ASSY 24AWG WHT

English

### CAD Files

3D PDF

English

Customer View Model

[ENG\\_CVM\\_3-640429-6\\_S.2d\\_dxf.zip](#)

English

Customer View Model

[ENG\\_CVM\\_3-640429-6\\_S.3d\\_igs.zip](#)

English

Customer View Model

[ENG\\_CVM\\_3-640429-6\\_S.3d\\_stp.zip](#)

English

3D PDF

3D

Customer View Model

[ENG\\_CVM\\_CVM\\_3-640429-6\\_N.2d\\_dxf.zip](#)

English

Customer View Model

[ENG\\_CVM\\_CVM\\_3-640429-6\\_N.3d\\_igs.zip](#)

English

Customer View Model

[ENG\\_CVM\\_CVM\\_3-640429-6\\_N.3d\\_stp.zip](#)

English



By downloading the CAD file I accept and agree to the [Terms and Conditions](#) of use.

---

## Product Specifications

### Product Specification

English

---

## Product Environmental Compliance

### Product Compliance Document

English

### Product Compliance Document

English

---

## Agency Approvals

### CSA Certificate

English