



## Clock Oscillator SMD-version

+3,3V

|                                     |  |
|-------------------------------------|--|
| model                               | KXO-V97T                               |
| frequency                           | 27,0 MHz                               |
| frequency stability at -40° ~ +85°C | ± 100 ppm                              |
| operating temperature               | -40° ~ +85°C                           |
| storage temperature                 | -40° ~ +85°C                           |
| symmetry                            | 50% ± 10% at 1/2 V <sub>DD</sub> level |
| rise & fall time max.               | 6 ns                                   |
| "0" level max.                      | + 0,4V                                 |
| "1" level min.                      | V <sub>DD</sub> -0,5V                  |
| input voltage V <sub>DD</sub>       | + 3,3V ± 10%                           |
| input current                       | 6,0 mA typ., 11,0 mA max.              |
| output load                         | 30 pF                                  |
| start up time max.                  | 10 ms                                  |
| tristate function                   | yes                                    |
| disable delay time                  | 100 ns max.                            |
| enable delay time                   | 4 ms max.                              |
| random jitter                       | 7ps max.                               |
| peak to peak jitter                 | 40ps max.                              |
| contents of reel                    | 1000 pcs.                              |
| part no.                            | 12.94474                               |

### Dimensions (mm):

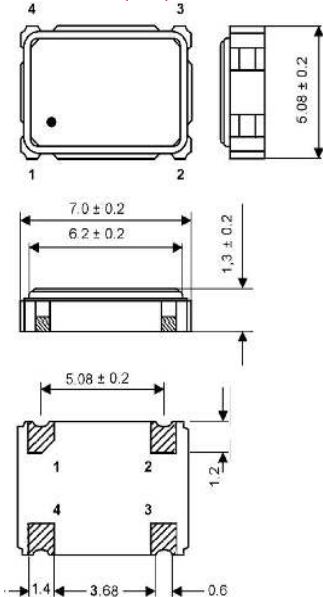

| PIN | CONNECTION           |
|-----|----------------------|
| 1   | "L" (OV) "H" or OPEN |
| 2   | GND                  |
| 3   | OUTPUT               |
| 4   | V <sub>DD</sub>      |

Z: high impedance

### Output waveform:

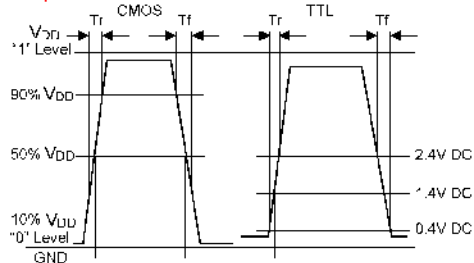

### Reflow soldering condition:

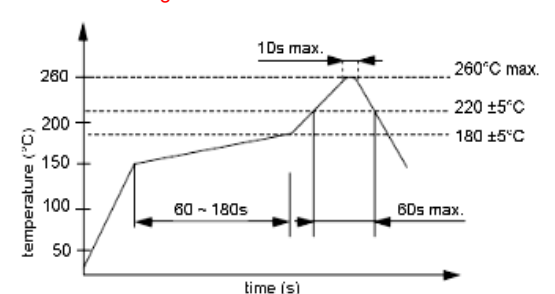

### Test circuit:

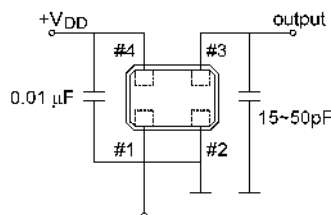

### Tape specifications:

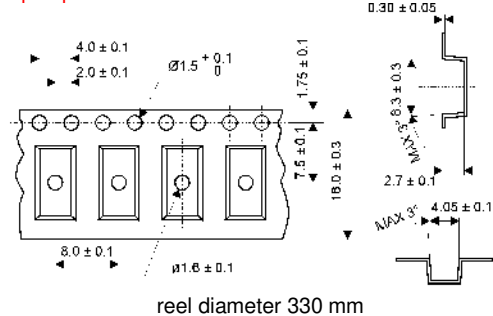

### Suggested soldering pad:

