

Description: 25x25x4mm GPS/Glonass Pin Mount

Series: Ceramic Patch

PART NUMBER: W3223



Features:

- 1575/1602MHz Dualband single feed antenna
- RHCP Polarization
- Zenith Gain +4dBiC
- Pin mounting
- Tray packing
- Moisture sensitivity level:MSL1

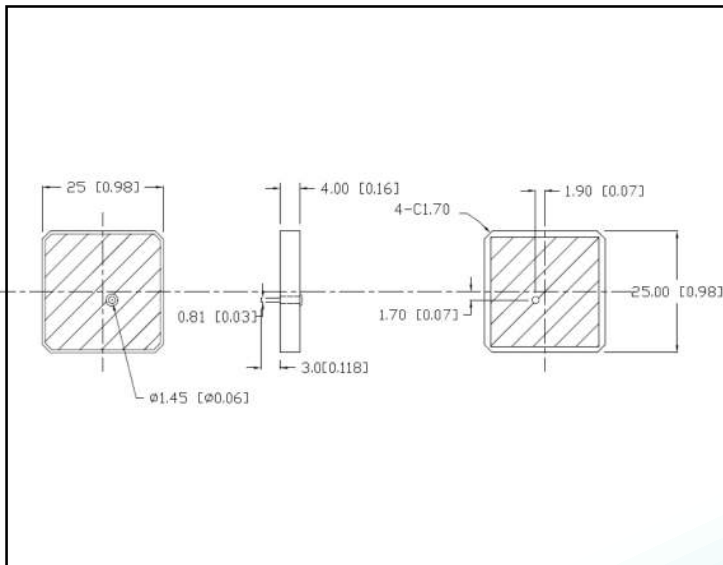

Applications:

- GPS and Glonass satellite receivers
- Tracking, Navigation, Satellite Positioning
- Fleet management
- Asset tracking

All dimensions are in mm / inches

Issue: 1910

In the effort to improve our products, we reserve the right to make changes judged to be necessary.

CONFIDENTIAL AND PROPRIETARY INFORMATION

This document contains confidential and proprietary information of Pulse Electronics, Inc. (Pulse) and is protected by copyright, trade secret and other state and federal laws. Its receipt or possession does not convey any rights to reproduce, disclose its contents, or to manufacture, use or sell anything it may describe. Reproduction, disclosure or use without specific written authorization of Pulse is strictly forbidden.

For more information:

Pulse Worldwide Headquarters
12220 World Trade Drive
San Diego, CA 92128
USA
Tel:1-858-674-8100

Pulse/Larsen Antennas
18110 SE 34th St Bldg 2 Suite 250
Vancouver, WA 98683
USA
Tel: 1-360-944-7551

Europe Headquarters
Pulse GmbH & Do, KG
Zeppelinstrasse 15
Herrenberg, Germany
Tel: 49 7032 7806 0

Pulse (Suzhou) Wireless Products Co, Inc.
99 Huo Ju Road(#29 Bldg,4th Phase
Suzhou New District
Jiangsu Province, Suzhou 215009 PR China
Tel: 86 512 6807 9998



Description: 25x25x4mm GPS/Glonass Pin Mount

Series: Ceramic Patch

PART NUMBER: W3223

ELECTRICAL SPECIFICATIONS

Frequency	1575.42±1.023/1602.5625±4 MHz
Nominal Impedance	50 Ω
Return Loss*	<-10 dB
RHCP Gain (typical)*	4 dBiC
Zenith Axial Ratio(typical)*	3.8
Polarization:	RHCP

* Measured on 70 x 70 mm reference board

* Test the antenna on 70mmX70mm metal plane

Issue: 1910

In the effort to improve our products, we reserve the right to make changes judged to be necessary.

CONFIDENTIAL AND PROPRIETARY INFORMATION

This document contains confidential and proprietary information of Pulse Electronics, Inc. (Pulse) and is protected by copyright, trade secret and other state and federal laws. Its receipt or possession does not convey any rights to reproduce, disclose its contents, or to manufacture, use or sell anything it may describe. Reproduction, disclosure or use without specific written authorization of Pulse is strictly forbidden.

Description: 25x25x4mm GPS/Glonass Pin Mount

Series: Ceramic Patch

PART NUMBER: W3223

MECHANICAL SPECIFICATIONS

Material	Ceramic
Metallization	Silver
Size	25 x 24 x 4 mm
Weight	9.3 g
Mounting type	Pin feed

ENVIRONMENTAL SPECIFICATIONS

Operating temperature	-40/+85 ° C
-----------------------	-------------

Issue: 1910

In the effort to improve our products, we reserve the right to make changes judged to be necessary.

CONFIDENTIAL AND PROPRIETARY INFORMATION

This document contains confidential and proprietary information of Pulse Electronics, Inc. (Pulse) and is protected by copyright, trade secret and other state and federal laws. Its receipt or possession does not convey any rights to reproduce, disclose its contents, or to manufacture, use or sell anything it may describe. Reproduction, disclosure or use without specific written authorization of Pulse is strictly forbidden.

Description: 25x25x4mm GPS/Glonass Pin Mount

Series: Ceramic Patch

PART NUMBER: W3223

MECHANICAL DRAWING

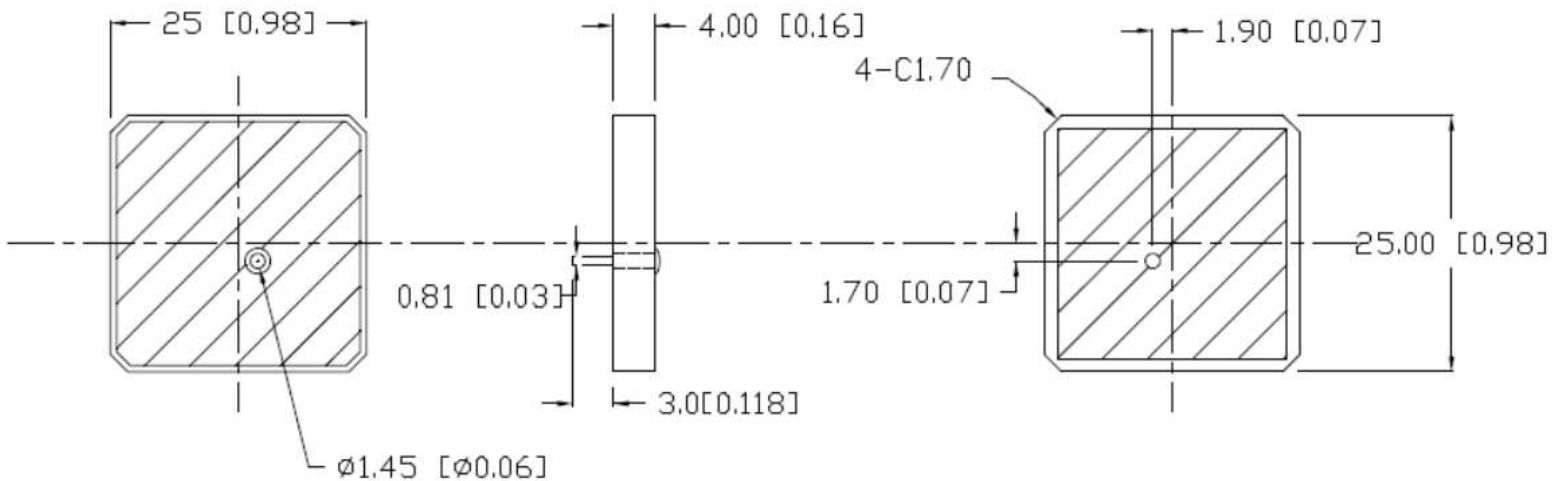

Adhesive Transfer Tape Specification

TAPE: Nitto 5000NS 22*22*0.16mm

Thickness : $0.16 \pm 5\%$ mm

Release Liner : 0.1mm (typ.) printed paper or paper

Dimension : mm

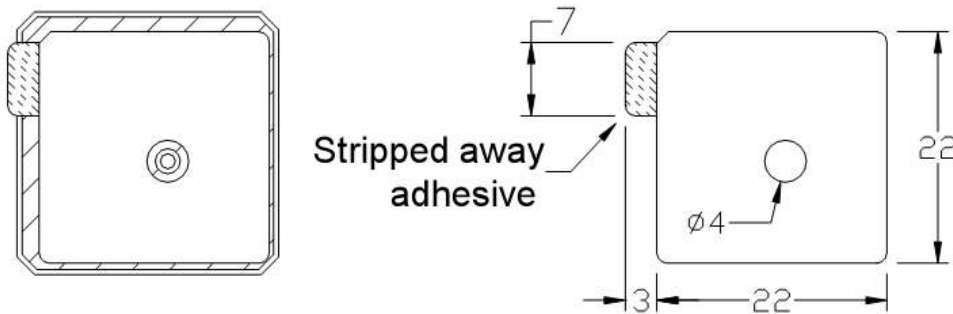

Patch bottom

Tolerance: ± 0.2 mm

Issue: 1910

In the effort to improve our products, we reserve the right to make changes judged to be necessary.

CONFIDENTIAL AND PROPRIETARY INFORMATION

This document contains confidential and proprietary information of Pulse Electronics, Inc. (Pulse) and is protected by copyright, trade secret and other state and federal laws. Its receipt or possession does not convey any rights to reproduce, disclose its contents, or to manufacture, use or sell anything it may describe. Reproduction, disclosure or use without specific written authorization of Pulse is strictly forbidden.

Description: 25x25x4mm GPS/Glonass Pin Mount

Series: Ceramic Patch

PART NUMBER: W3223

OTHER SPECIFICATIONS

Test Condition Ground Plane (Example for PCB 1 mm)

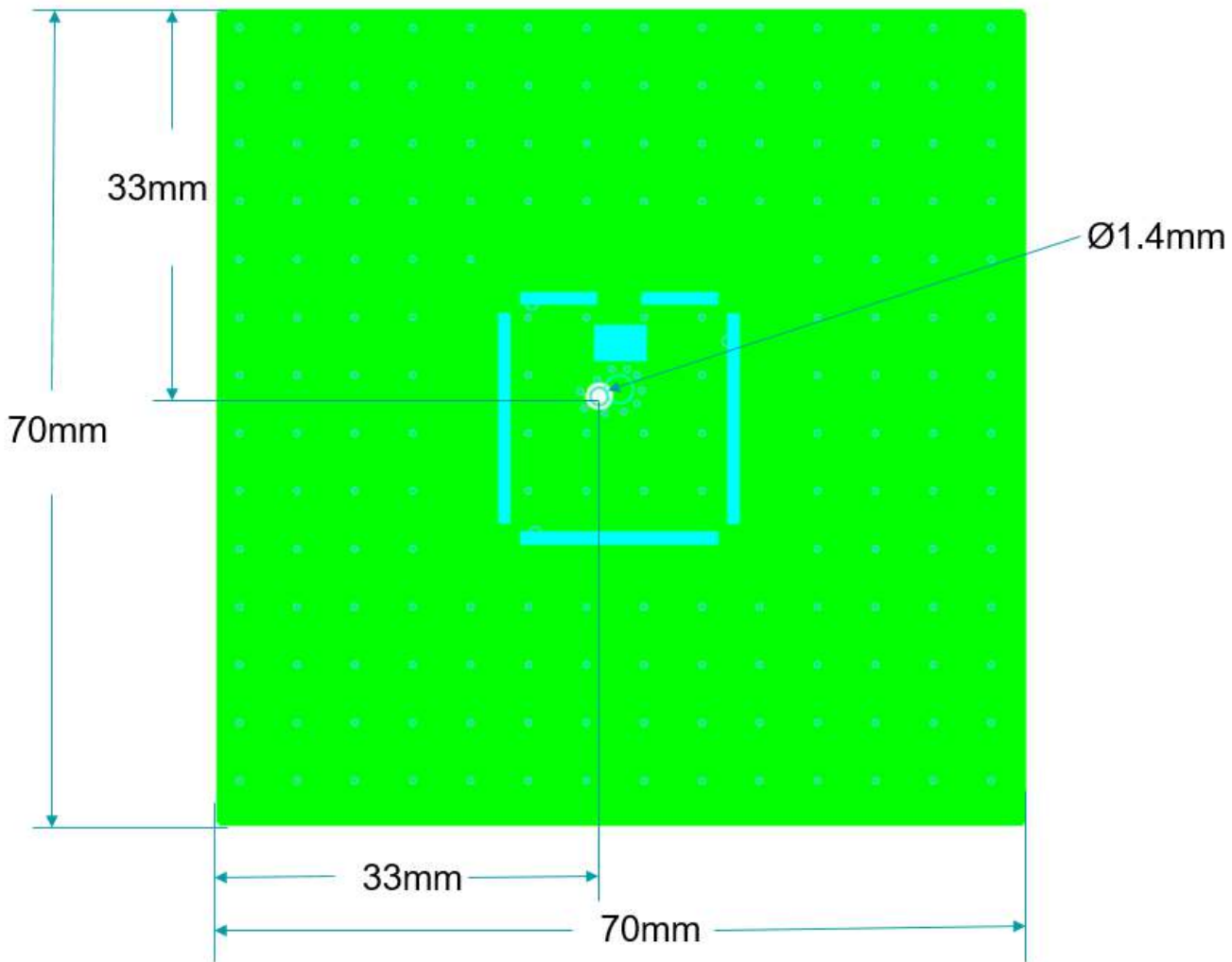

Description: 25x25x4mm GPS/Glonass Pin Mount

Series: Ceramic Patch

PART NUMBER: W3223

CHARTS

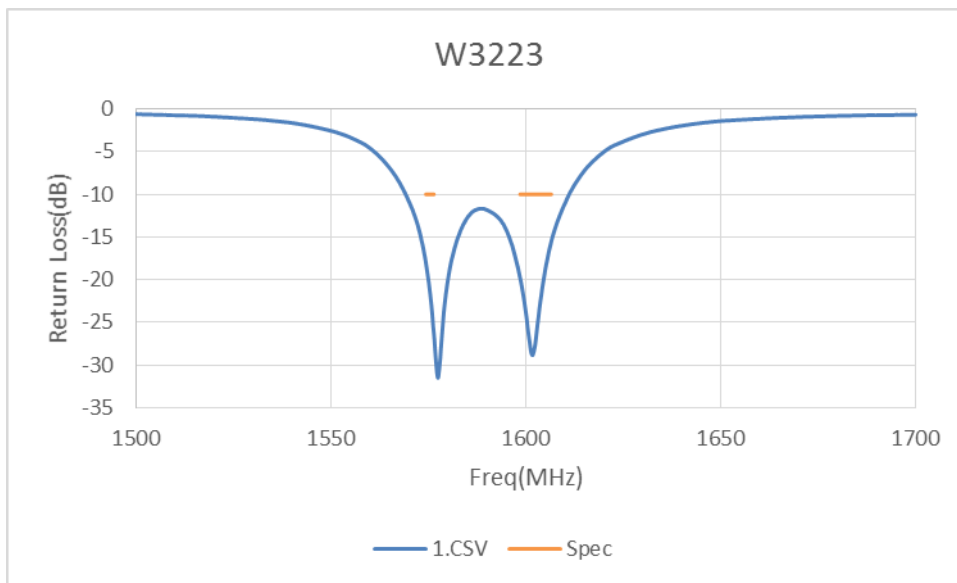

Return Loss

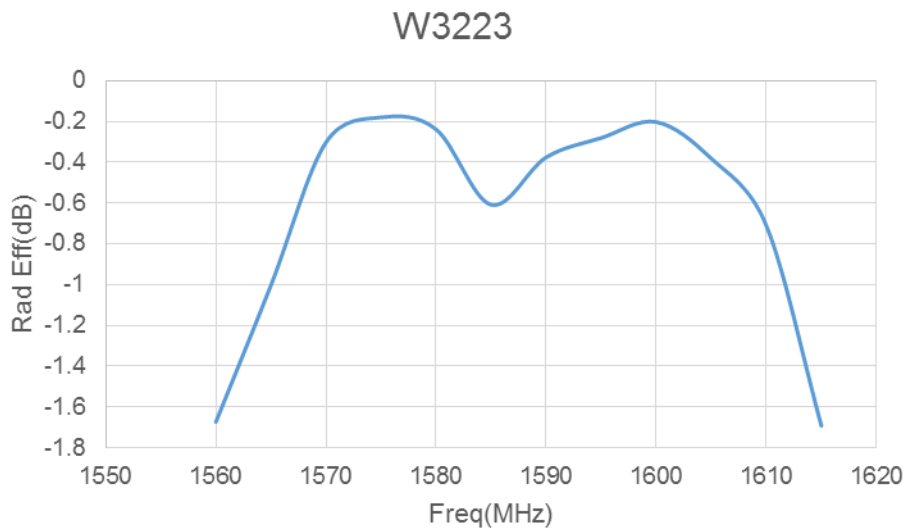

Total Radiation Efficiency

Issue: 1910

In the effort to improve our products, we reserve the right to make changes judged to be necessary.

CONFIDENTIAL AND PROPRIETARY INFORMATION

This document contains confidential and proprietary information of Pulse Electronics, Inc. (Pulse) and is protected by copyright, trade secret and other state and federal laws. Its receipt or possession does not convey any rights to reproduce, disclose its contents, or to manufacture, use or sell anything it may describe. Reproduction, disclosure or use without specific written authorization of Pulse is strictly forbidden.

Description: 25x25x4mm GPS/Glonass Pin Mount

Series: Ceramic Patch

PART NUMBER: W3223

CHARTS

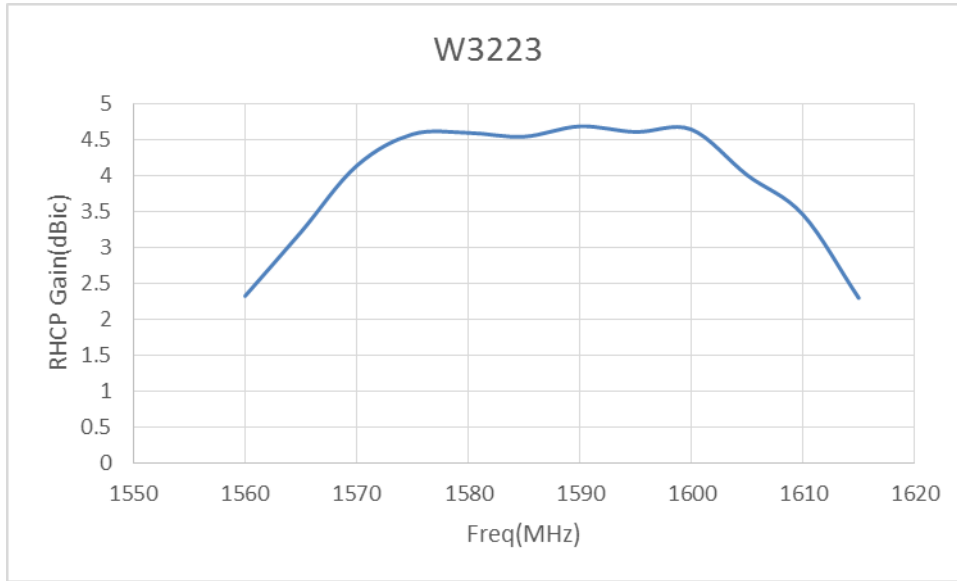

Zenith RHCP Gain

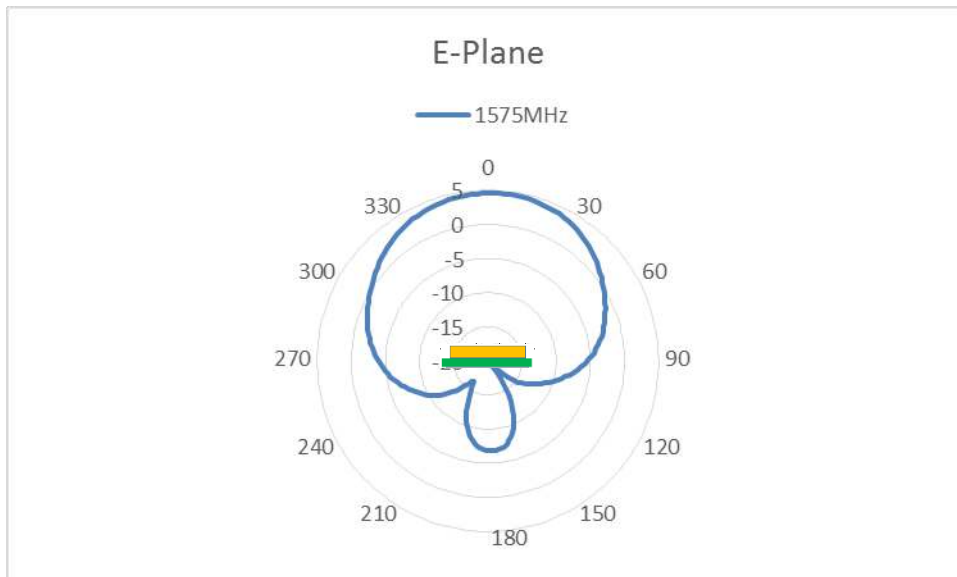

GPS Radiation pattern on 70mmX70mm metal plane

Issue: 1910

In the effort to improve our products, we reserve the right to make changes judged to be necessary.
CONFIDENTIAL AND PROPRIETARY INFORMATION

This document contains confidential and proprietary information of Pulse Electronics, Inc. (Pulse) and is protected by copyright, trade secret and other state and federal laws. Its receipt or possession does not convey any rights to reproduce, disclose its contents, or to manufacture, use or sell anything it may describe. Reproduction, disclosure or use without specific written authorization of Pulse is strictly forbidden.

Description: 25x25x4mm GPS/Glonass Pin Mount

Series: Ceramic Patch

PART NUMBER: W3223

CHARTS

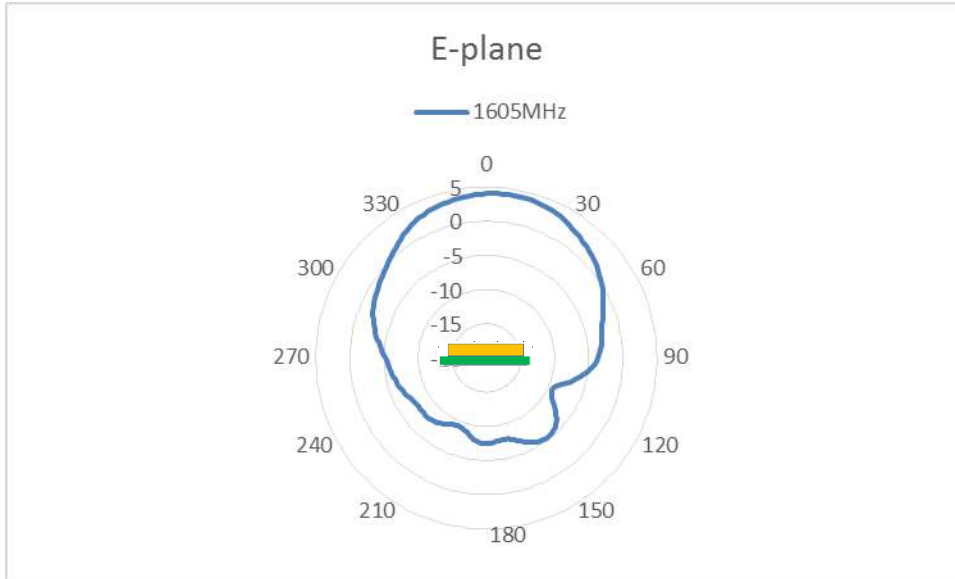

Glonass Radiation pattern on 70mmX70mm metal plane

Description: 25x25x4mm GPS/Glonass Pin Mount

Series: Ceramic Patch

PART NUMBER: W3223

PACKAGING

Tray packing
50PCS/Tray
200PCS/small carton box
800PCS/big carton box
Big box dimensions (MM): 472x240x290

Issue: 1910

In the effort to improve our products, we reserve the right to make changes judged to be necessary.

CONFIDENTIAL AND PROPRIETARY INFORMATION

This document contains confidential and proprietary information of Pulse Electronics, Inc. (Pulse) and is protected by copyright, trade secret and other state and federal laws. Its receipt or possession does not convey any rights to reproduce, disclose its contents, or to manufacture, use or sell anything it may describe. Reproduction, disclosure or use without specific written authorization of Pulse is strictly forbidden.