

BQ21061 I²C Controlled 1-Cell 500-mA Linear Battery Charger With 10-nA Ship Mode, Power Path With Regulated System (PMID) Voltage, And LDO

1 Features

- Linear battery charger with 1.25-mA to 500-mA fast charge current range
 - 0.5% Accurate I²C programmable battery regulation voltage ranging from 3.6 V to 4.6 V in 10-mV steps
 - Configurable termination current supporting down to 0.5 mA
 - 20-V Tolerant input with typical 3.4-V to 5.5-V input voltage operating range
 - Programmable thermal charging profile, fully configurable hot, warm, cool and cold thresholds
- Power Path management for powering system and charging battery
 - I²C Programmable regulated system voltage (PMID) ranging from 4.4V to 4.9V in addition to battery voltage tracking and Input pass-through options
 - Dynamic power path management optimizes charging from weak adapters
 - Advanced I²C control allows host to disconnect the battery or adapter as needed
- I²C Configurable load switch or up to 150-mA LDO output
 - Programmable range from 0.6 V to 3.7 V in 100-mV steps
- Ultra low I_{ddq} for extended battery life
 - 10-nA Ship mode battery I_q
 - 400-nA I_q While powering the system (PMID and VDD on)
- One push-button wake-up and reset input with adjustable timers
- Safety-Related Certifications
 - TUV IEC 62368 Certification
- 20-Pin 2-mm x 1.6-mm CSP package
- 11-mm² Total solution size

2 Applications

- Headsets, earbuds and hearing aids
- Smart watches and smart trackers
- Wearable fitness and activity monitors
- Blood glucose monitors

3 Description

The BQ21061 is a highly integrated battery charge management IC that integrates the most common functions for wearable, portable and small medical devices, namely a charger, a regulated output voltage rail for system power, a LDO, and push-button controller.

The BQ21061 IC integrates a linear charger with Power Path that enables quick and accurate charging for small batteries while providing a regulated voltage to the system. The regulated system voltage (PMID) output may be configured through I²C based on the recommended operating condition of downstream IC's and system loads for optimal system operation.

Device Information

PART NUMBER	PACKAGE ⁽¹⁾	BODY SIZE (NOM)
BQ21061	DSBGA (20)	2.00 mm x 1.60 mm

(1) For all available packages, see the orderable addendum at the end of the data sheet.

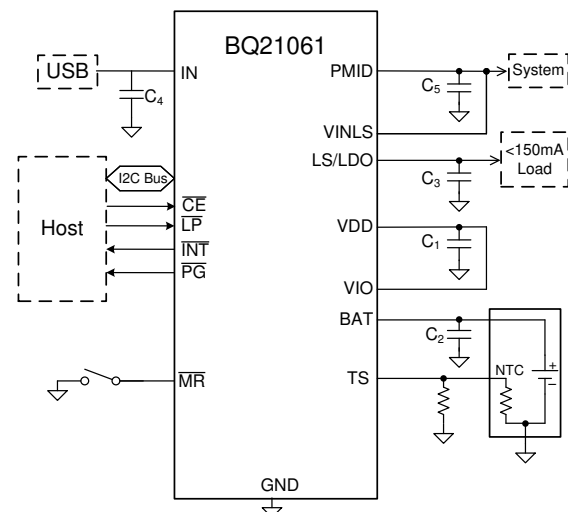

Simplified Schematic



Table of Contents

1 Features	1	7.5 Register Map.....	30
2 Applications	1	8 Application and Implementation	49
3 Description	1	8.1 Application Information.....	49
4 Revision History	2	8.2 Typical Application.....	49
5 Pin Configuration and Functions	3	9 Power Supply Recommendations	54
6 Specifications	5	10 Layout	55
6.1 Absolute Maximum Ratings.....	5	10.1 Layout Guidelines.....	55
6.2 ESD Ratings.....	5	10.2 Layout Example.....	55
6.3 Recommended Operating Conditions.....	5	11 Device and Documentation Support	56
6.4 Thermal Information.....	5	11.1 Device Support.....	56
6.5 Electrical Characteristics.....	6	11.2 Documentation Support.....	56
6.6 Timing Requirements.....	8	11.3 Receiving Notification of Documentation Updates..	56
6.7 Typical Characteristics.....	10	11.4 Support Resources.....	56
7 Detailed Description	13	11.5 Electrostatic Discharge Caution.....	56
7.1 Overview.....	13	11.6 Trademarks.....	56
7.2 Functional Block Diagram.....	13	11.7 Glossary.....	56
7.3 Feature Description.....	13	12 Mechanical, Packaging, and Orderable Information	57
7.4 Device Functional Modes.....	27		

4 Revision History

NOTE: Page numbers for previous revisions may differ from page numbers in the current version.

Changes from Revision * (September 2019) to Revision A (August 2023)	Page
• Updated the numbering format for tables, figures, and cross-references throughout the document.....	1
• Added Safety-Related Certifications to Features.....	1
• Added clarification to $\overline{\text{LP}}$ pin description.....	3
• Added clarification to LS/LDO pin description.....	3
• Changed maximum I_{PMID} in Recommended Operating Conditions.....	5
• Changed $t_{\text{HW_RESET_WD}}$ test conditions and MAX value from 15s to 14s in Timing Requirements.....	8
• Changed $t_{\text{RESET_WARN}}$ and $t_{\text{HW_RESET}}$ parameters.....	8
• Changed $t_{\text{HW_RESET_WARN}}$ to $t_{\text{RESET_WARN}}$ and VIN presence to valid VIN presence in Section 7.3.7.2	19
• Added clarification to TS biasing operation.....	22
• Changed from as well while the VIN input is valid to while the VIN input is valid in Section 7.4.1	27
• Changed description of IBAT_OCP_ILIM 2b10 setting to "Disable" to describe correct behavior.....	30
• Changed clarification to TS_EN bit functionality.....	30
• Changed Figure 8-3	51

5 Pin Configuration and Functions

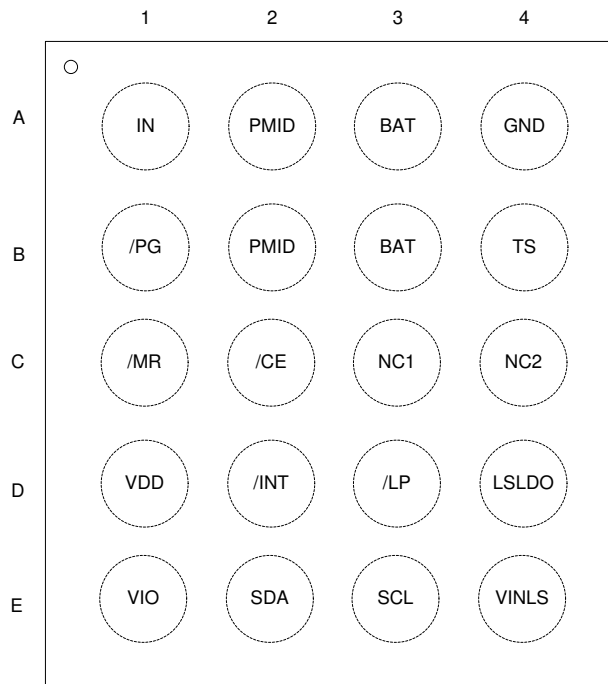

Figure 5-1. YFP Package 20-Pin DSBGA Top View

Table 5-1. Pin Functions

PIN		I/O	DESCRIPTION
NAME	NO.		
IN	A1	I	DC Input Power Supply. IN is connected to the external DC supply. Bypass IN to GND with at least 1- μ F of capacitance using a ceramic capacitor.
PMID	A2, B2	I/O	Regulated System Output. Connect 22- μ F capacitor from PMID to GND as close to the PMID and GND pins as possible. If operating in VIN Pass-Through Mode (PMID_REG = 111) a lower capacitor value may be used (at least 3- μ F of ceramic capacitance with DC bias de-rating).
GND	A4	PWR	Ground connection. Connect to the ground plane of the circuit.
VDD	D1	O	Digital supply LDO. Connect a 2.2- μ F from this pin to ground.
\overline{CE}	C2	I	Charge Enable. Drive \overline{CE} low or leave disconnected to enable charging when VIN is valid. \overline{CE} is pulled low internally with 900-k Ω resistor.
SCL	E3	I/O	I ² C Interface Clock. Connect SCL to the logic rail through a 10-k Ω resistor.
SDA	E2	I	I ² C Interface Data. Connect SDA to the logic rail through a 10-k Ω resistor.
\overline{LP}	D3	I	Low Power Mode Enable. Drive this pin low to set the device in low power mode when powered by the battery. This pin must be driven high to allow I ² C communication when VIN is not present. \overline{LP} is pulled low internally with 900-k Ω resistor. This pin has no effect when VIN is present.
\overline{INT}	D2	O	\overline{INT} is an open-drain output that signals fault interrupts. When a fault occurs, a 128- μ s pulse is sent out as an interrupt for the host.
\overline{MR}	C1	I	Manual Reset Input. \overline{MR} is a general purpose input used to reset the device or to wake it up from Ship Mode. \overline{MR} has in internal 125-k Ω pull-up resistor to BAT.
LS/LDO	D4	O	Load Switch or LDO output. Connect 2.2 μ F of ceramic capacitance to this pin to assure stability. Be sure to account for capacitance bias voltage derating when selecting the capacitor. If LDO is not used, short to VINLS
VINLS	E4	I	Input to the Load Switch / LDO output. Connect at least 1 μ F of ceramic capacitance from this pin to ground.
BAT	A3, B3	I/O	Battery Connection. Connect to the positive terminal of the battery. Bypass BAT to GND with at least 1 μ F of ceramic capacitance.

Table 5-1. Pin Functions (continued)

PIN		I/O	DESCRIPTION
NAME	NO.		
TS	B4	I	Battery Pack NTC Monitor. Connect TS to a 10-k Ω NTC thermistor in parallel to a 10-k Ω resistor. If TS function is not to be used connect a 5-k Ω resistor from TS to ground.
$\overline{\text{PG}}$	B1	O	Open-drain Power Good status indication output. The $\overline{\text{PG}}$ pin can also be configured as a general purpose open drain output or level shifter version of $\overline{\text{MR}}$.
VIO	E1	I	System IO supply. Connect to system IO supply to allow level shifting of input signals (SDA, SCL, LP and CE) to the device internal digital domain. Connect to VDD when external IO supply is not available.
NC1	C3	I	No Connect. Connect to ground if possible for better thermal dissipation or leave floating. Do not connect to a any voltage source or signal to avoid higher quiescent current.
NC2	C4	I	No Connect. Connect to ground if possible for better thermal dissipation. May be shorted to /LP for easier routing as long as Absolute Maximum Rating requirements are met..

6 Specifications

6.1 Absolute Maximum Ratings

over operating free-air temperature range (unless otherwise noted)⁽¹⁾

		MIN	MAX	UNIT
Voltage	IN	-0.3	20	V
	TS, VDD, NC	-0.3	1.95	V
	All other pins	-0.3	5.5	V
Current	IN	0	800	mA
	BAT, PMID	-0.5	1.5	A
	INT, $\overline{\text{PG}}$	0	10	mA
Junction temperature, T_J		-40	125	°C
Storage temperature, T_{stg}		-55	150	°C

- (1) Stresses beyond those listed under *Absolute Maximum Rating* may cause permanent damage to the device. These are stress ratings only, which do not imply functional operation of the device at these or any other conditions beyond those indicated under *Recommended Operating Condition*. Exposure to absolute-maximum-rated conditions for extended periods may affect device reliability.

6.2 ESD Ratings

		VALUE	UNIT
$V_{\text{(ESD)}}$ Electrostatic discharge	Human body model (HBM), per ANSI/ESDA/ JEDEC JS-001, all pins ⁽¹⁾	±2000	V
	Charged device model (CDM), per JEDEC specification JESD22-C101, all pins ⁽²⁾	±500	

- (1) JEDEC document JEP155 states that 500-V HBM allows safe manufacturing with a standard ESD control process.
 (2) JEDEC document JEP157 states that 250-V CDM allows safe manufacturing with a standard ESD control process.

6.3 Recommended Operating Conditions

over operating free-air temperature range (unless otherwise noted)

		MIN	NOM	MAX	UNIT
V_{BAT}	Battery voltage range	2.4		4.6	V
V_{IN}	Input voltage range	3.15		5.25 ⁽¹⁾	V
V_{INLS}	LDO input voltage range	2.2		5.25 ⁽¹⁾	V
V_{IO}	IO supply voltage range	1.2		3.6	V
I_{LDO}	LDO output current	0		100	mA
I_{PMID}	PMID output current	0		1.5	A
T_A	Operating free-air temperature range	-40		85	°C

- (1) Based on minimum V_{OVP} value. 5.5V under typical conditions

6.4 Thermal Information

THERMAL METRIC ⁽¹⁾		BQ21061	UNIT
		YFP (DSBGA)	
		20-PIN	
$R_{\theta\text{JA}}$	Junction-to-ambient thermal resistance ⁽²⁾	36.1	°C/W
$R_{\theta\text{JA}}$	Junction-to-ambient thermal resistance	74.4	°C/W
$R_{\theta\text{JC(top)}}$	Junction-to-case (top) thermal resistance	0.5	°C/W
$R_{\theta\text{JB}}$	Junction-to-board thermal resistance	17.6	°C/W
Ψ_{JT}	Junction-to-top characterization parameter	0.3	°C/W
Ψ_{JB}	Junction-to-board characterization parameter	17.7	°C/W

6.4 Thermal Information (continued)

THERMAL METRIC ⁽¹⁾	BQ21061		UNIT
	YFP (DSBGA)		
	20-PIN		
R _{θJC(bot)}	Junction-to-case (bottom) thermal resistance	N/A	°C/W

- (1) For more information about traditional and new thermal metrics, see the [Semiconductor and IC Package Thermal Metrics](#) application report.
- (2) Measured in BQ21061EVM board.

6.5 Electrical Characteristics

V_{IN} = 5V, V_{BAT} = 3.6V. T_J = 25°C unless otherwise noted.

PARAMETER	TEST CONDITIONS	MIN	TYP	MAX	UNIT	
INPUT CURRENTS						
I _{IN}	Input supply current	PMID_MODE = 01, V _{IN} = 5V, V _{BAT} = 3.6V		500	μA	
		V _{IN} = 5V, V _{BAT} = 3.6V Charge Disabled		1.6	mA	
I _{BAT_SHIP}	Battery Discharge Current in Ship Mode	V _{IN} = 0V, V _{BAT} = 3.6V		10	nA	
I _{BAT_LP}	Battery Quiescent Current in Low-power Mode	V _{IN} = 0V, V _{BAT} = 3.6V, LDO Disabled		0.46	0.9	μA
		V _{IN} = 0V, V _{BAT} = 3.6V, LDO Enabled		1.7	1.9	μA
I _{BAT_ACTIVE}	Battery Quiescent Current in Active Mode	V _{IN} = 0V, V _{BAT} = 3.6V, LDO Disabled		18	23	μA
		V _{IN} = 0V, V _{BAT} = 3.6V, LDO Enabled		21	25	μA
POWER PATH MANAGEMENT AND INPUT CURRENT LIMIT						
V _{PMID_REG}	Default System (PMID) Regulation Voltage			4.5	V	
V _{PMID_REG_ACC}	System Regulation Voltage Accuracy	V _{IN} = 5V, V _{PMID_REG} = 4.5V. I _{PMID} = 100mA, T _J = 25°C		-1	1	%
		V _{IN} = 5V, V _{PMID_REG} = 4.5V. I _{PMID} = 0-500mA		-3	3	%
R _{ON(IN-PMID)}	Input FET ON resistance	I _{LIM} = 500mA (I _{LIM} = 110), V _{IN} = 5V, I _{IN} = 150mA		280	520	mΩ
V _{BSUP1}	Enter supplements mode threshold	V _{BAT} > V _{BATUVLO} , DPPM enabled or Charge disabled		V _{PMID} < V _{BAT} - 40mV		mV
V _{BSUP2}	Exit supplements mode threshold	V _{BAT} > V _{BATUVLO} , DPPM enabled or Charge disabled		V _{PMID} < V _{BAT} - 20mV		mV
I _{LIM}	Input Current Limit	Programmable Range		50	600	mA
		I _{LIM} = 50mA		45	50	mA
		I _{LIM} = 100mA		90	100	mA
		I _{LIM} = 150mA		135	150	mA
		I _{LIM} = 500mA		450	500	mA
V _{IN_DPM}	Input DPM voltage threshold where current in reduced	Programmable Range		4.2	4.9	V
	Accuracy			-3	3	%
BATTERY CHARGER						
V _{DPPM}	PMID voltage threshold when charge current is reduced	V _{PMID} - V _{BAT}		200	mV	
R _{ON(BAT-PMID)}	Battery Discharge FET On Resistance	V _{BAT} = 4.35V, I _{BAT} = 100mA		100	175	mΩ
V _{BATREG}	Charge Voltage	Programmable charge voltage range		3.6	4.6	V
	Voltage Regulation Accuracy			0.5	0.5	%

6.5 Electrical Characteristics (continued)

 $V_{IN} = 5V$, $V_{BAT} = 3.6V$. $T_J = 25^\circ C$ unless otherwise noted.

PARAMETER		TEST CONDITIONS	MIN	TYP	MAX	UNIT
I_{CHARGE}	Fast Charge Programmable Current Range	$V_{LOWV} < V_{BAT} < V_{BATREG}$	1.25		500	mA
	Fast Charge Current Accuracy	$I_{CHARGE} > 5mA$	-5		5	%
$I_{PRECHARGE}$	Precharge current	Precharge current programmable range	1.25		77.5	mA
	Precharge Current Accuracy	$-40^\circ C < T_J < 85^\circ C$	-10		10	%
I_{TERM}	Termination Charge Current	Termination Current Programmable Range	1		31	%
	Accuracy	$I_{TERM} = 10\% I_{CHARGE}$, $I_{CHARGE} = 100mA$	-5 ⁽¹⁾		5 ⁽¹⁾	%
V_{LOWV}	Programmable voltage threshold for pre-charge to fast charge transitions	V_{BAT} rising, Programmable Range	2.8		3	V
V_{SHORT}	Battery voltage threshold for short detection	V_{BAT} falling, $V_{IN} = 5V$	2.41	2.54	2.67	V
I_{SHORT}	Charge Current in Battery Short Condition	$V_{BAT} < V_{SHORT}$		$I_{PRECHARGE}$		mA
V_{RCH}	Recharge Threshold voltage	V_{BAT} falling, $V_{BATREG} = 4.2V$, $V_{RCH} = 140mV$ setting		140		mV
		V_{BAT} falling, $V_{BATREG} = 4.2V$, $V_{RCH} = 200mV$ setting		200		mV
R_{PMID_PD}	PMID pull-down resistance	$V_{PMID} = 3.6V$		25		Ω
VDD						
V_{DD}	VDD LDO output voltage			1.8		V
LS/LDO						
V_{INLS}	Input voltage range for Load switch Mode		0.8		5.5	V
	Input voltage range for LDO Mode		2.2 or $V_{LDO} + 500mV$		5.5	V
V_{LDO}	LDO programmable output voltage range		0.6		3.7	V
	LDO output accuracy	$T_J = 25^\circ C$	-2		2	%
		$V_{LDO} = 1.8V$, $V_{INLS} = 3.6V$, $I_{LOAD} = 1mA$	-3		3	%
$\Delta V_{OUT}/\Delta I_{OUT}$	DC Load Regulation	$0^\circ C < T_J < 85^\circ C$, $1mA < I_{OUT} < 150mA$, $V_{LDO} = 1.8V$		1.2		%
$\Delta V_{OUT}/\Delta V_{IN}$	DC Line Regulation	$0^\circ C < T_J < 85^\circ C$, Over V_{INLS} range, $I_{OUT} = 100mA$, $V_{LDO} = 1.8V$		0.5		%
R_{DOSN_LDO}	Switch On resistance	$V_{INLS} = 3.6V$		250	450	m Ω
R_{DSCH_LDO}	Discharge FET On-resistance for LS	$V_{INLS} = 3.6V$		40		Ω
I_{OCL_LDO}	Output Current Limit	$V_{LS/LDO} = 0V$	200	300		mA
I_{IN_LDO}	LDO VINLS quiescent current in LDO mode	$V_{BAT} = V_{INLS} = 3.6V$		0.9		μA
	OFF State Supply Current	$V_{BAT} = V_{INLS} = 3.6V$		0.25		μA
BATTERY PACK NTC MONITOR						
V_{HOT}	High temperature threshold	V_{TS} falling, $-10^\circ C < T_J < 85^\circ C$	0.182 ⁽¹⁾	0.185	0.189 ⁽¹⁾	V
V_{WARM}	Warm temperature threshold	V_{TS} falling, $-10^\circ C < T_J < 85^\circ C$	0.262 ⁽¹⁾	0.265	0.268 ⁽¹⁾	V
V_{COOL}	Cool temperature threshold	V_{TS} rising, $-10^\circ C < T_J < 85^\circ C$	0.510 ⁽¹⁾	0.514	0.518 ⁽¹⁾	V
V_{COLD}	Cold temperature threshold	V_{TS} rising, $-10^\circ C < T_J < 85^\circ C$	0.581 ⁽¹⁾	0.585	0.589 ⁽¹⁾	V
V_{OPEN}	TS Open threshold	V_{TS} rising, $-10^\circ C < T_J < 85^\circ C$		0.9		V
V_{HYS}	Threshold hysteresis			4.7		mV
I_{TS_BIAS}	TS bias current	$-10^\circ C < T_J < 85^\circ C$	78.4	80	81.6	μA

6.5 Electrical Characteristics (continued)

$V_{IN} = 5V$, $V_{BAT} = 3.6V$. $T_J = 25^\circ C$ unless otherwise noted.

PARAMETER		TEST CONDITIONS	MIN	TYP	MAX	UNIT
PROTECTION						
V_{UVLO}	IN active threshold voltage	V_{IN} rising		3.4		V
		V_{IN} falling		3.25		V
$V_{BATUVLO}$	Battery undervoltage Lockout Threshold Voltage	Programmable range, 150 mV Hysteresis	2.4		3	V
	Accuracy		-3		3	%
	Battery undervoltage Lockout Threshold Voltage at Power Up	V_{BAT} rising, $V_{IN} = 0V$, $T_J = 25^\circ C$		3.15		V
V_{SLP_ENTRY}	Sleep Entry Threshold ($V_{IN} - V_{BAT}$)	$2.0V < V_{BAT} < V_{BATREG}$, V_{IN} falling		80		mV
V_{SLP_EXIT}	Sleep Exit Threshold ($V_{IN} - V_{BAT}$)	$2.0V < V_{BAT} < V_{BATREG}$		130		mV
V_{OVP}	Input Supply Over Voltage Threshold	V_{IN} rising	5.35	5.5	5.8	V
		V_{IN} falling (125mV hysteresis)		5.4		V
I_{BAT_OCP}	Battery Over Current Threshold Programmable range	I_{BAT_OCP} increasing	1200		1600	mA
	Current Limit Accuracy		-30		30	%
$T_{SHUTDOWN}$	Thermal shutdown trip point			125		$^\circ C$
T_{HYS}	Thermal shutdown trip point hysteresis			15		$^\circ C$
I²C INTERFACE (SCL and SDA)						
	I ² C Frequency		100		400	kHz
V_{IL}	Input Low threshold level	$V_{PULLUP} = V_{IO} = 1.8V$			0.25 * V_{IO}	V
V_{IH}	Input High Threshold level	$V_{PULLUP} = V_{IO} = 1.8V$	0.75 * V_{IO}			V
V_{OL}	Output Low threshold level	$V_{PULLUP} = V_{IO} = 1.8V$, $I_{LOAD} = 5mA$			0.25 * V_{IO}	V
I_{LKG}	High-level leakage Current	$V_{PULLUP} = V_{IO} = 1.8V$			1	μA
/MR INPUT						
R_{PU}	Internal pull up resistance		90	125	170	k Ω
V_{IL}	/MR Input Low threshold level	$V_{BAT} > V_{BUVLO}$			0.3	V
/INT, /PG OUTPUTS						
V_{OL}	Output Low threshold level	$V_{PULLUP} = V_{IO} = 1.8V$, $I_{LOAD} = 5mA$			0.25 * V_{IO}	V
I_{LKG}	/INT Hi level leakage Current	High Impedance, $V_{PULLUP} = V_{IO} = 1.8V$			1	μA
/CE, /LP INPUTS						
R_{PDOWN}	/CE pull down resistance			900		k Ω
V_{IL}	Input Low threshold level	$V_{IO} = 1.8V$			0.45	V
V_{IH}	/CE Input High Threshold level	$V_{IO} = 1.8V$	1.35			V

(1) Based on Characterization Data

6.6 Timing Requirements

PARAMETER		TEST CONDITIONS	MIN	TYP	MAX	UNIT
BATTERY CHARGE TIMERS						
t_{MAXCHG}	Charge safety timer	Programmable range	180		720	min
t_{PRECHG}	Precharge safety timer			0.25 * t_{MAXCHG}		
WATCHDOG TIMERS						

6.6 Timing Requirements (continued)

PARAMETER		TEST CONDITIONS	MIN	TYP	MAX	UNIT
$t_{WATCHDOG_SW}$	SW Watchdog timer		25	50		s
$t_{HW_RESET_WD}$	HW reset watchdog timer	HWRESET_14S_WD = 1			14	s
LDO						
t_{ON_LDO}	Turn ON time	100mA load, to 90% V_{LDO}		500		μ s
t_{OFF_LDO}	Turn OFF time	100mA load, to 10% V_{LDO}		30		μ s
$t_{PMID_LDO_DELAY}$	Delay between PMID and LDO enable during power up	Startup		20		ms
PUSHBUTTON TIMERS (/MR)						
t_{WAKE1}	WAKE1 Timer. Timer for Ship Mode wake.	MR_WAKE1_TIMER = 0	106	125	144	ms
t_{WAKE2}	WAKE2 Timer. Time from /MR falling edge to INT being asserted.	MR_WAKE2_TIMER = 1	1.7	2	2.3	s
t_{RESET_WARN}	RESET_WARN Timer. Time prior to HW RESET or entering Shipmode with /MR press	MR_RESET_WARN = 01	0.85	1	1.15	s
t_{HW_RESET}	Time from /MR Falling edge to HW RESET or PMID falling for Shipmode Entry	MR_HW_RESET = 01	6.8	8	9.2	s
$t_{RESTART(AUTOWAKE)}$	RESTART Timer. Time from /MR HW Reset to PMID power up	AUTOWAKE = 01	1.05	1.2	1.35	s
PROTECTION						
t_{DGL_SLP}	Deglitch time for supply rising above $V_{SLP} + V_{SLP_HYS}$			120		μ s
t_{DGL_OVP}	Deglitch time for V_{OVP} Threshold	VIN falling below V_{OVP}		32		ms
t_{DGL_OCP}	Battery OCP deglitch time			30		μ s
t_{REC_SC}	Recovery time, BAT Short Circuit during Discharge Mode			250		ms
t_{RETRY_SC}	Retry window for PMID or BAT short circuit recovery			2		s
t_{DGL_SHTDWN}	Deglitch time, Thermal shutdown	T_J rising above $T_{SHUTDOWN}$		10		μ s
I2C INTERFACE						
$t_{WATCHDOG_I2C}$	I2C interface reset timer for host	When enabled		50		s
t_{I2C_RESET}	I2C interface inactive reset timer			500		ms
INPUT PINS (/CE and /LP)						
$t_{LP_EXIT_I2C}$	Time for device to exit Low-power mode and allow I2C communication	$V_{IN} = 0V$.			1	ms

6.7 Typical Characteristics

$C_{IN} = 1 \mu F$, $C_{PMID} = 10 \mu F$, $C_{LSLDO} = 2.2 \mu F$, $C_{BAT} = 1 \mu F$ (unless otherwise specified)

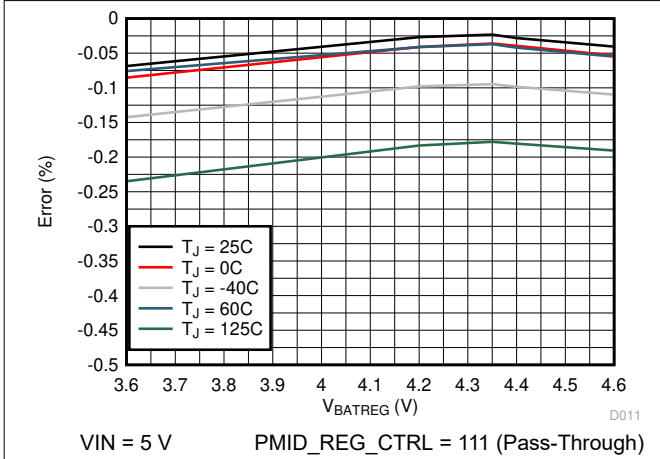

Figure 6-1. Battery Regulation Voltage Accuracy vs. VBATREG Setting

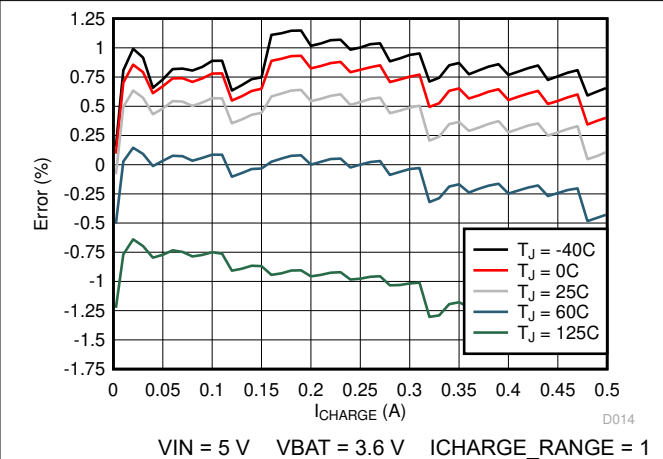

Figure 6-2. Charge Current Accuracy vs. ICHARGE Setting

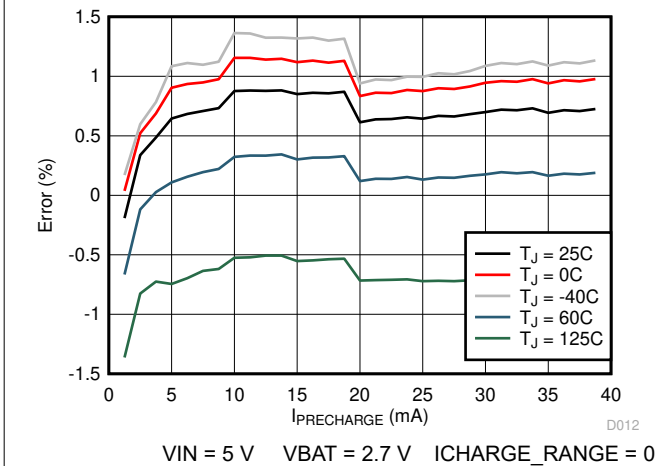

Figure 6-3. Pre-Charge Current Accuracy vs. IPRECHARGE setting (ICHARGE_RANGE = 0)

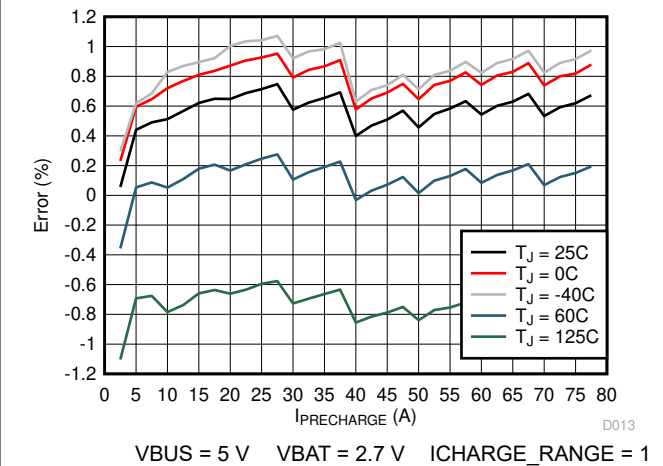

Figure 6-4. Pre-Charge Current Accuracy vs. IPRECHARGE Setting (ICHARGE_RANGE = 1)

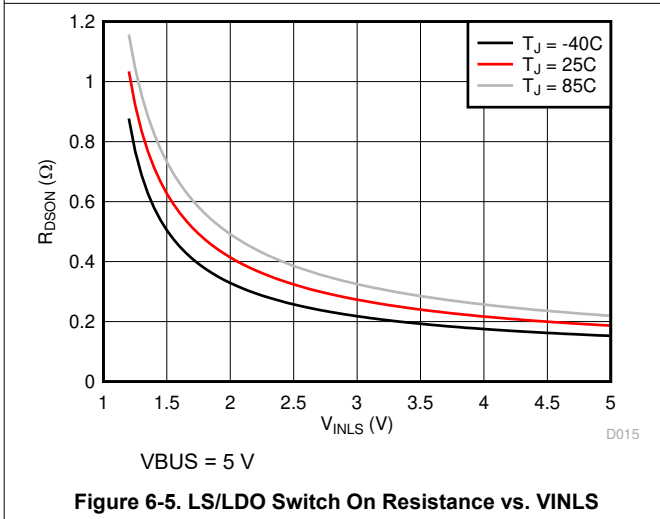

Figure 6-5. LS/LDO Switch On Resistance vs. VINLS

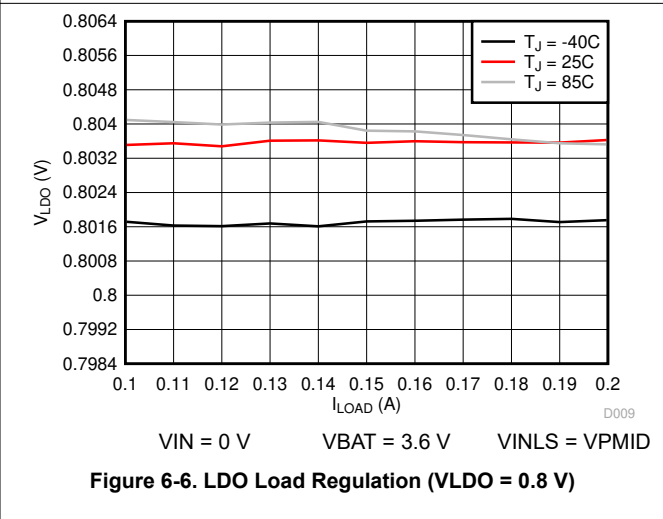

Figure 6-6. LDO Load Regulation (VLDO = 0.8 V)

6.7 Typical Characteristics (continued)

$C_{IN} = 1 \mu\text{F}$, $C_{PMID} = 10 \mu\text{F}$, $C_{LSLDO} = 2.2 \mu\text{F}$, $C_{BAT} = 1 \mu\text{F}$ (unless otherwise specified)

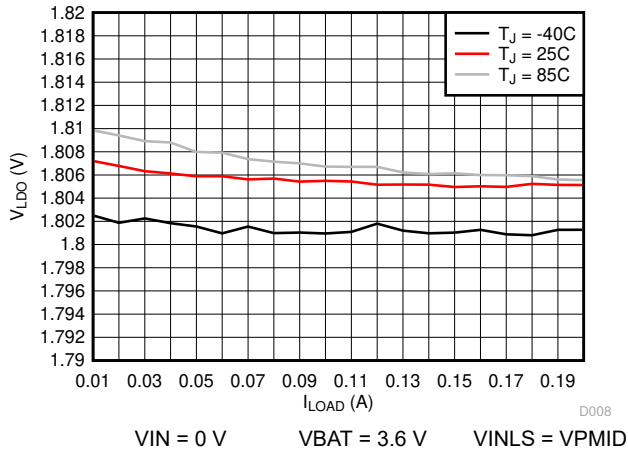

Figure 6-7. LDO Load Regulation (VLDO = 1.8 V)

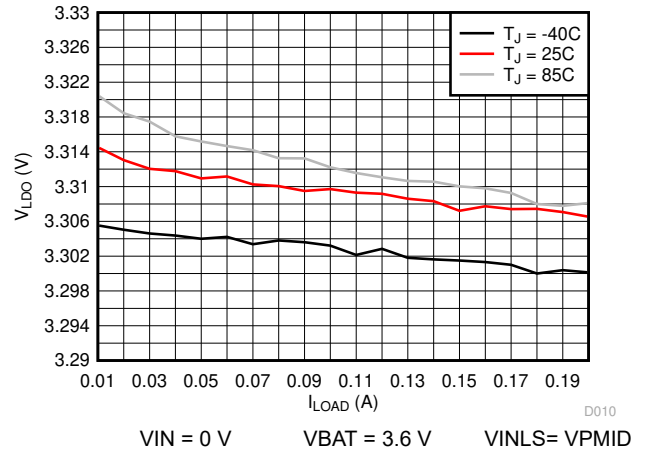

Figure 6-8. LDO Load Regulation (VLDO = 3.3 V)

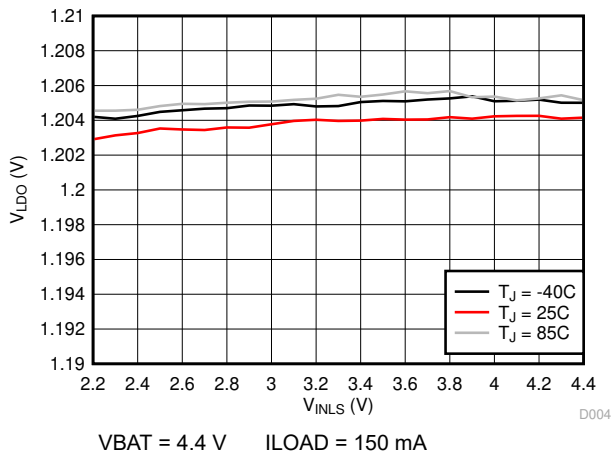

Figure 6-9. LDO Line Regulation (VLDO = 1.2 V)

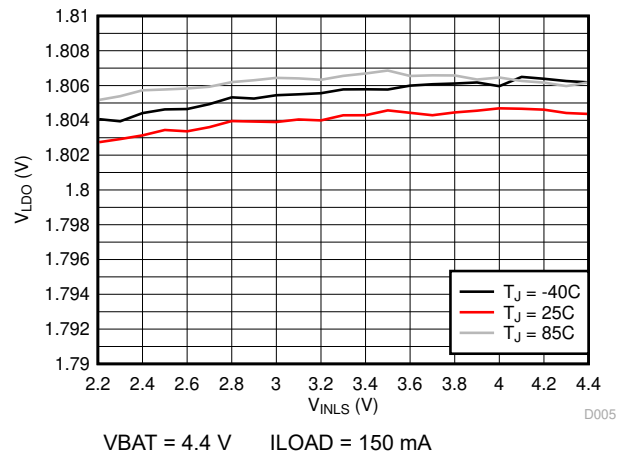

Figure 6-10. LDO Line Regulation (VLDO = 1.8 V)

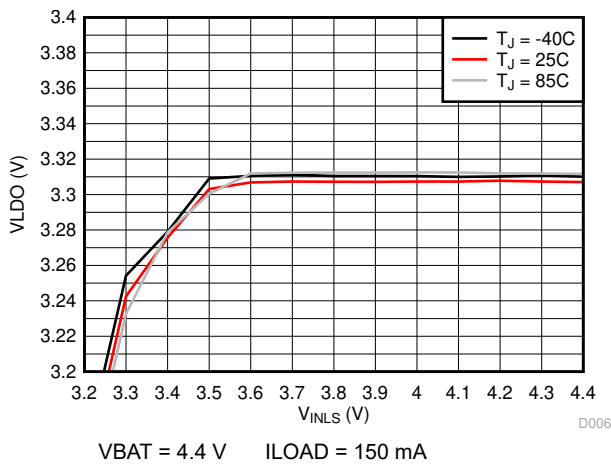

Figure 6-11. LDO Line Regulation (VLDO = 3.3 V)

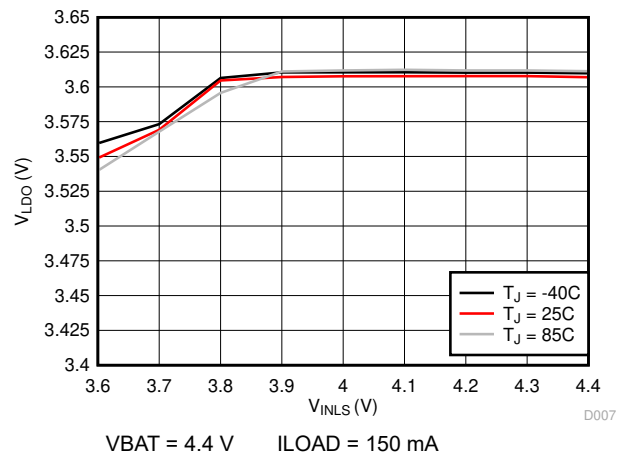

Figure 6-12. LDO Line Regulation (VLDO = 3.6 V)

6.7 Typical Characteristics (continued)

$C_{IN} = 1 \mu F$, $C_{PMID} = 10 \mu F$, $C_{LSLDO} = 2.2 \mu F$, $C_{BAT} = 1 \mu F$ (unless otherwise specified)

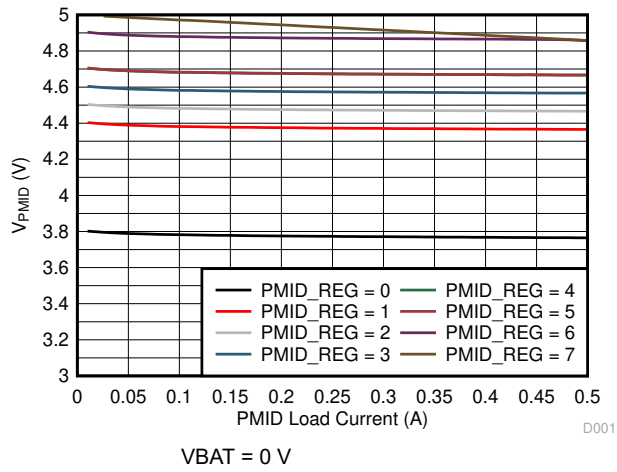

Figure 6-13. PMID Load Regulation

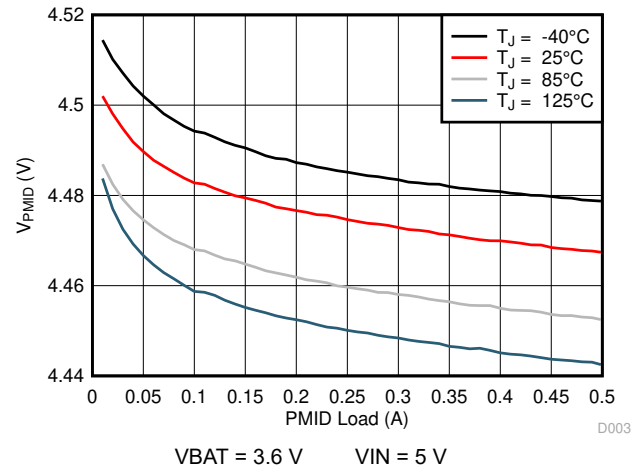

Figure 6-14. PMID Load Regulation vs. Temperature

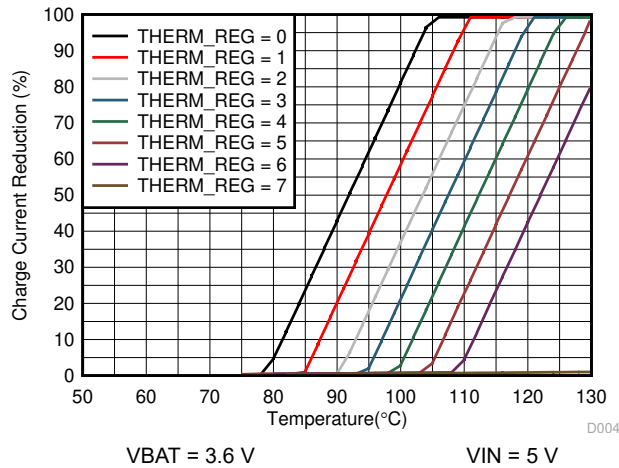

Figure 6-15. Charge Current Thermal Regulation

7 Detailed Description

7.1 Overview

The BQ21061 IC is a highly programmable battery management device that integrates a 500-mA linear charger for single cell Li-Ion batteries, a general purpose LDO that may be configured as a load switch, and a push-button controller. Through its I²C interface the host may change charging parameters such as battery regulation voltage and charge current, and obtain detailed device status and fault information. The push-button controller allows the user to reset the system without any intervention from the host and wake up the device from Ship Mode.

7.2 Functional Block Diagram

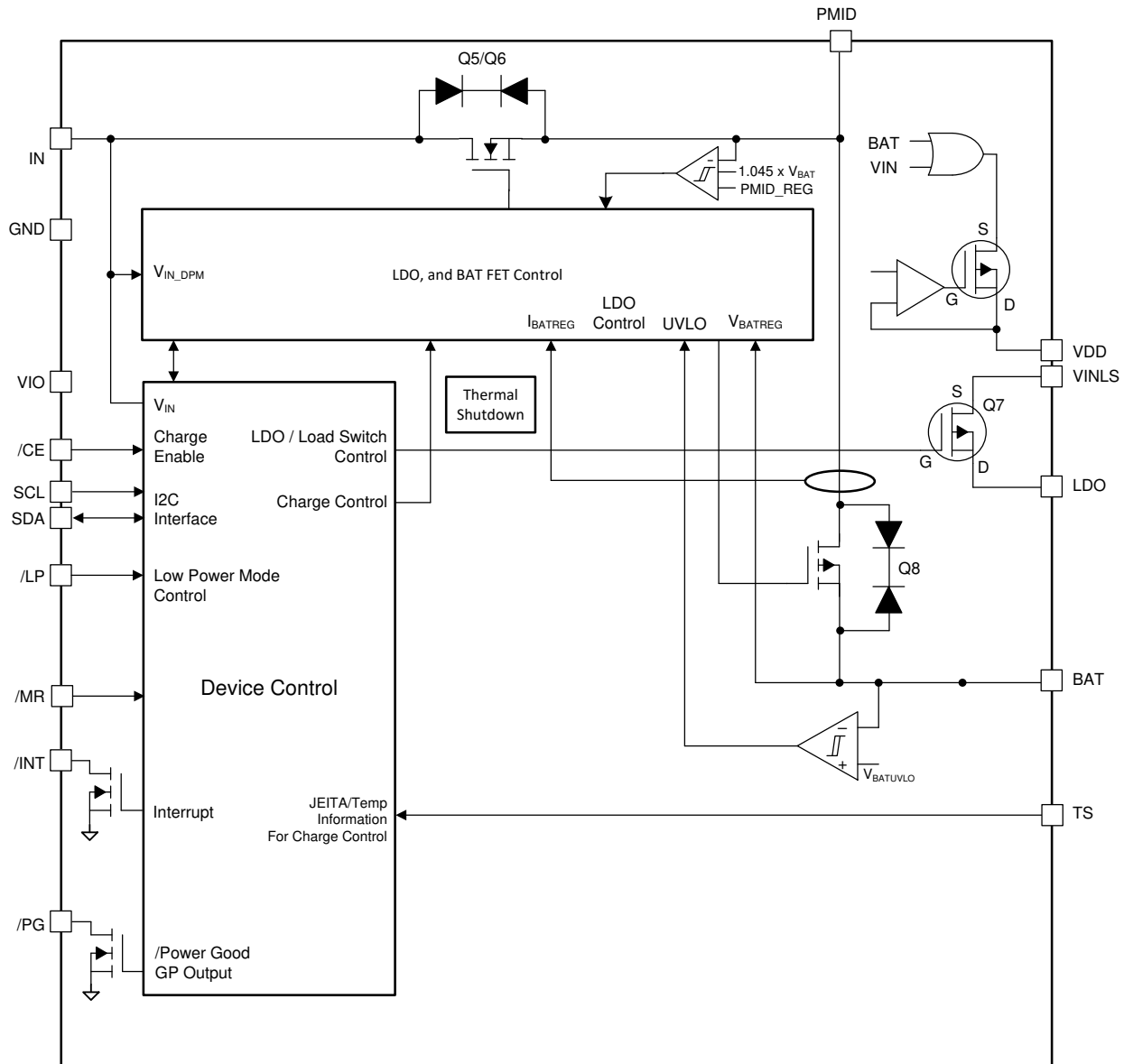

7.3 Feature Description

7.3.1 Linear Charger and Power Path

The BQ21061 IC integrates a linear charger that allows the battery to be charged with a programmable charge current of up to 500 mA. In addition to the charge current, other charging parameters can be programmed

through I²C such as the battery regulation voltage, pre-charge current, termination current, and input current limit current.

The power path allows the system to be powered from PMID, even when the battery is dead or charging, by drawing power from IN pin. It also prioritizes the system load connected to PMID, reducing the charging current, if necessary, in order to support the load when input power is limited. If the input supply is removed and the battery voltage level is above V_{BATUVLO}, PMID will automatically and seamlessly switch to battery power.

A more detailed description of the charger functionality is presented in the following sections of this document.

7.3.1.1 Battery Charging Process

The following diagram summarizes the charging process of the BQ21061 charger.

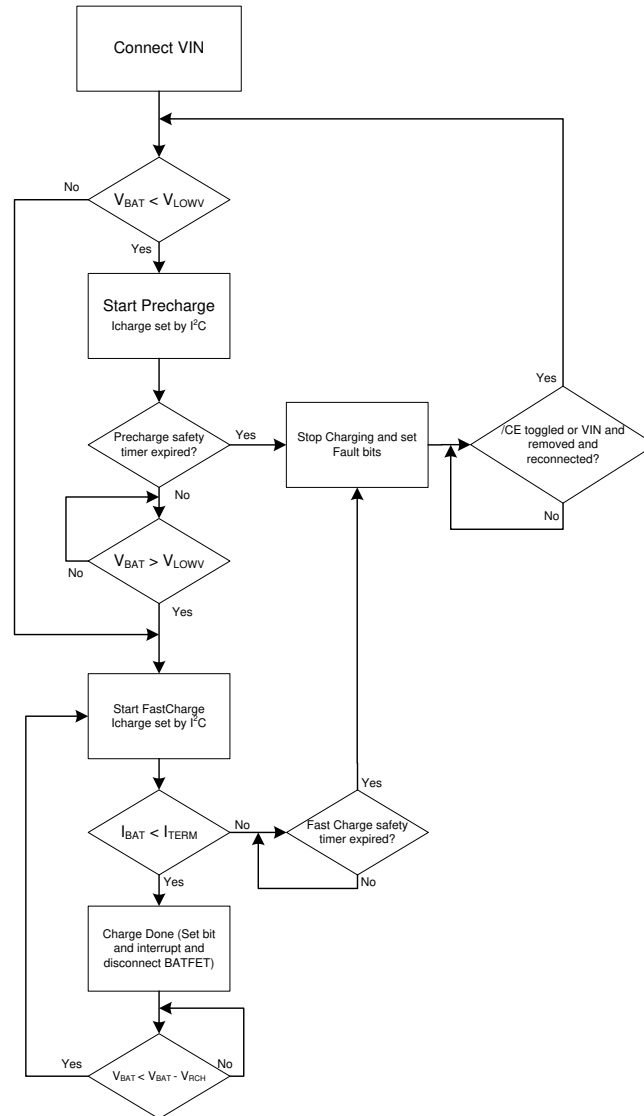

Figure 7-1. BQ21061 Charger Flow Diagram

When a valid input source is connected ($V_{IN} > V_{UVLO}$ and $V_{BAT} + V_{SLP} < V_{IN} < V_{OVP}$), the state of the \overline{CE} pin determines whether a charge cycle is initiated. When the \overline{CE} input is high and a valid input source is connected, the battery charge FET is turned off, preventing any kind of charging of the battery. A charge cycle is initiated when the CHARGE_DISABLE bit is written to 0 and \overline{CE} pin in low. Table 7-1 shows the \overline{CE} pin and bit priority to enable/disable charging.

Table 7-1. Charge Enable Function Through \overline{CE} Pin and \overline{CE} Bit

CE PIN	CHARGE_DISABLE BIT	CHARGING
0	0	Enabled
0	1	Disabled
1	0	Disabled
1	1	Disabled

Figure 7-2 shows a typical charge cycle.

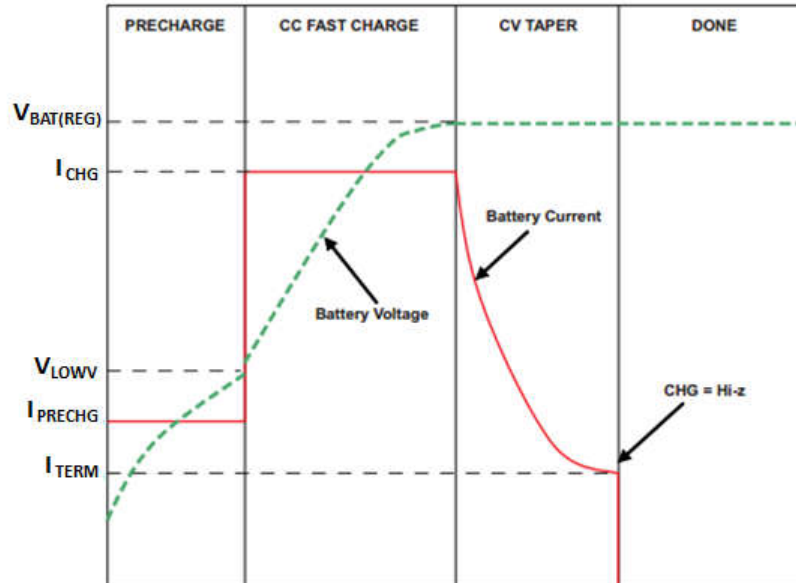

Figure 7-2. BQ21061 Typical Charge Cycle

During Pre-Charge, where the battery voltage is below the V_{LOWV} level, the battery will be charge with $I_{PRECHARGE}$ current which can be programmed through I²C. During pre-charge, the safety timer is set to 25% of the safety timer value during fast charge. Once the battery voltage reaches V_{LOWV} , the charger will then operate in Fast Charge Mode, charging the battery at I_{CHARGE} which may also be programmed through I²C. Once the battery voltage approaches the V_{BATREG} level, the charging current starts tapering off as shown in Figure 7-2. Once the charging current reaches the termination current (I_{TERM}) charging is stopped. Note that to ensure that the battery is charged to V_{BATREG} level, the regulated PMID voltage should be set to at least 200mV above V_{BATREG} . Termination is only enabled when the charger CV loop is active in fast charge operation. No termination will occur if the charge current reaches I_{TERM} while $VINDPM$ or $DPPM$ is active as well as the thermal regulation loop. Termination is also disabled when operating in the TS WARM region. The charger only goes to termination when the current drops to I_{TERM} due to the battery reaching the target voltage and not due to the charge current limitation imposed by the previously mentioned control loops

Whenever a change in the charge current setting is triggered, whether it occurs due to I²C programming by the host, Pre-Charge/Fast Charge transition or JEITA TS control, the device will temporarily disable charging (for ~ 1 ms) before updating the charge current value.

7.3.1.2 JEITA and Battery Temperature Dependent Charging

The charger can be configured through I²C setting to provide JEITA support, automatically reducing the charging current and voltage depending on the battery temperature as monitored by an NTC thermistor connected to the BQ21061 TS pin. See Section 7.3.11 for details.

7.3.1.3 Input Voltage Based Dynamic Power Management (VINDPM) and Dynamic Power Path Management (DPPM)

The VINDPM loop prevents the input voltage from collapsing to a point where charging would be interrupted by reducing the current drawn by charger in order to keep V_{IN} from dropping below V_{IN_DPM} . Once the IN voltage drops to V_{IN_DPM} , the VINDPM loops will reduce the input current through the blocking FETs, to prevent the further drop of the supply voltage. The VINDPM function is disabled by default and may be enabled through I²C command. The V_{IN_DPM} threshold is programmable through the I²C register from 4.2 V to 4.9 V in 100-mV steps.

On the other hand, the DPPM loop prevents the system output (PMID) from dropping below $V_{BAT} + 200\text{mV}$ when the sum of the charge current and system load exceeds the BQ21061 input current limit setting. If PMID drops below the DPPM voltage threshold, the charging current is reduced. If PMID continues to drop after BATFET charging current is reduced to zero, the part will enter supplement mode when PMID falls below the supplement mode threshold ($V_{BAT} - V_{BSUP1}$). Note that DPPM function is disabled when PMID regulation is set to battery tracking.

When the device enters these modes, the charge current may be lower than the set value and the corresponding status bits and flags are set. If the 2X timer is set, the safety timer is extended while the loops are active. Additionally, termination is disabled.

7.3.1.4 Battery Supplement Mode

When the PMID voltage drops below the battery voltage by V_{BSUP1} , the battery supplements the system load. The battery stops supplementing the system load when the voltage on the PMID pin rises above the battery voltage by V_{BSUP2} . During supplement mode, the battery supplement current is not regulated, however, the Battery Over-Current Protection mechanism is active. Battery charge termination is disabled while in supplement mode.

7.3.2 Protection Mechanisms

7.3.2.1 Input Over-Voltage Protection

The input over-voltage protection protects the device and downstream components connected to PMID, and BAT against damage from over-voltage on the input supply. When $V_{IN} > V_{OVP}$ an OVP fault is determined to exist. During the OVP fault, the device turns the input FET off, sends a single 128- μs pulse on $\overline{\text{INT}}$, and the $V_{IN_OVP_FAULT}$ FLAG and STAT bits are updated over I²C. Once the OVP fault is removed, the STAT bit is cleared and the device returns to normal operation. The FLAG bit is not cleared until it is read through I²C after the OVP condition no longer exists. The OVP threshold for the device is 5.5 V to allow operation from standard USB sources.

7.3.2.2 Safety Timer and I²C Watchdog Timer

At the beginning of the charge cycle, the device starts the safety timer. If charging has not terminated before the programmed safety time, t_{MAXCHG} , expires, charging is disabled. The pre-charge safety time, t_{PRECHG} , is 25% of t_{MAXCHG} . When a safety timer fault occurs, a single 128- μs pulse is sent on the $\overline{\text{INT}}$ pin and the SAFETY_TMR_FAULT_FLAG bit in the FLAG3 register is updated over I²C. The $\overline{\text{CE}}$ pin or input power must be toggled in order to reset the safety timer and exit the fault condition. Note that the flag bit will be reset when the bit is read by the host even if the fault has not been cleared. The safety timer duration is programmable using the SAFETY_TIMER bits. When the safety timer is active, changing the safety timer duration resets the safety timer. The device also contains a 2X_TIMER bit that doubles the timer duration to prevent premature safety timer expiration when the charge current is reduced by a high load on PMID (DPPM operation), VIN DPM, thermal regulation, or a NTC (JEITA) condition. When 2X_TIMER function is enabled, the timer is allowed to run at half speed when any loop is active other than CC or CV.

In addition, the BQ21061 has a 50s watchdog timer which resets after every I²C transaction. This feature, which is enabled by default, resets all charger parameters registers to their default values when the timer expires.

7.3.2.3 Thermal Protection and Thermal Charge Current Foldback

In order to protect the device from damage due to overheating, the junction temperature of the die, T_J , is monitored. When T_J reaches T_{SHUTDOWN} the device stops operation and is turned off. The device resumes operation when T_J falls below T_{SHUTDOWN} by T_{HYS} .

During the charging process, the device will reduce the charging current at a rate of $(0.04 \times I_{\text{CHARGE}})^\circ\text{C}$ once T_J exceeds the thermal foldback threshold, T_{REG} to prevent further heating. If the charge current is reduced to 0, the battery supplies the current needed to supply the PMID output. The thermal regulation threshold may be set through I²C by setting the THERM_REG bits to the desired value.

The die junction temperature, T_J , can be estimated based on the expected board performance using [Equation 1](#):

$$T_J = T_A + \theta_{JA} \times P_{\text{DISS}} \tag{1}$$

Where P_{DISS} is the total power dissipation in the IC. The θ_{JA} is largely driven by the board layout. For more information about traditional and new thermal metrics, see the [Semiconductor and IC Package Thermal Metrics Application Report](#). Under typical conditions, the time spent in this state is very short.

7.3.2.4 Battery Short and Over Current Protection

In order to protect the device from over current and prevent excessive battery discharge current, the BQ21061 detects if the current on the battery FET exceeds $I_{\text{BAT_OCP}}$. If the short circuit limit is reached for the deglitch time ($t_{\text{DGL_OCP}}$), the battery discharge FET is turned off and start operating in hiccup mode, re-enabling the BATFET $t_{\text{REC_SC}}$ (250 ms) after being turned off by the over-current condition. If the over-current condition is triggered upon retry for 3 to 7 consecutive times, the BATFET will then remain off until the part is reset or until V_{IN} is connected and valid. If the over-current condition and hiccup operation occurs while in supplement mode where V_{IN} is already present, V_{IN} must be toggled in order for BATFET to be enabled and start another detection cycle.

In the case where the battery is suddenly shorted while charging and V_{BAT} drops below V_{SHORT} , a fast comparator quickly reduces the charge current to $I_{\text{PRECHARGE}}$ preventing fast charge current to be momentarily injected to the battery while shorted.

7.3.2.5 PMID Short Circuit

A short on the PMID pin is detected when the PMID voltage drops below 1.6 V (PMID short threshold). PMID short threshold has a 200-mV hysteresis. When this occurs, the input FET temporarily disconnects I_{N} for up to 200 μs to prevent stress on the device if a sudden short condition happens, before allowing a softstart on the PMID output.

7.3.3 VDD LDO

The device integrates a low current always-on LDO that serves as the digital I/O supply to the device. This LDO is supplied by V_{IN} or by BAT . The VDD LDO will remain on through all power states with the exception of Ship Mode.

7.3.4 Load Switch/LDO Output and Control

The device integrates a low I_q load switch which can also be used as a regulated output. The LDO/LS has a dedicated input pin V_{INLS} and can support up to 150 mA of load current.

The LS/LDO may be enabled/disabled through I²C. The output voltage is programmable using the LS_LDO bits in the registers. To limit voltage drop or voltage transients, a small ceramic capacitor must be placed close to V_{INLS} pin.

Table 7-2. LDO Mode Control

I2C EN_LS_LDO	LS_CONFIG	LS/LDO OUTPUT
0	0	Pulldown
0	1	Pulldown
1	0	LDO
1	1	Load Switch

The current capability of the LDO will depend on the V_{INLS} input voltage and the programmed output voltage. When the LS/LDO output is disabled through the register, an internal pull-down will discharge the output. The

LDO has output current limit protection, limiting the output current in the event of a short in the output. When the LDO output current limit trips and is active for at least 1 ms, the device will set a flag and send an interrupt to the host. The host must take action to disable the LDO if desired. The LDO may be set to operate as a load switch by setting the LS_SWITCH_CONFIG bit. Note that in order to change the configuration the LDO must be disabled first, then the LS_SWITCH_CONFIG bit is set for it to take effect. This is not the case when updating the LDO output voltage which can be done on the fly without the need of disabling the LDO first.

7.3.5 PMID Power Control

The BQ21061 offers the option to control PMID through the I²C PMID_MODE bits. These bits can force PMID to be supplied by BAT instead of IN, even if $V_{IN} > V_{BAT} + V_{SLP}$. They can also disconnect PMID, pulling it down or leaving it floating. See [Table 7-30](#) for details.

7.3.6 System Voltage (PMID) Regulation

The BQ21061 has a regulated system voltage output (PMID) that is programmable through I²C. PMID regulation is only active when the adapter is connected and $V_{IN} > V_{UVLO}$, $V_{IN} > V_{BAT} - V_{SLP}$ and $V_{IN} < V_{OVP}$. In Battery Tracking operation (PMID_REG_CTRL = 000), the PMID voltage will be regulated to about 4.7% over battery level ($V_{PMID} = V_{BAT} \times 1.047$) or 3.8 V, whichever is higher. Note that the PMID regulation target should be set to be at least 200mV higher than V_{BATREG} .

7.3.7 MR Wake and Reset Input

The \overline{MR} input has three main functions in the BQ21061. First, it serves as a means to wake the device from Ship Mode. Second, it serves as a short button press detector, sending an interrupt to the host when the button driving the \overline{MR} pin has been pressed for a given period of time. This allows the implementation of different functions in the end application such as menu selection and control. And finally it serves as a means to get the BQ21061 to reset the system by performing a power cycle (shut down PMID and automatically powering it back on) or go to Ship Mode after detecting a long button press. The timing for the short and long button press duration is programmable through I²C for added flexibility. Note that if a specific timer duration is changed through I²C while that timer is active and has not expired, the new programmed value will be ignored until the timer expires and/or is reset by \overline{MR} . The \overline{MR} input has an internal pull-up to BAT.

7.3.7.1 \overline{MR} Wake or Short Button Press Functions

There are two programmable wake or short button press timers, WAKE1 and WAKE2. When the \overline{MR} pin is held low for t_{WAKE1} the device sends an interrupt (128 μ s active low pulse in the INT pin) and sets the MRWAKE1_TIMEOUT flag when it expires. If the \overline{MR} pin continues to be driven low after WAKE1 and the WAKE2 timer expires, the BQ21061 sends a second interrupt and sets the MRWAKE2_TIMEOUT flag. WAKE1 is used as the timer to wake the device from ship mode. WAKE2's only function is to send the interrupt and has no effect on other BQ21061 functions. These flags are not cleared until they have been read by the host. Note that interrupts are only sent when the flags are set and the flags must be cleared in order for another interrupt to be sent upon \overline{MR} press. The timer durations can be set through the MR_WAKE_x_TIMER bits in the [MRCTRL Register](#) section.

One of the main \overline{MR} functions is to wake the device from Ship Mode when the \overline{MR} is asserted. The device will exit the Ship Mode when the \overline{MR} pin is held low for at least t_{WAKE1} . Immediately after the \overline{MR} is asserted, VDD will be enabled and the digital will start the WAKE counter. If the \overline{MR} signal remains low until after the WAKE1 timer expires, the device will power up PMID and LDO (if enabled) completing the exit from the ship mode. If the \overline{MR} signal goes high before the WAKE1 timer expires, the device will go back to the Ship Mode operation, never powering up PMID or the LDO. Note that if the \overline{MR} pin remains low after exiting Ship Mode the wake interrupts will not be sent and the long button press functions like HW reset will not occur until the \overline{MR} pin is toggled. In the case where a valid V_{IN} ($V_{IN} > V_{UVLO}$) is connected prior to WAKE2 timer expiring, the device will exit the ship mode immediately regardless of the \overline{MR} or wake timer state. [Figure 7-3](#) and [Figure 7-4](#) show these different scenarios.

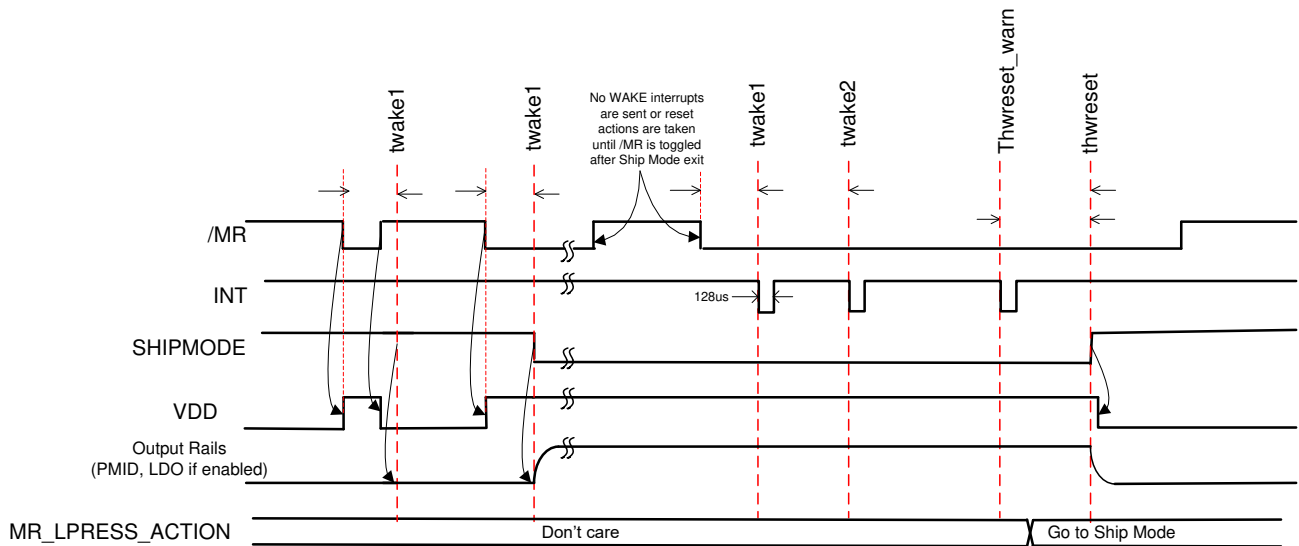

Figure 7-3. MR Wake from Ship Mode (MR_LPRESS_ACTION = Ship Mode, VIN not valid)

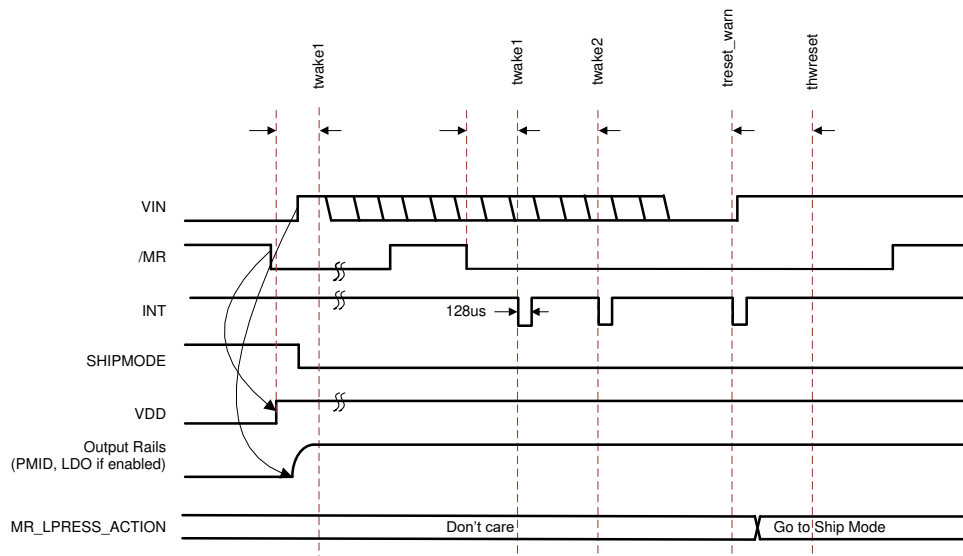

Figure 7-4. MR Wake from Ship Mode – VIN Dependencies

7.3.7.2 \overline{MR} Reset or Long Button Press Functions

The BQ21061 device may be configured to perform a system hardware reset (Power Cycle/Autowake), go into Ship Mode, or simply do nothing after a long button press (for example, when the \overline{MR} pin is driven low until the MR_HW_RESET timer expires). The action taken by the device when the timer expires is configured through the MR_LPRESS_ACTION bits in the ICCTRL1 Register section. Once the MR_HW_RESET timer expires the device immediately performs the operation set by the MR_LPRESS_ACTION bits. The BQ21061 sends an interrupt to the host when the device detects that \overline{MR} has been pressed for a period that is within $t_{HW_RESET_WARN}$ from reaching t_{HW_RESET} . This may warn the host that the button has been pressed for a period close to t_{HW_RESET} which would trigger a HW Reset or used as another button press timer interrupt like the WAKE1 and WAKE2 timers. This interrupt is sent before the MR_HW_RESET timer expires and sets the MRRESET_WARN flag. The t_{RESET_WARN} may be set through I²C by the MR_RESET_WARN bits in the MRCTRL register. The host may change the reset behavior at any time after \overline{MR} going low and prior to the MR_HW_RESET timer expiring. It may not change it however from another behavior to a HW reset (Power Cycle/Autowake) since a HW reset can be gated by other condition requirements, such as valid VIN presence

(controlled by MR_RESET_VIN bit), throughout the whole duration of the button press. This flexibility allows the host to abort any reset or power shutdown to the system by overriding a long button press command.

A HW reset may also be started by setting the HW_RESET bit. Note that during a HW reset, VDD remains on.

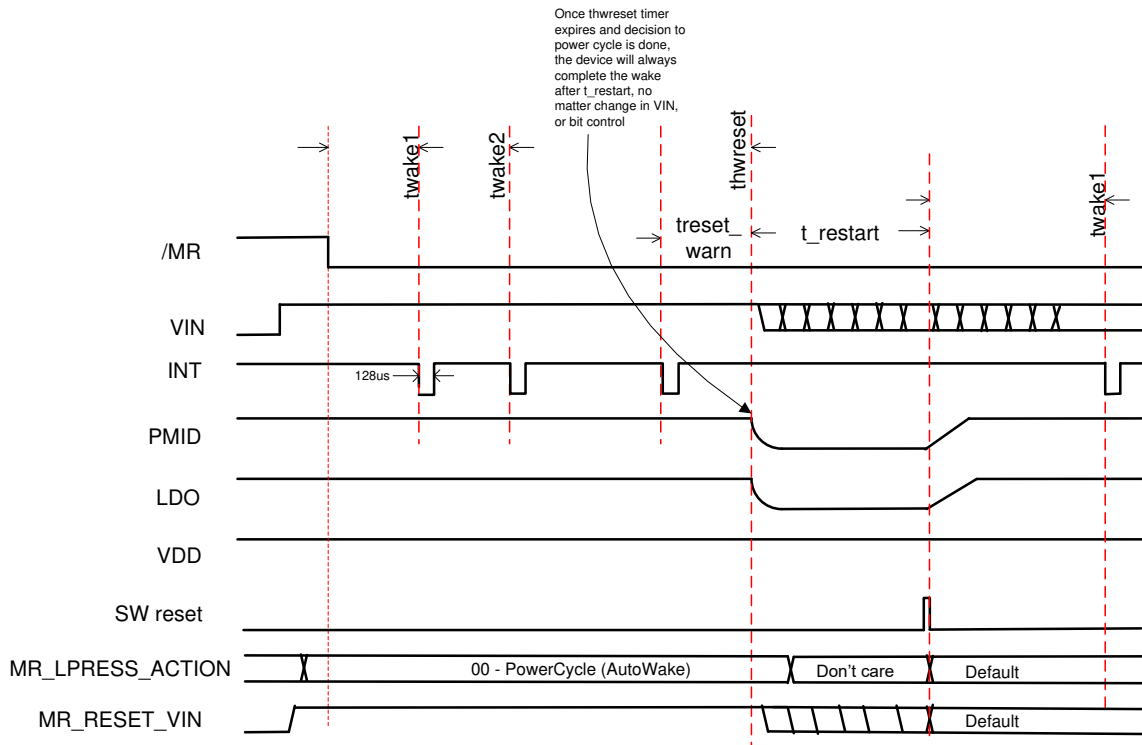

Figure 7-5. MR Wake and Reset Timing with VIN Present or BAT Active Mode When MR_LPRESS_ACTION = 00

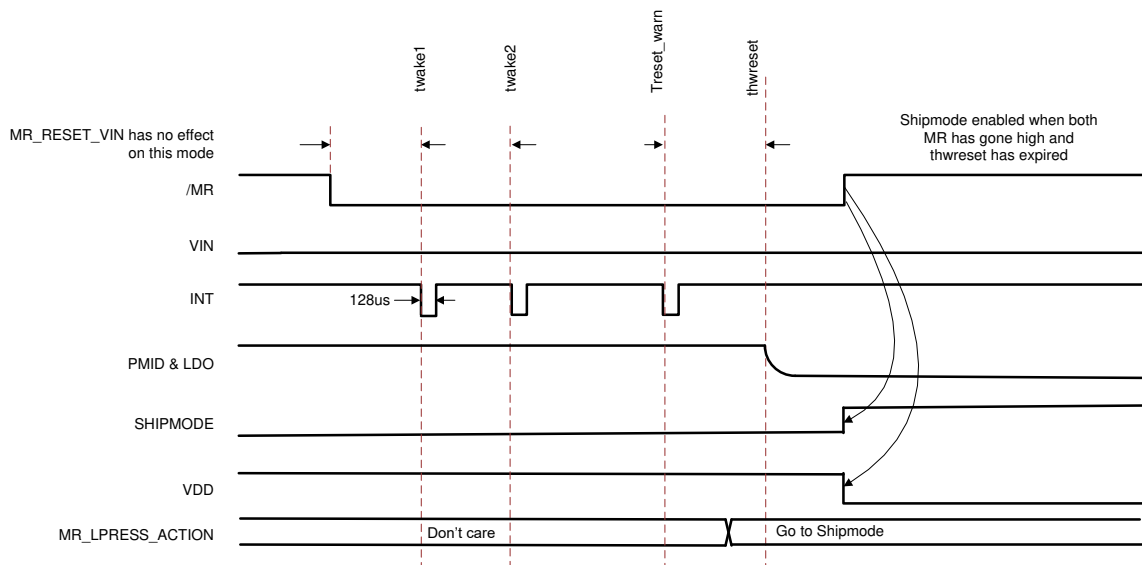

Figure 7-6. MR Wake and Reset Timing Active Mode When MR_LPRESS_ACTION = 1x (Ship Mode) and Only BAT is Present

7.3.8 14-Second Watchdog for HW Reset

The BQ21061 integrates a 14-second watchdog timer that makes the BQ21061 perform a HW reset/power cycle if no I²C transaction is detected within 14 seconds of a valid adapter being connected. If the adapter is

connected and the host responds with an I²C transaction before the 14-second watchdog window expires, the part continues in normal operation. The 14-second watchdog is disabled by default and may be enabled through I²C by setting the HWRESET_14S_WD bit. **Figure 7-7** shows the basic functionality of this feature.

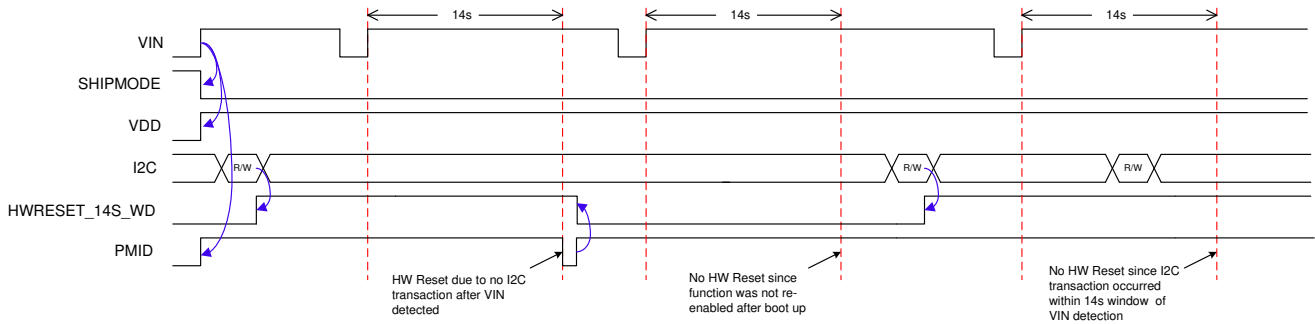

Figure 7-7. 14-Second Watchdog for HW Reset Behavior

7.3.9 Faults Conditions and Interrupts (INT)

The device contains an open-drain output that signals an interrupt and is valid only after the device has completed start-up into a valid state. If the part starts into a fault, interrupts will not be sent. The INT pin is normally in high impedance and is pulled low for 128 μs when an interrupt condition occurs. When a fault or status change occurs or any other condition that generates an interrupt such as CHARGE_DONE, a 128-μs pulse (interrupt) is sent on INT to notify the host. All interrupts may be masked through I²C. If the interrupt condition occurs while the interrupt is masked an interrupt pulse will not be sent. If the interrupt is unmasked while the fault condition is still present, an interrupt pulse will not be sent until the INT trigger condition occurs while unmasked.

7.3.9.1 Flags and Fault Condition Response

Table 7-3 below details the BQ21061 behavior when a fault condition occurs.

Table 7-3. Interrupt Triggers and Fault Condition Response

FAULT / FLAG	DESCRIPTION	INTERRUPT TRIGGER BASED ON STATUS BIT CHANGE	CHARGER BEHAVIOR	CHARGER SAFETY TIMER	PMID BEHAVIOR
CHRG_CV_FLAG	Set when charger enters Constant Voltage operation	Rising Edge	Enabled	No effect	IN powered if V _{IN} is valid
CHARGE_DONE_FLAG	Set when charger reaches termination	Rising Edge	Paused- Charging resumes with VIN or CE toggle or when V _{RCH} is reached	Reset	IN powered if V _{IN} is valid
IINLIM_ACTIVE_FLAG	Set when Input Current Limit loop is active	Rising Edge	Enabled. Reduced charge current.	Doubled if option is enabled	IN powered VIN powered unless supplement mode condition is met.
VDPPM_ACTIVE_FLAG	Set when DPPM loop is active	Rising Edge	Enabled. Reduced charge current.	Doubled if option is enabled	VIN powered unless supplement mode condition is met.
VINDPM_ACTIVE_FLAG	Set when VINDPM loop is active	Rising Edge	Enabled. Reduced charge current.	Doubled if option is enabled	VIN powered unless supplement mode condition is met.
THERMREG_ACTIVE	Set when Thermal Charge Current Foldback (Thermal Regulation) loop is active	Rising Edge	Enabled. Reduced charge current.	Doubled if option is enabled	VIN powered unless supplement mode condition is met.

Table 7-3. Interrupt Triggers and Fault Condition Response (continued)

FAULT / FLAG	DESCRIPTION	INTERRUPT TRIGGER BASED ON STATUS BIT CHANGE	CHARGER BEHAVIOR	CHARGER SAFETY TIMER	PMID BEHAVIOR
VIN_PGOOD_FLAG	Set when VIN changes PGOOD status	Rising and Falling Edge	If VIN_PGOOD_STAT is low, charging is disabled.	Reset	VIN powered (if VIN_PGOOD_STAT =1) unless PMID_MODE is not 00.
VIN_OVP_FAULT_FLAG	Set when $V_{IN} > V_{OVP}$	Rising Edge	Charging is paused until condition disappears	Reset	BAT powered
BAT_OCP_FAULT_FLAG	Set when $I_{BAT} > I_{BATOC}$	Rising Edge	Disabled (BAT only condition)	N/A	Disconnect BAT
BAT_UVLO_FAULT_FLAG	Set when $V_{BAT} < V_{BATUVLO}$	Rising Edge	Enabled	No effect	IN powered if V_{IN} is valid
TS_COLD_FLAG	Set when $V_{TS} > V_{TS_COLD}$	Rising Edge	Charging paused until condition is cleared	Paused	IN powered if V_{IN} is valid
TS_COOL_FLAG	Set when $V_{TS_COLD} > V_{TS} > V_{TS_COOL}$	Rising Edge	Enabled. Reduced charge current.	Doubled if option is enabled	IN powered if V_{IN} is valid
TS_WARM_FLAG	Set when $V_{TS_HOT} < V_{TS} < V_{TS_WARM}$	Rising Edge	Enabled. Reduce battery regulation voltage.	No effect	IN powered if V_{IN} is valid
TS_HOT_FLAG	Set when $V_{TS} < V_{HOT}$	Rising Edge	Charging paused until condition is cleared	Paused	IN powered if V_{IN} is valid
TS_OPEN_FLAG	Set when $V_{TS} > V_{TS_OPEN}$	Rising Edge	Charging is paused until condition disappears	Paused	N/A
WD_FAULT_FLAG	Set when I ² C watchdog timer expires	Rising Edge	Enabled	N/A	N/A
SAFETY_TMR_FAULT_FLAG	Set when safety Timer expires. Cleared after VIN or \overline{CE} toggle	Rising Edge	Disabled until VIN or \overline{CE} toggle	Reset after flag is cleared	IN powered if V_{IN} is valid
LS_LDO_OCP_FAULT_FLAG	Set when LDO output current exceeds OCP condition	Rising Edge	N/A	N/A	N/A
MRWAKE1_TIMEOUT_FLAG	Set when \overline{MR} is low for at least t_{WAKE1}	Rising Edge	N/A	N/A	N/A
MRWAKE2_TIMEOUT_FLAG	Set when \overline{MR} is low for at least t_{WAKE2}	Rising Edge	N/A	N/A	N/A
MRRESET_WARN_FLAG	Set when \overline{MR} is low for at least $t_{RESETWARN}$	Rising Edge	N/A	N/A	N/A
TSHUT	No flag. Die temperature exceeds thermal shutdown threshold is reached	N/A	Disabled	Disabled	Disabled

7.3.10 Power Good (\overline{PG}) Pin

The \overline{PG} pin is an open-drain output that by default indicates when a valid IN supply is present. It may also be configured to be a general purpose output (GPO) controlled through I²C or to be a level shifted version of the \overline{MR} input signal. Connect \overline{PG} to the desired logic voltage rail using a 1-k Ω to 100-k Ω resistor, or use with an LED for visual indication. See [Table 7-30](#) for details.

7.3.11 External NTC Monitoring (TS)

The I²C interface allows the user to easily implement the JEITA standard for systems where the battery pack thermistor is monitored by the host. Additionally, the device provides a flexible voltage based TS input for

monitoring the battery pack NTC thermistor. The voltage at TS is monitored to determine that the battery is at a safe temperature during charging. The TS pin is not biased continuously, instead it is biased only when the voltage at the pin is being sampled (for about 25ms in 225ms intervals when VIN is present. Note that the TS biasing cannot be disabled when VIN is present.

The part can be configured to meet JEITA requirements or a simpler HOT/COLD function only. Additionally, the TS charger control function can be disabled. To satisfy the JEITA requirements, four temperature thresholds are monitored: the cold battery threshold, the cool battery threshold, the warm battery threshold, and the hot battery threshold. These temperatures correspond to the V_{COLD} , V_{COOL} , V_{WARM} , and V_{HOT} thresholds in the Electrical Characteristics table. Charging and safety timers are suspended when $V_{TS} < V_{HOT}$ or $V_{TS} > V_{COLD}$. When $V_{COOL} < V_{TS} < V_{COLD}$, the charging current is reduced to the value programmed in the [TS_FASTCHGCTRL](#) register. Note that the current steps for fast charge in the COOL region, just as those in normal fast charge, are multiples of the fast charge LSB value (1.25 mA by default). So in the case where the calculated scaled down current for the COOL region falls in between charge current steps, the device will round down the charge current to the nearest step. For example, if the fast charge current is set for 15 mA (ICHG = 1100) and TS_FASTCHARGE = 111 (0.125*ICHG), the charge current in the COOL region will be 1.25 mA instead of the calculated 1.85 mA.

When $V_{HOT} < V_{TS} < V_{WARM}$, the battery regulation voltage is reduced to the value programmed in the [TS_FASTCHGCTRL](#) register.

Regardless of whether the part is configured for JEITA, HOT/COLD, or disabled, when a TS fault occurs, a 128- μ s pulse is sent on the INT output, and the FAULT bits of the register are updated over I²C. The FAULT bits are not cleared until they are read over I²C. This allows the host processor to take action if a different behavior than the pre-set function is needed. Alternately, the TS pin voltage can be read by the host if VIN is present or when BAT is present, so the appropriate action can be taken by the host.

7.3.11.1 TS Thresholds

The BQ21061 monitors the TS voltage and sends an interrupt to the host whenever it crosses the V_{HOT} , V_{WARM} , V_{COOL} and V_{COLD} thresholds which correspond to different temperature thresholds based on the NTC resistance and biasing. These thresholds may be adjusted through I²C by the host. The device will also disable charging if TS pin exceeds the V_{TS_OPEN} threshold.

The TS biasing circuit is shown in [Figure 7-8](#). Note that the respective V_{TS} for T_{COLD} (0°C), T_{COOL} (10°C), T_{WARM} (45°C) and T_{HOT} (60°C) changes for every NTC, therefore the threshold values may need to be adjusted through I²C based on the supported NTC type.

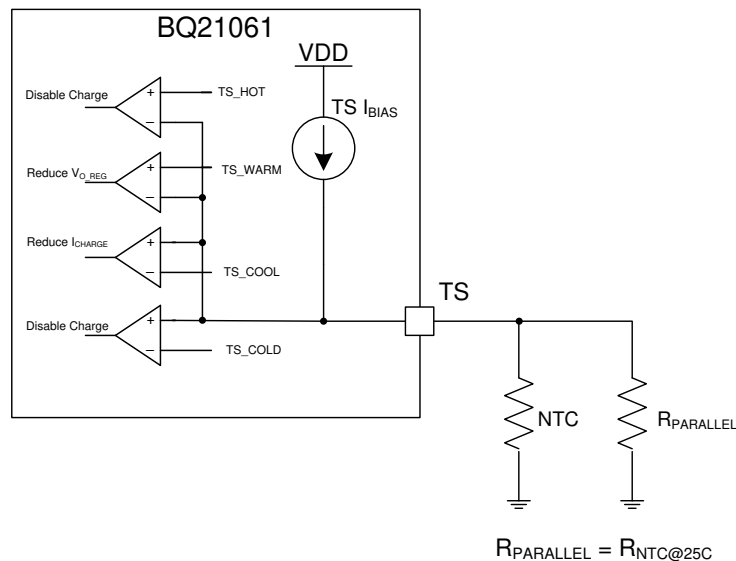

Figure 7-8. TS Bias Functional Diagram

The BQ21061 supports by default the following thresholds for a 10-K Ω NTC.

Table 7-4. TS Thresholds for 10-K Ω Thermistor with 3380 B-Constant

THRESHOLD	TEMPERATURE (°C)	VTS (V)
Open	--	>0.9
Cold	0	0.585
Cool	10	0.514
Warm	45	0.265
Hot	60	0.185

7.3.12 I²C Interface

The BQ21061 device uses a fully compliant I²C interface to program and read control parameters, status bits, and so on. I²C is a 2-wire serial interface developed by Philips Semiconductor (see I²C-Bus Specification, Version 2.1, January 2000). The bus consists of a data line (SDA) and a clock line (SCL) with pull-up structures. When the bus is idle, both SDA and SCL lines are pulled high. All the I²C compatible devices connect to the I²C bus through open drain I/O pins, SDA and SCL. A master device, usually a micro-controller or a digital signal processor, controls the bus. The master is responsible for generating the SCL signal and device addresses. The master also generates specific conditions that indicate the START and STOP of data transfer. A slave device receives and/or transmits data on the bus under control of the master device.

The BQ21061 works as a slave and supports the following data transfer modes, as defined in the I²C Bus Specification: standard mode (100 kbps) and fast mode (400 kbps). The interface adds flexibility to the battery charge solution, enabling most functions to be programmed to new values depending on the instantaneous application requirements.

Register contents remain intact as long as VBAT or VIN voltages remains above their respective UVLO levels.

The data transfer protocol for standard and fast modes is exactly the same; therefore, they are referred to as the F/S-mode in this document. The BQ21061 device 7-bit address is 0x6B (shifted 8-bit address is 0xD6).

7.3.12.1 F/S Mode Protocol

The master initiates data transfer by generating a start condition. The start condition is when a high-to-low transition occurs on the SDA line while SCL is high, as shown in Figure 7-9. All I²C-compatible devices should recognize a start condition.

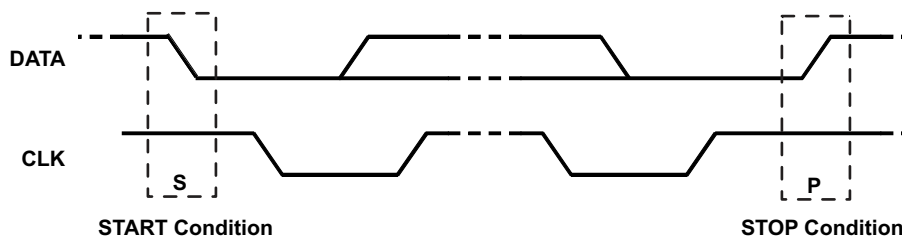
**Figure 7-9. START and STOP Condition**

The master then generates the SCL pulses, and transmits the 8-bit address and the read/write direction bit R/W on the SDA line. During all transmissions, the master ensures that data is valid. A valid data condition requires the SDA line to be stable during the entire high period of the clock pulse (see Figure 7-10). All devices recognize the address sent by the master and compare it to their internal fixed addresses. Only the slave device with a matching address generates an acknowledge (see Figure 7-11) by pulling the SDA line low during the entire high period of the ninth SCL cycle. Upon detecting this acknowledge, the master knows that communication link with a slave has been established.

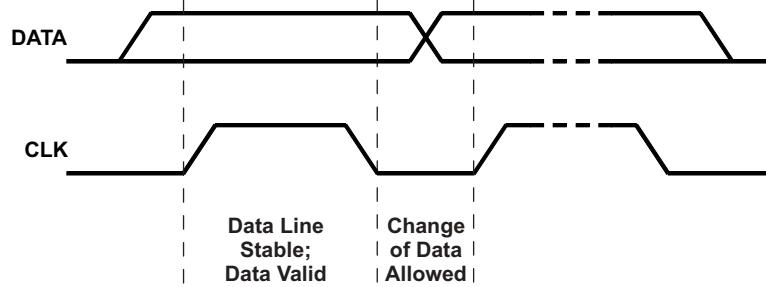

Figure 7-10. Bit Transfer on the Serial Interface

The master generates further SCL cycles to either transmit data to the slave (R/W bit 1) or receive data from the slave (R/W bit 0). In either case, the receiver needs to acknowledge the data sent by the transmitter. So an acknowledge signal can either be generated by the master or by the slave, depending on which one is the receiver. The 9-bit valid data sequences consisting of 8-bit data and 1-bit acknowledge can continue as long as necessary. To signal the end of the data transfer, the master generates a stop condition by pulling the SDA line from low to high while the SCL line is high (see Figure 7-9). This releases the bus and stops the communication link with the addressed slave. All I²C compatible devices must recognize the stop condition. Upon the receipt of a stop condition, all devices know that the bus is released, and wait for a start condition followed by a matching address. If a transaction is terminated prematurely, the master needs to send a STOP condition to prevent the slave I²C logic from remaining in an incorrect state. Attempting to read data from register addresses not listed in this section will result in FFh being read out.

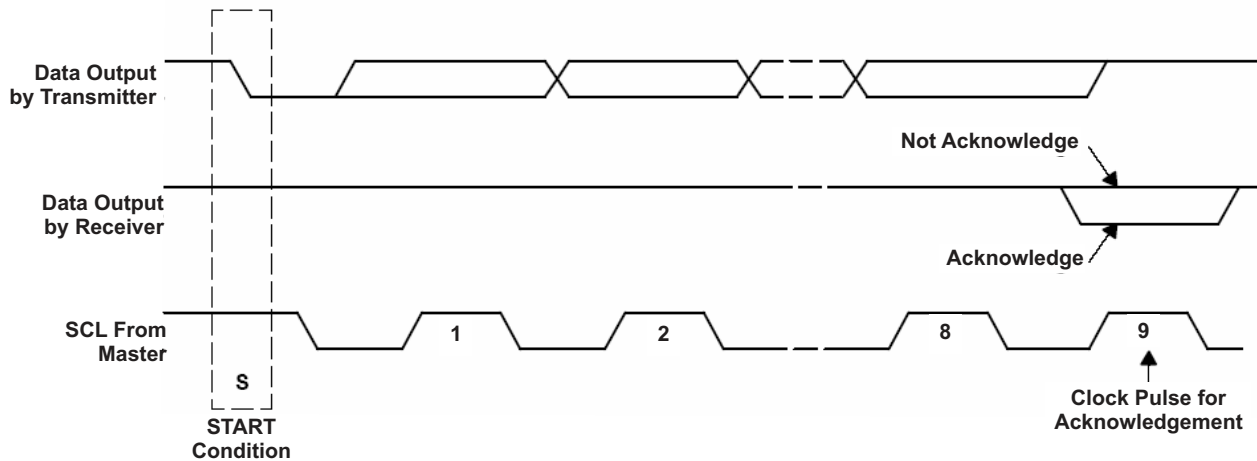

Figure 7-11. Acknowledge on the I²C Bus

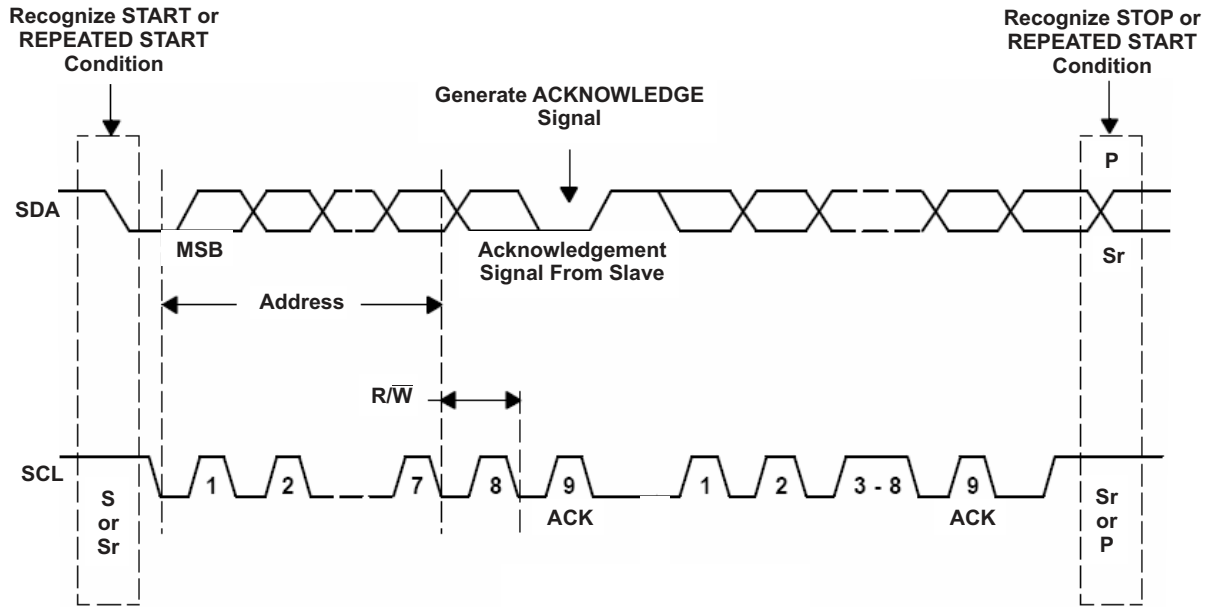

Figure 7-12. Bus Protocol

7.4 Device Functional Modes

The BQ21061 has four main modes of operation: Active Battery Mode, Low Power Mode and Ship Mode which are battery only modes and Charge/Adapter Mode when a supply is connected to IN. [Table 7-5](#) below summarizes the functions that are active for each operation mode. Each mode is discussed in further detail in the following sections in addition to the device's power-up/down sequences.

Table 7-5. Function Availability Based on Primary Mode of Operation

FUNCTION	CHARGE/ ADAPTER MODE	SHIP MODE	LOW POWER MODE	ACTIVE BATTERY MODE
VOVP	Yes	No	Yes	Yes
VUVLO	Yes	Yes	Yes	Yes
BATOCP	Yes	No	No	Yes
BATUVLO	Yes	No	Yes	Yes
VINDPM	If enabled	No	No	No
DPPM	If enabled	No	No	No
VDD	Yes	No	Yes	Yes
LS/LDO	Yes	No	If enabled	If enabled
BATFET	Yes	No	Yes	Yes
TS Measurement	Yes	No	No	If enabled
Battery Changing	If enabled	No	No	No
ILIM	Yes (Register Value)	No	No	No
\overline{MR} input	Yes	Yes	Yes	Yes
\overline{LP} input	No	No	Yes	Yes
\overline{INT} output	Yes	No	No	Yes
I ² C	Yes	No	No	Yes
\overline{CE} input	Yes	No	No	No

7.4.1 Ship Mode

Ship Mode is the lowest quiescent current state for the device. Ship Mode latches off the device and BAT FET until $V_{IN} > V_{UVLO}$ or the \overline{MR} button is depressed for t_{WAKE1} and released. Ship mode can be entered regardless of the state of \overline{CE} . The device will also enter Ship Mode upon battery insertion when no valid VIN is present. If the EN_SHIPMODE is written to a 1 while a valid input supply is connected, the device will wait until the IN supply is removed to enter ship mode. If the \overline{MR} pin is held low when the EN_SHIPMODE bit is set, the device will wait until the \overline{MR} pin goes high before entering Ship Mode. [Figure 7-13](#) shows this behavior. The battery voltage must be above the maximum programmable $V_{BATUVLO}$ threshold in order to exit Ship Mode with \overline{MR} press. The EN_SHIPMODE bit can be cleared using the I²C interface while the VIN input is valid. The EN_SHIPMODE bit is not cleared upon the I²C watchdog expiring, this means that if watchdog timer fault occurs while the EN_SHIPMODE bit is set and the device is waiting to go into Ship Mode because V_{IN} is present or \overline{MR} is low, the device will still proceed to go into Ship Mode once those conditions are cleared.

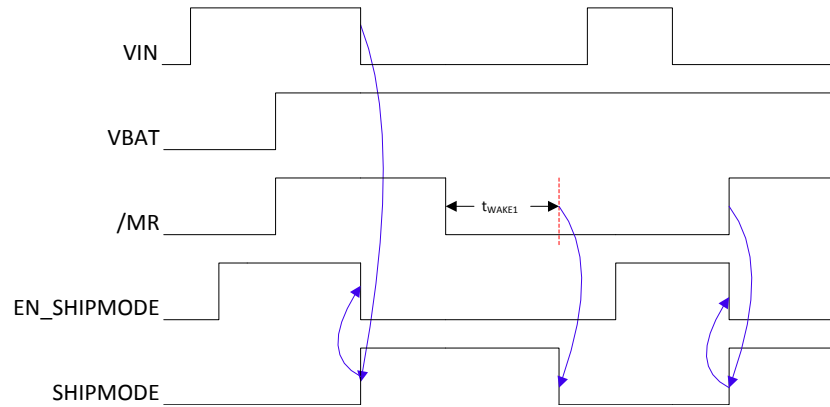

Figure 7-13. Ship Mode Entry Based On EN_SHIPMODE bit

7.4.2 Low Power

Low Power mode is a low quiescent current state while operating from the battery. The device will operate in low power mode when the $\overline{\text{LP}}$ pin is set low, $V_{\text{IN}} < V_{\text{UVLO}}$, $\overline{\text{MR}}$ pin is high and all I²C transactions and interrupts that started while in the Active Battery or Charging Modes have been completed and sent. During LP mode the VDD output is powered by BAT, the $\overline{\text{MR}}$ inputs are active and the I²C is disabled. All other circuits, such as oscillators, are in a low power or off state. The LS/LDO outputs will remain in the state set by the EN_LS_LDO bit prior to entering Low Power Mode. The device exits LP Mode when the $\overline{\text{LP}}$ pin is set high or $V_{\text{IN}} > V_{\text{UVLO}}$.

In the case that a faulty adapter with $V_{\text{IN}} > V_{\text{OVP}}$ is connected to the device while $\overline{\text{LP}}$ pin is low, the device will be powered from the battery, but will operate in Active battery mode instead of Low Power mode regardless of the $\overline{\text{LP}}$ pin state.

When $\overline{\text{MR}}$ is held low while $\overline{\text{LP}}$ is low, the device will enter Active Battery Mode, this allows for the internal clocks of the device to be running and allow the $\overline{\text{MR}}$ long button press HW reset. I²C operation is also possible during this condition. Note that as soon as the $\overline{\text{MR}}$ input is released and goes high, the device will go back to LP Mode tuning off all clocks. Note that if a HW reset has occurred while $\overline{\text{LP}}$ is low, $\overline{\text{MR}}$ must remain low until the power up sequence has completed (PMID and LDO enable) to allow completion of the power up sequence.

7.4.3 Active Battery

When the device is out of Ship Mode and battery is above V_{BATUVLO} with no valid input source, the battery discharge FET is turned on connecting PMID to the battery. The current flowing from BAT to PMID is not regulated, but it is monitored by the battery over-current protection (OCP) circuitry. If the battery discharge current exceed the OCP threshold, the battery discharge FET will be turned off as detailed in the [Section 7.3.2.4](#).

If only battery is connected and the battery voltage goes below V_{BATUVLO} , the battery discharge FET is turned off. To provide designers the most flexibility in optimizing their system, an adjustable BATUVLO is provided. Deeper discharge of the battery enables longer times between charging, but may shorten the battery life. The BATUVLO is adjustable with a fixed 150-mV hysteresis.

7.4.4 Charger/Adapter Mode

This mode is active when $V_{\text{IN}} > V_{\text{UVLO}}$. If the supply at IN is valid and above the $V_{\text{IN_DPM}}$ level, PMID will be powered by the supply connected to IN. The device will charge the battery, if charging is enabled, until termination has occurred.

7.4.5 Power-Up/Down Sequencing

The power-up and power-down sequences for the BQ21061 are shown below. Upon V_{IN} insertion, $V_{\text{IN}} > V_{\text{UVLO}}$, the device wakes up, powering the VDD rail. If $V_{\text{IN}} > V_{\text{BAT}} + V_{\text{SLP}}$ and $V_{\text{IN}} < V_{\text{OVP}}$, PMID will be powered by VIN and if $V_{\text{IN}} > V_{\text{IN_DPM}}$ charging will start if enabled.

In the case where $V_{\text{IN}} < V_{\text{UVLO}}$ and the battery is inserted ($V_{\text{BAT}} > V_{\text{BATUVLO}}$), the device will immediately enter Ship Mode unless $\overline{\text{MR}}$ is held low. Upon battery insertion the VDD rail will come up to allow the device to check the $\overline{\text{MR}}$ state and if $\overline{\text{MR}}$ is high VDD will immediately be disabled and the device will enter Ship Mode. If $\overline{\text{MR}}$ is

low, the device will start the WAKE timer and power up PMID and other rails if \overline{MR} is held low for longer than t_{WAKE1} .

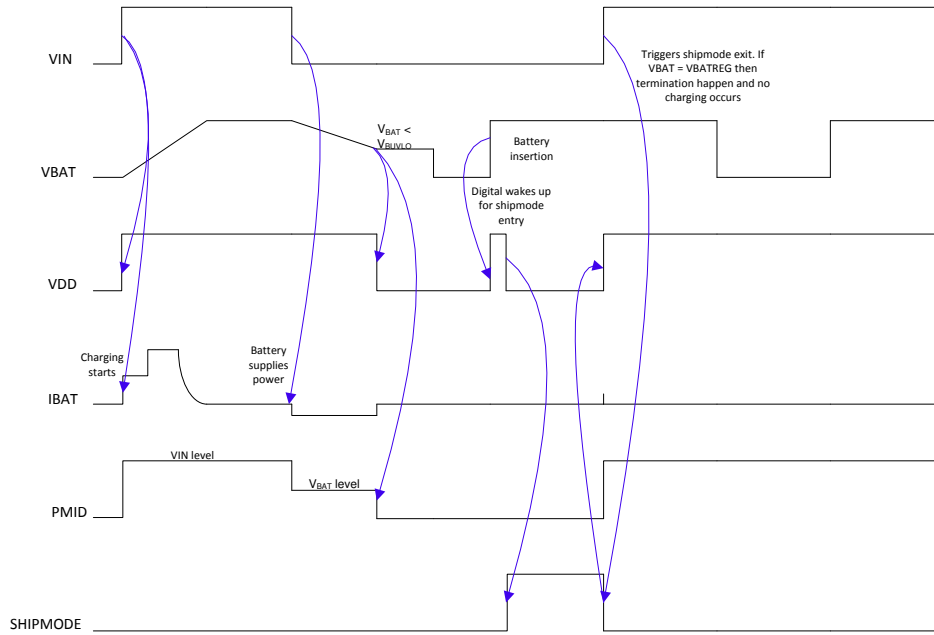

Figure 7-14. BQ21061 Wake-Up Upon Supply Insertion

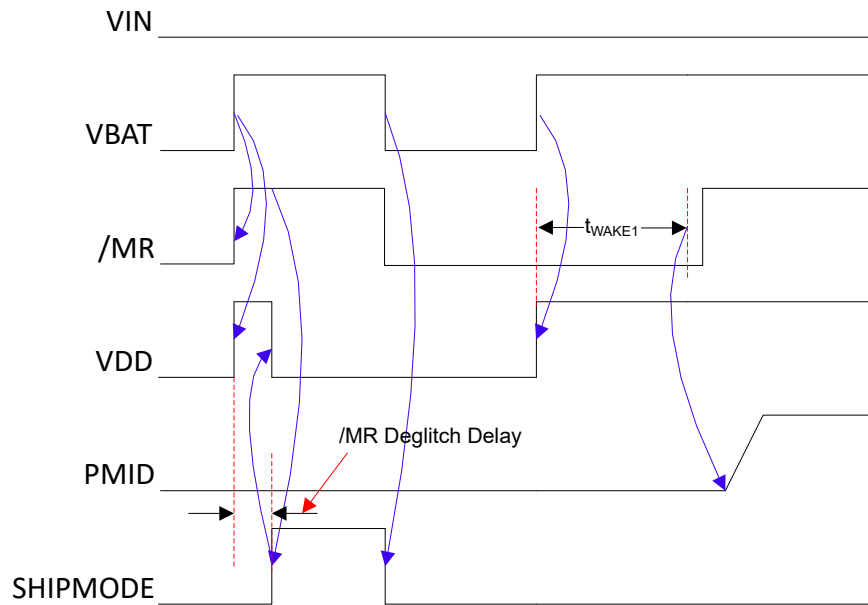

Figure 7-15. BQ21061 Wake-Up Upon Battery Insertion

7.5 Register Map

The device 7-bit address I²C is 0x6B (shifted 8-bit address is 0xD6).

7.5.1 I²C Registers

Table 7-6 lists the memory-mapped registers for the I²C registers. All register offset addresses not listed in Table 7-6 should be considered as reserved locations and the register contents should not be modified.

Table 7-6. I²C Registers

Address	Acronym	Register Name	Section
0x0	STAT0	Charger Status 0	Go
0x1	STAT1	Charger Status 1	Go
0x2	STAT2	Status 2	Go
0x3	FLAG0	Charger Flags 0	Go
0x4	FLAG1	Charger Flags 1	Go
0x5	FLAG2	Flags 2	Go
0x6	FLAG3	Timer Flags	Go
0x7	MASK0	Interrupt Masks 0	Go
0x8	MASK1	Interrupt Masks 1	Go
0x9	MASK2	Interrupt Masks 2	Go
0xA	MASK3	Interrupt Masks 3	Go
0x12	VBAT_CTRL	Battery Voltage Control	Go
0x13	ICHG_CTRL	Fast Charge Current Control	Go
0x14	PCHRGCTRL	Pre-Charge Current Control	Go
0x15	TERMCTRL	Termination Current Control	Go
0x16	BUVLO	Battery UVLO and Current Limit Control	Go
0x17	CHARGERCTRL0	Charger Control 0	Go
0x18	CHARGERCTRL1	Charger Control 1	Go
0x19	ILIMCTRL	Input Current Limit Control	Go
0x1D	LDOCTRL	LDO Control	Go
0x30	MRCTRL	MR Control	Go
0x35	ICCTRL0	IC Control 0	Go
0x36	ICCTRL1	IC Control 1	Go
0x37	ICCTRL2	IC Control 2	Go
0x61	TS_FASTCHGCTRL	TS Charge Control	Go
0x62	TS_COLD	TS Cold Threshold	Go
0x63	TS_COOL	TS Cool Threshold	Go
0x64	TS_WARM	TS Warm Threshold	Go
0x65	TS_HOT	TS Hot Threshold	Go
0x6F	DEVICE_ID	Device ID	Go

Complex bit access types are encoded to fit into small table cells. Table 7-7 shows the codes that are used for access types in this section.

Table 7-7. I²C Access Type Codes

Access Type	Code	Description
Read Type		
R	R	Read
RC	C R	to Clear Read

Table 7-7. I²C Access Type Codes (continued)

Access Type	Code	Description
Write Type		
W	W	Write
Reset or Default Value		
-n		Value after reset or the default value

7.5.1.1 STAT0 Register (Address = 0x0) [reset = X]

STAT0 is shown in [Figure 7-16](#) and described in [Table 7-8](#).

Return to [Summary Table](#).

Figure 7-16. STAT0 Register

7	6	5	4	3	2	1	0
RESERVED	CHRG_CV_STAT	CHARGE_DONE_STAT	IINLIM_ACTIVE_STAT	VDPPM_ACTIVE_STAT	VINDPM_ACTIVE_STAT	THERMREG_ACTIVE_STAT	VIN_PGOOD_STAT
R-X	R-X	R-X	R-X	R-X	R-X	R-X	R-X

Table 7-8. STAT0 Register Field Descriptions

Bit	Field	Type	Reset	Description
7	RESERVED	R	X	Reserved
6	CHRG_CV_STAT	R	X	Constant Voltage Charging Mode (Taper Mode) Status 1b0 = Not Active 1b1 = Active
5	CHARGE_DONE_STAT	R	X	Charge Done Status 1b0 = Not Active 1b1 = Active
4	IINLIM_ACTIVE_STAT	R	X	Input Current Limit Status 1b0 = Not Active 1b1 = Active
3	VDPPM_ACTIVE_STAT	R	X	DPPM Status 1b0 = Not Active 1b1 = Active
2	VINDPM_ACTIVE_STAT	R	X	VINDPM Status 1b0 = Not Active 1b1 = Active
1	THERMREG_ACTIVE_STAT	R	X	Thermal Regulation Status 1b0 = Not Active 1b1 = Active
0	VIN_PGOOD_STAT	R	X	VIN Power Good Status 1b0 = Not Good 1b1 = $V_{IN} > V_{UVLO}$ and $V_{IN} > V_{BAT} + V_{SLP}$ and $V_{IN} < V_{OVP}$

7.5.1.2 STAT1 Register (Address = 0x1) [reset = X]

STAT1 is shown in [Figure 7-17](#) and described in [Table 7-9](#).

Return to [Summary Table](#).

Figure 7-17. STAT1 Register

7	6	5	4	3	2	1	0
VIN_OVP_FAULT_STAT	RESERVED	BAT_OCP_FAULT_STAT	BAT_UVLO_FAULT_STAT	TS_COLD_STAT	TS_COOL_STAT	TS_WARM_STAT	TS_HOT_STAT
R-X	R-X	R-X	R-X	R-X	R-X	R-X	R-X

Table 7-9. STAT1 Register Field Descriptions

Bit	Field	Type	Reset	Description
7	VIN_OVP_FAULT_STAT	R	X	VIN Overvoltage Status 1b0 = Not Active 1b1 = Active
6	RESERVED	R	X	Reserved
5	BAT_OCP_FAULT_STAT	R	X	Battery Over-Current Protection Status 1b0 = Not Active 1b1 = Active
4	BAT_UVLO_FAULT_STAT	R	X	Battery voltage below BATUVLO Level Status 1b0 = $V_{BAT} > V_{BATUVLO}$ 1b1 = $V_{BAT} < V_{BATUVLO}$
3	TS_COLD_STAT	R	X	TS Cold Status - $V_{TS} > V_{COLD}$ (charging suspended) 1b0 = Not Active 1b1 = Active
2	TS_COOL_STAT	R	X	TS Cool Status - $V_{COOL} < V_{TS} < V_{COLD}$ (charging current reduced by value set by TS_Registers) 1b0 = Not Active 1b1 = Active
1	TS_WARM_STAT	R	X	TS Warm - $V_{WARM} > V_{TS} > V_{HOT}$ (charging voltage reduced by value set by TS_Registers) 1b0 = Not Active 1b1 = Active
0	TS_HOT_STAT	R	X	TS Hot Status - $V_{TS} < V_{HOT}$ (charging suspended) 1b0 = Not Active 1b1 = Active

7.5.1.3 STAT2 Register (Address = 0x2) [reset = X]

STAT2 is shown in [Figure 7-18](#) and described in [Table 7-10](#).

Return to [Summary Table](#).

Figure 7-18. STAT2 Register

7	6	5	4	3	2	1	0
RESERVED							TS_OPEN_STAT
R-X	R-X	R-X	R-X		R-X		R-X

Table 7-10. STAT2 Register Field Descriptions

Bit	Field	Type	Reset	Description
7-4	RESERVED	R	X	Reserved
3-1	RESERVED	R	X	Reserved

Table 7-10. STAT2 Register Field Descriptions (continued)

Bit	Field	Type	Reset	Description
0	TS_OPEN_STAT	R	X	TS Open Status 1b0 = $V_{TS} < V_{OPEN}$ 1b1 = $V_{TS} > V_{OPEN}$

7.5.1.4 FLAG0 Register (Address = 0x3) [reset = 0x0]

FLAG0 is shown in [Figure 7-19](#) and described in [Table 7-11](#).

Return to [Summary Table](#).

Clear on Read

Figure 7-19. FLAG0 Register

7	6	5	4	3	2	1	0
RESERVED	CHRG_CV_FL AG	CHARGE_DON E_FLAG	IINLIM_ACTIVE _FLAG	VDPPM_ACTIV E_FLAG	VINDPM_ACTI VE_FLAG	THERMREG_A CTIVE_FLAG	VIN_PGOOD_F LAG
RC-1b0	RC-1b0	RC-1b0	RC-1b0	RC-1b0	RC-1b0	RC-1b0	RC-1b0

Table 7-11. FLAG0 Register Field Descriptions

Bit	Field	Type	Reset	Description
7	RESERVED	RC	1b0	Reserved
6	CHRG_CV_FLAG	RC	1b0	Constant Voltage Charging Mode (Taper Mode) Flag 1b0 = CV Mode Entry not detected 1b1 = CV Mode Entry detected
5	CHARGE_DONE_FLAG	RC	1b0	Charge Done Flag 1b0 = Charge Done (Termination) not detected 1b1 = Charge Done (Termination) detected
4	IINLIM_ACTIVE_FLAG	RC	1b0	Input Current Limit Flag 1b0 = Input Current Limit not detected 1b1 = Input Current Limit detected
3	VDPPM_ACTIVE_FLAG	RC	1b0	DPPM Flag 1b0 = DPPM operation not detected 1b1 = DPPM operation detected
2	VINDPM_ACTIVE_FLAG	RC	1b0	VINDPM Flag 1b0 = VINDPM operation not detected 1b1 = VIINDPM operation detected
1	THERMREG_ACTIVE_FL AG	RC	1b0	Thermal Regulation Flag 1b0 = Thermal Regulation not detected 1b1 = Thermal Regulation detected
0	VIN_PGOOD_FLAG	RC	1b0	VIN Power Good Flag . Interrupt will not be sent if device powers up with VIN_PGOOD condition and $V_{BAT} < V_{BATUVLO}$ 1b0 = No change in VIN Power Good Status 1b1 = Change in VIN Power Good Status detected.

7.5.1.5 FLAG1 Register (Address = 0x4) [reset = 0x0]

FLAG1 is shown in [Figure 7-20](#) and described in [Table 7-12](#).

Return to [Summary Table](#).

Clear on Read

Figure 7-20. FLAG1 Register

7	6	5	4	3	2	1	0
VIN_OVP_FAULT_FLAG	RESERVED	BAT_OCP_FAULT_FLAG	BAT_UVLO_FAULT_FLAG	TS_COLD_FLAG	TS_COOL_FLAG	TS_WARM_FLAG	TS_HOT_FLAG
RC-1b0	RC-1b0	RC-1b0	RC-1b0	RC-1b0	RC-1b0	RC-1b0	RC-1b0

Table 7-12. FLAG1 Register Field Descriptions

Bit	Field	Type	Reset	Description
7	VIN_OVP_FAULT_FLAG	RC	1b0	VIN Over Voltage Fault Flag 1b0 = No overvoltage condition detected 1b1 = VIN overvoltage condition detected
6	RESERVED	RC	1b0	Reserved
5	BAT_OCP_FAULT_FLAG	RC	1b0	Battery Over Current Protection Flag 1b0 = No Battery Over Current condition detected 1b1 = Battery Over Current condition detected
4	BAT_UVLO_FAULT_FLAG	RC	1b0	Battery Under Voltage Flag 1b0 = Battery below BATUVLO condition detected 1b1 = No Battery below BATUVLO condition detected
3	TS_COLD_FLAG	RC	1b0	TS Cold Region Entry Flag 1b0 = TS Cold Region Entry not detected 1b1 = TS Cold Region Entry detected
2	TS_COOL_FLAG	RC	1b0	TS Cool Region Entry Flag 1b0 = TS Cool Region Entry not detected 1b1 = TS Cool Region Entry detected
1	TS_WARM_FLAG	RC	1b0	TS Warm Region Entry Flag 1b0 = TS Warm Region Entry not detected 1b1 = TS Warm Region Entry detected
0	TS_HOT_FLAG	RC	1b0	TS Hot Region Entry Flag 1b0 = TS Hot Region Entry not detected 1b1 = TS Hot Region Entry detected

7.5.1.6 FLAG2 Register (Address = 0x5) [reset = 0x0]

FLAG2 is shown in [Figure 7-21](#) and described in [Table 7-13](#).

Return to [Summary Table](#).

Clear on Read

Figure 7-21. FLAG2 Register

7	6	5	4	3	2	1	0
RESERVED						TS_OPEN_FLAG	
RC-1b0	RC-1b0	RC-1b0	RC-1b0	RC-3b000		RC-1b0	

Table 7-13. FLAG2 Register Field Descriptions

Bit	Field	Type	Reset	Description
7-4	RESERVED	R	X	Reserved
3-1	RESERVED	RC	3b000	Reserved
0	TS_OPEN_FLAG	RC	1b0	TS Open Flag 1b0 = No TS Open fault detected 1b1 = TS Open fault detected

7.5.1.7 FLAG3 Register (Address = 0x6) [reset = 0x0]

FLAG3 is shown in [Figure 7-22](#) and described in [Table 7-14](#).

Return to [Summary Table](#).

Clear on Read

Figure 7-22. FLAG3 Register

7	6	5	4	3	2	1	0
RESERVED	WD_FAULT_FL AG	SAFETY_TMR_ FAULT_FLAG	LDO_OCP_FA ULT_FLAG	RESERVED	MRWAKE1_TI MEOU_FLAG	MRWAKE2_TI MEOU_FLAG	MRRESET_WA RN_FLAG
RC-1b0	RC-1b0	RC-1b0	RC-1b0	RC-1b0	RC-1b0	RC-1b0	RC-1b0

Table 7-14. FLAG3 Register Field Descriptions

Bit	Field	Type	Reset	Description
7	RESERVED	RC	1b0	Reserved
6	WD_FAULT_FLAG	RC	1b0	Watchdog Fault Flag 1b0 = Watchdog Timer not expired 1b1 = Watchdog Timer expired
5	SAFETY_TMR_FAULT_F LAG	RC	1b0	Safety Timer Fault Flag 1b0 = Safety Timer not expired 1b1 = Safety Timer Expired
4	LDO_OCP_FAULT_FLAG	RC	1b0	LDO Over Current Fault 1b0 = LDO Normal 1b1 = LDO Over current fault detected
2	MRWAKE1_TIMEOUT_FL AG	RC	1b0	MR Wake 1 Timer Flag 1b0 = MR Wake 1 timer not expired 1b1 = MR Wake 1 timer expired
1	MRWAKE2_TIMEOUT_FL AG	RC	1b0	MR Wake 2 Timer Flag 1b0 = MR Wake 2 timer not expired 1b1 = MR Wake 2 timer expired
0	MRRESET_WARN_FLAG	RC	1b0	MR Reset Warn Timer Flag 1b0 = MR Reset Warn timer not expired 1b1 = MR Reset Warn timer expired

7.5.1.8 MASK0 Register (Address = 0x7) [reset = 0x0]

MASK0 is shown in [Figure 7-23](#) and described in [Table 7-15](#).

Return to [Summary Table](#).

Figure 7-23. MASK0 Register

7	6	5	4	3	2	1	0
RESERVED	CHRG_CV_MA SK	CHARGE_DON E_MASK	IINLIM_ACTIVE _MASK	VDPPM_ACTIV E_MASK	VINDPM_ACTI VE_MASK	THERMREG_A CTIVE_MASK	VIN_PGOOD_ MASK
R/W-1b0	R/W-1b0	R/W-1b0	R/W-1b0	R/W-1b0	R/W-1b0	R/W-1b0	R/W-1b0

Table 7-15. MASK0 Register Field Descriptions

Bit	Field	Type	Reset	Description
7	RESERVED	R/W	1b0	Reserved 1b0 = Interrupt Not Masked 1b1 = Interrupt Masked

Table 7-15. MASK0 Register Field Descriptions (continued)

Bit	Field	Type	Reset	Description
6	CHRG_CV_MASK	R/W	1b0	Mask for CHRG_CV interrupt 1b0 = Interrupt Not Masked 1b1 = Interrupt Masked
5	CHARGE_DONE_MASK	R/W	1b0	Mask for CHARGE_DONE interrupt 1b0 = Interrupt Not Masked 1b1 = Interrupt Masked
4	IINLIM_ACTIVE_MASK	R/W	1b0	Mask for IINLIM_ACTIVE interrupt 1b0 = Interrupt Not Masked 1b1 = Interrupt Masked
3	VDPPM_ACTIVE_MASK	R/W	1b0	Mask for VDPPM_ACTIVE interrupt 1b0 = Interrupt Not Masked 1b1 = Interrupt Masked
2	VINDPM_ACTIVE_MASK	R/W	1b0	Mask for VINDPM_ACTIVE interrupt 1b0 = Interrupt Not Masked 1b1 = Interrupt Masked
1	THERMREG_ACTIVE_MASK	R/W	1b0	Mask for THERMREG_ACTIVE interrupt 1b0 = Interrupt Not Masked 1b1 = Interrupt Masked
0	VIN_PGOOD_MASK	R/W	1b0	Mask for VIN_PGOOD interrupt 1b0 = Interrupt Not Masked 1b1 = Interrupt Masked

7.5.1.9 MASK1 Register (Address = 0x8) [reset = 0x0]

MASK1 is shown in [Figure 7-24](#) and described in [Table 7-16](#).

Return to [Summary Table](#).

Figure 7-24. MASK1 Register

7	6	5	4	3	2	1	0
VIN_OVP_FAULT_MASK	RESERVED	BAT_OCP_FAULT_MASK	BAT_UVLO_FAULT_MASK	TS_COLD_MASK	TS_COOL_MASK	TS_WARM_MASK	TS_HOT_MASK
R/W-1b0	R/W-1b0	R/W-1b0	R/W-1b0	R/W-1b0	R/W-1b0	R/W-1b0	R/W-1b0

Table 7-16. MASK1 Register Field Descriptions

Bit	Field	Type	Reset	Description
7	VIN_OVP_FAULT_MASK	R/W	1b0	Mask for VIN_OVP_FAULT interrupt 1b0 = Interrupt Not Masked 1b1 = Interrupt Masked
6	RESERVED	R/W	1b0	Reserved
5	BAT_OCP_FAULT_MASK	R/W	1b0	Mask for BAT_OCP_FAULT interrupt 1b0 = Interrupt Not Masked 1b1 = Interrupt Masked
4	BAT_UVLO_FAULT_MASK	R/W	1b0	Mask for BAT_UVLO_FAULT interrupt 1b0 = Interrupt Not Masked 1b1 = Interrupt Masked
3	TS_COLD_MASK	R/W	1b0	Mask for TS_COLD interrupt 1b0 = Interrupt Not Masked 1b1 = Interrupt Masked

Table 7-16. MASK1 Register Field Descriptions (continued)

Bit	Field	Type	Reset	Description
2	TS_COOL_MASK	R/W	1b0	Mask for TS_COOL interrupt 1b0 = Interrupt Not Masked 1b1 = Interrupt Masked
1	TS_WARM_MASK	R/W	1b0	Mask for TS_WARM interrupt 1b0 = Interrupt Not Masked 1b1 = Interrupt Masked
0	TS_HOT_MASK	R/W	1b0	Mask for TS_HOT interrupt 1b0 = Interrupt Not Masked 1b1 = Interrupt Masked

7.5.1.10 MASK2 Register (Address = 0x9) [reset = 0x71]

MASK2 is shown in [Figure 7-25](#) and described in [Table 7-17](#).

Return to [Summary Table](#).

Figure 7-25. MASK2 Register

7	6	5	4	3	2	1	0
RESERVED							TS_OPEN_MASK
R/W-1b0	R/W-1b1	R/W-1b1	R/W-1b1		R/W-3b000		R/W-1b1

Table 7-17. MASK2 Register Field Descriptions

Bit	Field	Type	Reset	Description
7	RESERVED	R	X	Reserved
6	RESERVED	R	X	Reserved
5	RESERVED	R	X	Reserved
4	RESERVED	R	X	Reserved
3-1	RESERVED	R/W	3b000	Reserved
0	TS_OPEN_MASK	R/W	1b1	Mask for TS_OPEN Interrupt 1b0 = Interrupt Not Masked 1b1 = Interrupt Masked

7.5.1.11 MASK3 Register (Address = 0xA) [reset = 0x0]

MASK3 is shown in [Figure 7-26](#) and described in [Table 7-18](#).

Return to [Summary Table](#).

Figure 7-26. MASK3 Register

7	6	5	4	3	2	1	0
RESERVED	WD_FAULT_MASK	SAFETY_TMR_FAULT_MASK	LDO_OCP_FAULT_MASK	RESERVED	MRWAKE1_TIMEOUT_MASK	MRWAKE2_TIMEOUT_MASK	MRRESET_WARN_MASK
R/W-1b0	R/W-1b0	R/W-1b0	R/W-1b0	R/W-1b0	R/W-1b0	R/W-1b0	R/W-1b0

Table 7-18. MASK3 Register Field Descriptions

Bit	Field	Type	Reset	Description
7	RESERVED	R/W	1b0	Reserved
6	WD_FAULT_MASK	R/W	1b0	Mask for WD_FAULT Interrupt 1b0 = Interrupt Not Masked 1b1 = Interrupt Masked

Table 7-18. MASK3 Register Field Descriptions (continued)

Bit	Field	Type	Reset	Description
5	SAFETY_TMR_FAULT_MASK	R/W	1b0	Mask for SAFETY_TIMER_FAULT Interrupt 1b0 = Interrupt Not Masked 1b1 = Interrupt Masked
4	LDO_OCP_FAULT_MASK	R/W	1b0	Mask for LDO_OCP_FAULT Interrupt 1b0 = Interrupt Not Masked 1b1 = Interrupt Masked
3	RESERVED	R/W	1b0	Reserved
2	MRWAKE1_TIMEOUT_MASK	R/W	1b0	Mask for MRWAKE1_TIMEOUT Interrupt 1b0 = Interrupt Not Masked 1b1 = Interrupt Masked
1	MRWAKE2_TIMEOUT_MASK	R/W	1b0	Mask for MRWAKE2_TIMEOUT Interrupt 1b0 = Interrupt Not Masked 1b1 = Interrupt Masked
0	MRRESET_WARN_MASK	R/W	1b0	Mask for MRRESET_WARN Interrupt 1b0 = Interrupt Not Masked 1b1 = Interrupt Masked

7.5.1.12 VBAT_CTRL Register (Address = 0x12) [reset = 0x3C]

VBAT_CTRL is shown in [Figure 7-27](#) and described in [Table 7-19](#).

Return to [Summary Table](#).

Figure 7-27. VBAT_CTRL Register

7	6	5	4	3	2	1	0
RESERVED	VBAT_REG_6:0						
R/W-1b0	R/W-7b0111100						

Table 7-19. VBAT_CTRL Register Field Descriptions

Bit	Field	Type	Reset	Description
7	RESERVED	R/W	1b0	Reserved
6-0	VBAT_REG_6:0	R/W	7b0111100	Battery Regulation Voltage (4.2 V default) VBATREG = 3.6 V + VBAT_REG code x 10 mV If a value greater than 4.6 V is written, the setting will go to 4.6 V

7.5.1.13 ICHG_CTRL Register (Address = 0x13) [reset = 0x8]

ICHG_CTRL is shown in [Figure 7-28](#) and described in [Table 7-20](#).

Return to [Summary Table](#).

Figure 7-28. ICHG_CTRL Register

7	6	5	4	3	2	1	0
ICHG_7:0							
R/W-8b00001000							

Table 7-20. ICHG_CTRL Register Field Descriptions

Bit	Field	Type	Reset	Description
7-0	ICHG_7:0	R/W	8b00001000	Fast Charge Current (10 mA default) Fast Charge Current = 1.25 mA x ICHG code (ICHARGE_RANGE = 0) Fast Charge Current = 2.5 mA x ICHG code (ICHARGE_RANGE = 1)

7.5.1.14 PCHRGCTRL Register (Address = 0x14) [reset = 0x2]

PCHRGCTRL is shown in [Figure 7-29](#) and described in [Table 7-21](#).

Return to [Summary Table](#).

Figure 7-29. PCHRGCTRL Register

7	6	5	4	3	2	1	0
ICHARGE_RANGE	RESERVED		IPRECHG_4:0				
R/W-1b0	R/W-2b00		R/W-5b00010				

Table 7-21. PCHRGCTRL Register Field Descriptions

Bit	Field	Type	Reset	Description
7	ICHARGE_RANGE	R/W	1b0	Charge Current Step 1b0 = 1.25 mA step (318.75 mA max charge current) 1b1 = 2.5 mA step (500 mA max charge current)
6-5	RESERVED	R/W	2b00	Reserved
4-0	IPRECHG_4:0	R/W	5b00010	Pre-Charge Current (2.5 mA default) Pre-Charge Current = 1.25 mA x IPRECHG code (ICHARGE_RANGE = 0) Pre-Charge Current = 2.5 mA x IPRECHG code (ICHARGE_RANGE = 1)

7.5.1.15 TERMCTRL Register (Address = 0x15) [reset = 0x14]

TERMCTRL is shown in [Figure 7-30](#) and described in [Table 7-22](#).

Return to [Summary Table](#).

Figure 7-30. TERMCTRL Register

7	6	5	4	3	2	1	0
RESERVED		ITERM_4:0				TERM_DISABLE	
R/W-2b00		R/W-5b01010				R/W-1b0	

Table 7-22. TERMCTRL Register Field Descriptions

Bit	Field	Type	Reset	Description
7-6	RESERVED	R/W	2b00	Reserved
5-1	ITERM_4:0	R/W	5b01010	Termination Current (10% of ICHRG default) Programmable Range = 1% to 31% of ICHRG 5b00000 = Do not Use 5b00001 = 1% of ICHRG 5b00010 = 2% of ICHRG 5b00100 = 4% of ICHRG 5b01000 = 8% of ICHRG 5b10000 = 16% of ICHRG

Table 7-22. TERMCTRL Register Field Descriptions (continued)

Bit	Field	Type	Reset	Description
0	TERM_DISABLE	R/W	1b0	Termination Disable 1b0 = Termination Enabled 1b1 = Termination Disabled

7.5.1.16 BUVLO Register (Address = 0x16) [reset = 0x0]

BUVLO is shown in [Figure 7-31](#) and described in [Table 7-23](#).

Return to [Summary Table](#).

Figure 7-31. BUVLO Register

7	6	5	4	3	2	1	0
RESERVED		VLOWV_SEL	IBAT_OCP_ILIM_1:0		BUVLO_2:0		
R/W-2b00		R/W-1b0	R/W-2b00		R/W-3b000		

Table 7-23. BUVLO Register Field Descriptions

Bit	Field	Type	Reset	Description
7-6	RESERVED	R/W	2b00	Reserved
5	VLOWV_SEL	R/W	1b0	Pre-charge to Fast Charge Threshold 1b0 = 3.0 V 1b1 = 2.8 V
4-3	IBAT_OCP_ILIM_1:0	R/W	2b00	Battery Over-Current Protection Threshold 2b00 = 1200 mA 2b01 = 1500 mA 2b10 = Disabled 2b11 = Disabled
2-0	BUVLO_2:0	R/W	3b000	Battery UVLO Voltage 3b000 = 3.0 V 3b001 = 3.0 V 3b010 = 3.0 V 3b011 = 2.8 V 3b100 = 2.6 V 3b101 = 2.4 V 3b110 = 2.2 V 3b111 = Disabled

7.5.1.17 CHARGERCTRL0 Register (Address = 0x17) [reset = 0x82]

CHARGERCTRL0 is shown in [Figure 7-32](#) and described in [Table 7-24](#).

Return to [Summary Table](#).

Figure 7-32. CHARGERCTRL0 Register

7	6	5	4	3	2	1	0
TS_EN	TS_CONTROL_MODE	VRH_THRESH	WATCHDOG_DISABLE	2XTMR_EN	SAFETY_TIMER_LIMIT_1:0		RESERVED
R/W-1b1	R/W-1b0	R/W-1b0	R/W-1b0	R/W-1b0	R/W-2b01		R/W-1b0

Table 7-24. CHARGERCTRL0 Register Field Descriptions

Bit	Field	Type	Reset	Description
7	TS_EN	R/W	1b1	TS Function Enable 1b0 = TS function disabled (Only charge control is disabled. TS_OPEN detection and TS ADC monitoring remain enabled) 1b1 = TS function enabled
6	TS_CONTROL_MODE	R/W	1b0	TS Function Control Mode 1b0 = Custom (JEITA) 1b1 = Disable charging on HOT/COLD Only
5	VRH_THRESH	R/W	1b0	Recharge Voltage Threshold 1b0 = 140 mV 1b1 = 200 mV
4	WATCHDOG_DISABLE	R/W	1b0	Watchdog Timer Disable 1b0 = Watchdog timer enabled 1b1 = Watchdog timer disabled
3	2XTMR_EN	R/W	1b0	Enable 2X Safety Timer 1b0 = The timer is not slowed at any time 1b1 = The timer is slowed by 2x when in any control other than CC or CV
2-1	SAFETY_TIMER_LIMIT_1:0	R/W	2b01	Charger Safety Timer 2b00 = 3 Hr Fast Charge 2b01 = 6 Hr Fast Charge 2b10 = 12 Hr Fast Charge 2b11 = Disabled
0	RESERVED	R/W	1b0	Reserved

7.5.1.18 CHARGERCTRL1 Register (Address = 0x18) [reset = 0xC2]

CHARGERCTRL1 is shown in [Figure 7-33](#) and described in [Table 7-25](#).

Return to [Summary Table](#).

Figure 7-33. CHARGERCTRL1 Register

7	6	5	4	3	2	1	0
VINDPM_DIS	VINPDM_2:0			DPPM_DIS	THERM_REG_2:0		
R/W-1b1	R/W-3b100			R/W-1b0	R/W-3b010		

Table 7-25. CHARGERCTRL1 Register Field Descriptions

Bit	Field	Type	Reset	Description
7	VINDPM_DIS	R/W	1b1	Disable VINDPM Function 1b0 = VINDPM Enabled 1b1 = VINDPM Disabled
6-4	VINPDM_2:0	R/W	3b100	VINDPM Level Selection 3b000 = 4.2 V 3b001 = 4.3 V 3b010 = 4.4 V 3b011 = 4.5 V 3b100 = 4.6 V 3b101 = 4.7 V 3b110 = 4.8 V 3b111 = 4.9 V

Table 7-25. CHARGERCTRL1 Register Field Descriptions (continued)

Bit	Field	Type	Reset	Description
3	DPPM_DIS	R/W	1b0	DPPM Disable 1b0 = DPPM function enabled 1b1 = DPPM function disabled
2-0	THERM_REG_2:0	R/W	3b010	Thermal Charge Current Foldback Threshold 3b000 = 80°C 3b001 = 85°C 3b010 = 90°C 3b011 = 95°C 3b100 = 100°C 3b101 = 105°C 3b110 = 110°C 3b111 = Disabled

7.5.1.19 ILIMCTRL Register (Address = 0x19) [reset = 0x6]

ILIMCTRL is shown in [Figure 7-34](#) and described in [Table 7-26](#).

Return to [Summary Table](#).

Figure 7-34. ILIMCTRL Register

7	6	5	4	3	2	1	0
RESERVED						ILIM_2:0	
R/W-5b00000						R/W-3b110	

Table 7-26. ILIMCTRL Register Field Descriptions

Bit	Field	Type	Reset	Description
7-3	RESERVED	R/W	5b00000	Reserved
2-0	ILIM_2:0	R/W	3b110	Input Current Limit Level Selection 3b000 = 50 mA 3b001 = 100 mA 3b010 = 150 mA 3b011 = 200 mA 3b100 = 300 mA 3b101 = 400 mA 3b110 = 500 mA 3b111 = 600 mA

7.5.1.20 LDOCTRL Register (Address = 0x1D) [reset = 0xB0]

LDOCTRL is shown in [Figure 7-35](#) and described in [Table 7-27](#).

Return to [Summary Table](#).

Figure 7-35. LDOCTRL Register

7	6	5	4	3	2	1	0
EN_LS_LDO	VLDO_4:0					LDO_SWITCH_CONFIG	RESERVED
R/W-1b1	R/W-5b01100					R/W-1b0	R/W-1b0

Table 7-27. LDOCTRL Register Field Descriptions

Bit	Field	Type	Reset	Description
7	EN_LS_LDO	R/W	1b1	LS/LDO Enable 1b0 = Disable LS/LDO 1b1 = Enable LS/LDO
6-2	VLDO_4:0	R/W	5b01100	LDO output voltage setting (1.8 V default) LDO Voltage = 600 mV + VLDO Code x 100 mV
1	LDO_SWITCH_CONFIG	R/W	1b0	LDO / Load Switch Configuration Select 1b0 = LDO 1b1 = Load Switch
0	RESERVED	R/W	1b0	Reserved

7.5.1.21 MRCTRL Register (Address = 0x30) [reset = 0x2A]

MRCTRL is shown in [Figure 7-36](#) and described in [Table 7-28](#).

Return to [Summary Table](#).

Figure 7-36. MRCTRL Register

7	6	5	4	3	2	1	0
MR_RESET_VIN	MR_WAKE1_TIMER	MR_WAKE2_TIMER	MR_RESET_WARN_1:0		MR_HW_RESET_1:0		RESERVED
R/W-1b0	R/W-1b0	R/W-1b1	R/W-2b01		R/W-2b01		R/W-1b0

Table 7-28. MRCTRL Register Field Descriptions

Bit	Field	Type	Reset	Description
7	MR_RESET_VIN	R/W	1b0	VIN Power Good gated MR Reset Enable 1b0 = Reset sent when /MR reset time is met regardless of VIN state 1b1 = Reset sent when MR reset is met and Vin is valid
6	MR_WAKE1_TIMER	R/W	1b0	Wake 1 Timer setting 1b0 = 125 ms 1b1 = 500 ms
5	MR_WAKE2_TIMER	R/W	1b1	Wake 2 Timer setting 1b0 = 1 s 1b1 = 2 s
4-3	MR_RESET_WARN_1:0	R/W	2b01	MR Reset Warn Timer setting 2b00 = MR_HW_RESET - 0.5 s 2b01 = MR_HW_RESET - 1.0 s 2b10 = MR_HW_RESET - 1.5 s 2b11 = MR_HW_RESET - 2.0 s
2-1	MR_HW_RESET_1:0	R/W	2b01	MR HW Reset Timer setting 2b00 = 4 s 2b01 = 8 s 2b10 = 10 s 2b11 = 14 s
0	RESERVED	R/W	1b0	Reserved

7.5.1.22 ICCTRL0 Register (Address = 0x35) [reset = 0x10]

ICCTRL0 is shown in [Figure 7-37](#) and described in [Table 7-29](#).

Return to [Summary Table](#).

Figure 7-37. ICCTRL0 Register

7	6	5	4	3	2	1	0
EN_SHIP_MODE	RESERVED	AUTOWAKE_1:0		RESERVED	GLOBAL_INT_MASK	HW_RESET	SW_RESET
R/W-1b0	R/W-1b0	R/W-2b01		R/W-1b0	R/W-1b0	R/W-1b0	R/W-1b0

Table 7-29. ICCTRL0 Register Field Descriptions

Bit	Field	Type	Reset	Description
7	EN_SHIP_MODE	R/W	1b0	Ship Mode Enable 1b0 = Normal operation 1b1 = Enter Ship Mode when VIN is not valid and /MR is high
6	RESERVED	R/W	1b0	Reserved
5-4	AUTOWAKE_1:0	R/W	2b01	Auto-wakeup Timer (TRESTART) for /MR HW Reset 2b00 = 0.6 s 2b01 = 1.2 s 2b10 = 2.4 s 2b11 = 5 s
3	RESERVED	R/W	1b0	Reserved
2	GLOBAL_INT_MASK	R/W	1b0	Global Interrupt Mask 1b0 = Normal Operation 1b1 = Mask all interrupts
1	HW_RESET	R/W	1b0	HW Reset 1b0 = Normal operation 1b1 = HW Reset. Temporarily power down all power rails, except VDD. I ² C Register go to default settings.
0	SW_RESET	R/W	1b0	SW_Reset 1b0 = Normal operation 1b1 = SW Reset. I ² C Registers go to default settings.

7.5.1.23 ICCTRL1 Register (Address = 0x36) [reset = 0x0]

ICCTRL1 is shown in [Figure 7-38](#) and described in [Table 7-30](#).

Return to [Summary Table](#).

Figure 7-38. ICCTRL1 Register

7	6	5	4	3	2	1	0
MR_LPRESS_ACTION_1:0	RESERVED	RESERVED	PG_MODE_1:0		PMID_MODE_1:0		
R/W-2b00	R/W-1b0	R/W-1b0	R/W-2b00		R/W-2b00		

Table 7-30. ICCTRL1 Register Field Descriptions

Bit	Field	Type	Reset	Description
7-6	MR_LPRESS_ACTION_1:0	R/W	2b00	MR Long Press Action 2b00 = HW Reset (Power Cycle) 2b01 = Do nothing 2b10 = Enter Ship Mode 2b11 = Enter Ship Mode
5	RESERVED	R/W	1b0	Reserved
4	RESERVED	R/W	1b0	Reserved

Table 7-30. ICCTRL1 Register Field Descriptions (continued)

Bit	Field	Type	Reset	Description
3-2	PG_MODE_1:0	R/W	2b00	<p>$\overline{\text{PG}}$ Pin Mode of Operation</p> <p>2b00 = VIN Power Good. $\overline{\text{PG}}$ pulls to GND when $V_{\text{IN}} > V_{\text{UVLO}}$, $V_{\text{IN}} > V_{\text{BAT}} + V_{\text{SLP}}$ and $V_{\text{IN}} < V_{\text{IN_OVP}}$.</p> <p>2b01 = Deglitched Level Shifted /MR. $\overline{\text{PG}}$ is high impedance when the $\overline{\text{MR}}$ input is high, and $\overline{\text{PG}}$ pulls to GND when the $\overline{\text{MR}}$ input is low.</p> <p>2b1x = General Purpose Open Drain Output. The state of the $\overline{\text{PG}}$ pin is then controlled through the GPO_PG bit, where if GPO_PG is 0, the $\overline{\text{PG}}$ pin is pulled to GND and if it is 1, the $\overline{\text{PG}}$ pin is in high impedance.</p>
1-0	PMID_MODE_1:0	R/W	2b00	<p>PMID Control</p> <p>Sets how PMID is powered in any state, except Ship Mode.</p> <p>2b00 = PMID powered from BAT or VIN if present</p> <p>2b01 = PMID powered from BAT only, even if VIN is present</p> <p>2b10 = PMID disconnected and left floating</p> <p>2b11 = PMID disconnected and pulled down.</p>

7.5.1.24 ICCTRL2 Register (Address = 0x37) [reset = 0x40]

ICCTRL2 is shown in [Figure 7-39](#) and described in [Table 7-31](#).

Return to [Summary Table](#).

Figure 7-39. ICCTRL2 Register

7	6	5	4	3	2	1	0
PMID_REG_CTRL_2:0		GPO_PG		RESERVED		HWRESET_14 S_WD	CHARGER_DIS ABLE
R/W-3b010		R/W-1b0		R/W-2b00		R/W-1b0	R/W-1b0

Table 7-31. ICCTRL2 Register Field Descriptions

Bit	Field	Type	Reset	Description
7-5	PMID_REG_CTRL_2:0	R/W	3b010	<p>System (PMID) Regulation Voltage</p> <p>3b000 = Battery Tracking</p> <p>3b001 = 4.4 V</p> <p>3b010 = 4.5 V</p> <p>3b011 = 4.6 V</p> <p>3b100 = 4.7 V</p> <p>3b101 = 4.8 V</p> <p>3b110 = 4.9 V</p> <p>3b111 = Pass-Through (V_{IN})</p>
4	GPO_PG	R/W	1b0	<p>/PG General Purpose Output State Control</p> <p>1b0 = Pulled Down</p> <p>1b1 = High Z</p>
3-2	RESERVED	R/W	2b00	Reserved
1	HWRESET_14S_WD	R/W	1b0	<p>Enable for 14-second I²C watchdog timer for HW Reset after VIN connection</p> <p>1b0 = Timer disabled</p> <p>1b1 = Device will perform HW reset if no I²C transaction is done within 14 s after VIN is present</p>
0	CHARGER_DISABLE	R/W	1b0	<p>Charge Disable</p> <p>1b0 = Charge enabled if /CE pin is low</p> <p>1b1 = Charge disabled</p>

7.5.1.25 TS_FASTCHGCTRL Register (Address = 0x61) [reset = 0x34]

TS_FASTCHGCTRL is shown in [Figure 7-40](#) and described in [Table 7-32](#).

Return to [Summary Table](#).

Figure 7-40. TS_FASTCHGCTRL Register

7	6	5	4	3	2	1	0
RESERVED	TS_VBAT_REG_2:0			RESERVED	TS_ICHRG_2:0		
R/W-1b0	R/W-3b011			R/W-1b0	R/W-3b100		

Table 7-32. TS_FASTCHGCTRL Register Field Descriptions

Bit	Field	Type	Reset	Description
7	RESERVED	R/W	1b0	Reserved
6-4	TS_VBAT_REG_2:0	R/W	3b011	Reduced target battery voltage during Warm 3b000 = No reduction 3b001 = VBAT_REG - 50 mV 3b010 = VBAT_REG - 100 mV 3b011 = VBAT_REG - 150 mV 3b100 = VBAT_REG - 200 mV 3b101 = VBAT_REG - 250 mV 3b110 = VBAT_REG - 300 mV 3b111 = VBAT_REG - 350 mV
3	RESERVED	R/W	1b0	Reserved
2-0	TS_ICHRG_2:0	R/W	3b100	Fast charge current when decreased by TS function 3b000 = No reduction 3b001 = 0.875 x ICHG 3b010 = 0.750 x ICHG 3b011 = 0.625 x ICHG 3b100 = 0.500 x ICHG 3b101 = 0.375 x ICHG 3b110 = 0.250 x ICHG 3b111 = 0.125 x ICHG

7.5.1.26 TS_COLD Register (Address = 0x62) [reset = 0x7C]

TS_COLD is shown in [Figure 7-41](#) and described in [Table 7-33](#).

Return to [Summary Table](#).

Figure 7-41. TS_COLD Register

7	6	5	4	3	2	1	0
TS_COLD_7:0							
R/W-8b01111100							

Table 7-33. TS_COLD Register Field Descriptions

Bit	Field	Type	Reset	Description
7-0	TS_COLD_7:0	R/W	8b01111100	TS Cold Threshold 1b = 4.688 mV 10b = 9.375 mV 100b = 18.75 mV 1000b = 37.5 mV 10000b = 75 mV 100000b = 150 mV 1000000b = 300 mV 10000000b = 600 mV

7.5.1.27 TS_COOL Register (Address = 0x63) [reset = 0x6D]

TS_COOL is shown in [Figure 7-42](#) and described in [Table 7-34](#).

Return to [Summary Table](#).

Figure 7-42. TS_COOL Register

7	6	5	4	3	2	1	0
TS_COOL_7:0							
R/W-8b01101101							

Table 7-34. TS_COOL Register Field Descriptions

Bit	Field	Type	Reset	Description
7-0	TS_COOL_7:0	R/W	8b01101101	TS Cool Threshold 1b = 4.688 mV 10b = 9.375 mV 100b = 18.75 mV 1000b = 37.5 mV 10000b = 75 mV 100000b = 150 mV 1000000b = 300 mV 10000000b = 600 mV

7.5.1.28 TS_WARM Register (Address = 0x64) [reset = 0x38]

TS_WARM is shown in [Figure 7-43](#) and described in [Table 7-35](#).

Return to [Summary Table](#).

Figure 7-43. TS_WARM Register

7	6	5	4	3	2	1	0
TS_WARM_7:0							
R/W-8b00111000							

Table 7-35. TS_WARM Register Field Descriptions

Bit	Field	Type	Reset	Description
7-0	TS_WARM_7:0	R/W	8b00111000	TS Warm Threshold 1b = 4.688 mV 10b = 9.375 mV 100b = 18.75 mV 1000b = 37.5 mV 10000b = 75 mV 100000b = 150 mV 1000000b = 300 mV 10000000b = 600 mV

7.5.1.29 TS_HOT Register (Address = 0x65) [reset = 0x27]

TS_HOT is shown in [Figure 7-44](#) and described in [Table 7-36](#).

Return to [Summary Table](#).

Figure 7-44. TS_HOT Register

7	6	5	4	3	2	1	0
TS_HOT_7:0							
R/W-8b00100111							

Table 7-36. TS_HOT Register Field Descriptions

Bit	Field	Type	Reset	Description
7-0	TS_HOT_7:0	R/W	8b00100111	TS Hot Threshold 1b = 4.688 mV 10b = 9.375 mV 100b = 18.75 mV 1000b = 37.5 mV 10000b = 75 mV 100000b = 150 mV 1000000b = 300 mV 10000000b = 600 mV

7.5.1.30 DEVICE_ID Register (Address = 0x6F) [reset = 0x3A]

DEVICE_ID is shown in [Figure 7-45](#) and described in [Table 7-37](#).

Return to [Summary Table](#).

Figure 7-45. DEVICE_ID Register

7	6	5	4	3	2	1	0
DEVICE_ID_7:0							
R-8b00111010							

Table 7-37. DEVICE_ID Register Field Descriptions

Bit	Field	Type	Reset	Description
7-0	DEVICE_ID_7:0	R	8b00111010	Device ID 00111010b = BQ21061

8 Application and Implementation

Note

Information in the following applications sections is not part of the TI component specification, and TI does not warrant its accuracy or completeness. TI's customers are responsible for determining suitability of components for their purposes, as well as validating and testing their design implementation to confirm system functionality.

8.1 Application Information

A typical application of the BQ21061 consists of the device configured as an I²C controlled single cell Li-ion battery charger and power path manager or small battery applications such as smart-watches and wireless headsets. A battery thermistor may be connected to the TS pin to allow the device to monitor the battery temperature and control charging as desired.

The system designer may connect the $\overline{\text{MR}}$ input to a push-button to send interrupts to the host as the button is pressed or to allow the application's end user to reset the system. If not used this pin must be left floating or tied to BAT.

8.2 Typical Application

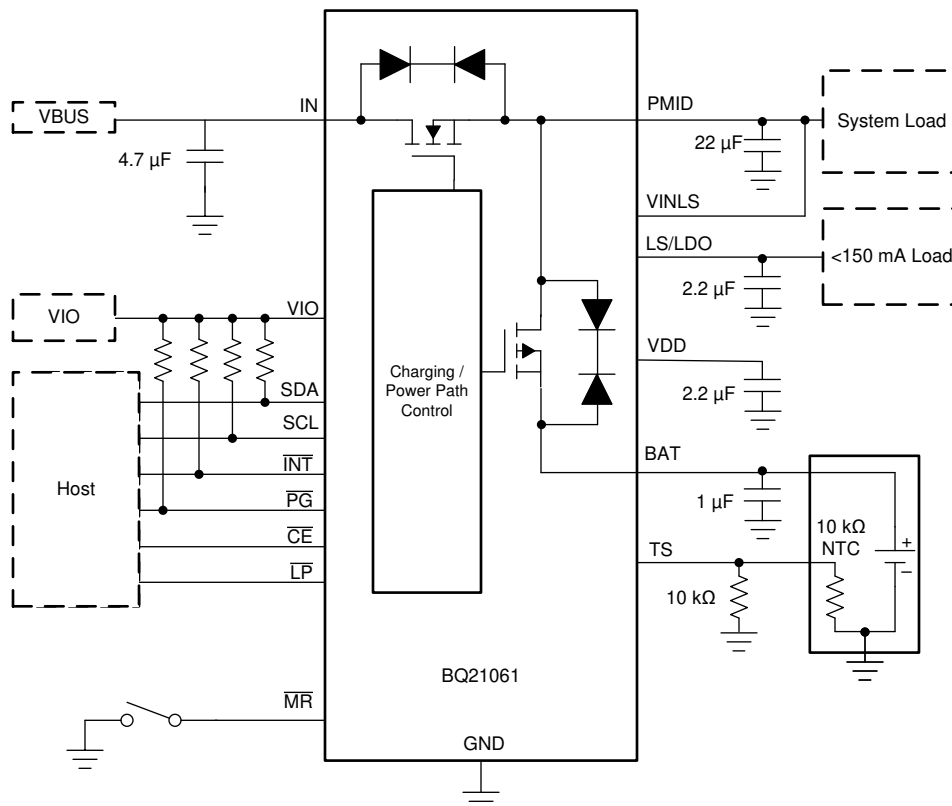

Figure 8-1. Typical Application Diagram

8.2.1 Design Requirements

The design parameters for the following design example are shown in [Table 8-1](#) below.

Table 8-1. Design Parameters

PARAMETER	VALUE
IN Supply Voltage	5 V
Battery Regulation Voltage	4.2 V
LDO Output Voltage	LDO (1.8 V)

8.2.2 Detailed Design Procedure

8.2.2.1 Input (IN/PMID) Capacitors

Low ESR ceramic capacitors such as X7R or X5R is preferred for input decoupling capacitors and should be placed as close as possible to the supply and ground pins for the IC. Due to the voltage derating of the capacitors it is recommended that 25-V rated capacitors are used for IN and PMID pins which can normally operate at 5 V. After derating the minimum capacitance must be higher than 1 μ F.

8.2.2.2 VDD, LDO Input and Output Capacitors

A Low ESR ceramic capacitor such as X7R or X5R is recommended for the LDO decoupling capacitor. A 4.7- μ F capacitor is recommended for VDD output. For the LDO output a 2.2- μ F capacitor is recommended. The minimum supported capacitance after derating must be higher than 1 μ F to ensure stability. The VINLS input bypass capacitor value should match or exceed the LDO output capacitor value.

8.2.2.3 TS

A 10-k Ω NTC should be connected in parallel to a 10-k Ω biasing resistor connected to ground. The ground connection of both the NTC and biasing resistor must be done as close as possible to the GND pin of the device or kelvin connected to it to minimize any error in TS measurement due to IR drops on the board ground lines.

If the system designer does not wish to use the TS function for charging control, a 5-k Ω resistor from TS to ground must be connected.

8.2.2.4 Recommended Passive Components

Table 8-2. Recommended Passive Components

		MIN	NOM	MAX	UNIT
C _{PMID}	Capacitance in PMID pin	1 ⁽¹⁾	22	47	μ F
C _{LDO}	LDO output capacitance	1	2.2	4.7	μ F
C _{VDD}	VDD output capacitance	1	2.2	4.7	μ F
C _{BAT}	BAT pin capacitance	1		–	μ F
C _{IN}	IN input bypass capacitance	1	4.7	10	μ F
C _{INLS}	VINLS input bypass capacitance	1		–	μ F
C _{TS}	Capacitance from TS pin to ground	0	0	1	nF

(1) For PMID regulation loop stability, for better transient performance a minimum capacitance (after derating) of 10 μ F is recommended.

8.2.3 Application Curves

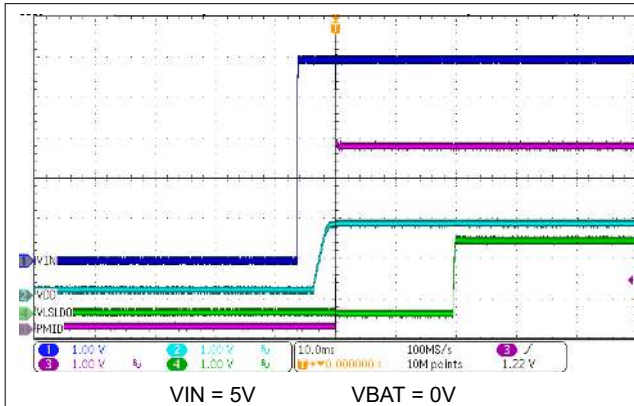

Figure 8-2. Power Up from IN Supply Insertion with No Battery

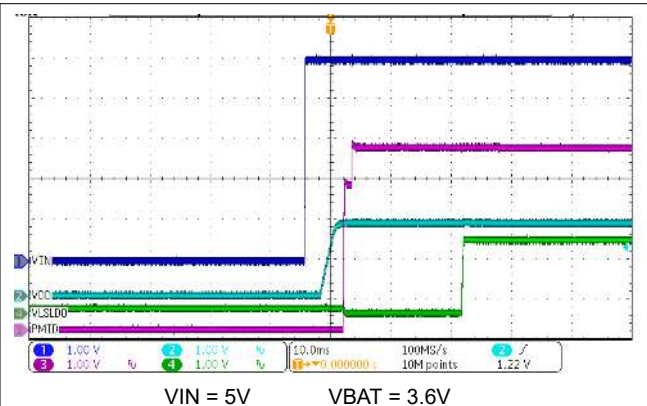

Figure 8-3. Power Up from Ship Mode with IN Supply Insertion

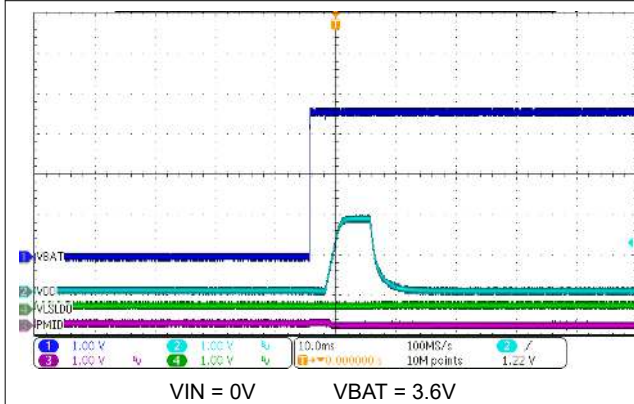

Figure 8-4. Wake In To Ship Mode on Battery Insertion with No IN Supply

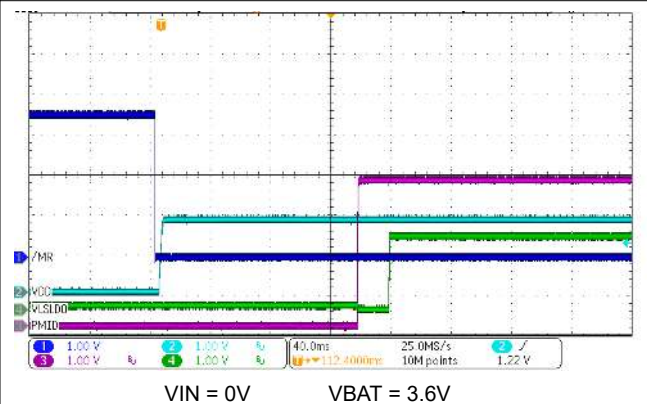

Figure 8-5. Power Up from Ship Mode with \overline{MR} Press

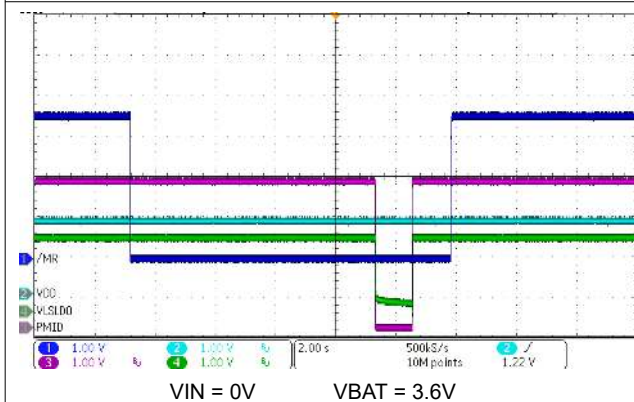

Figure 8-6. HW Reset on \overline{MR} Long Button Press

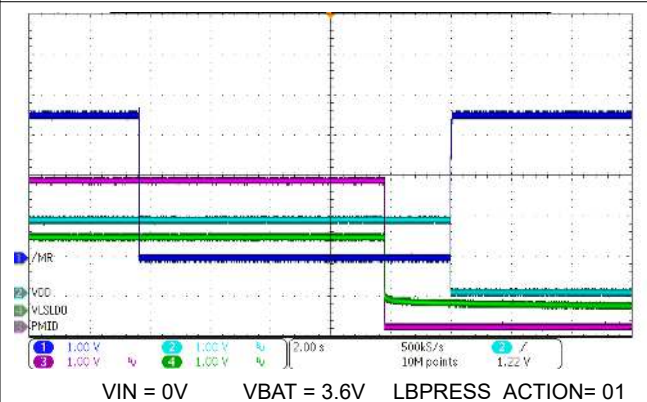

Figure 8-7. Ship Mode Entry with \overline{MR} Long Button Press

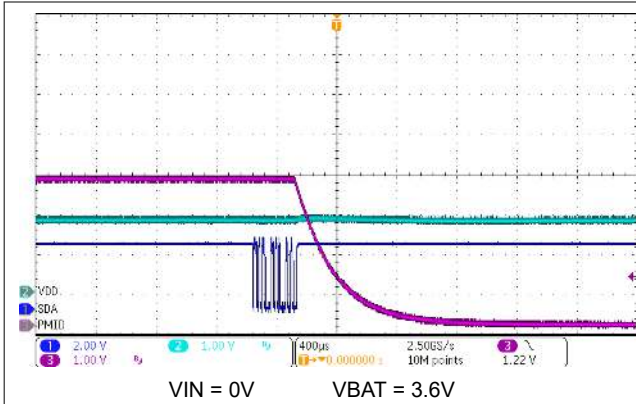

Figure 8-8. HW Reset Through I²C Command

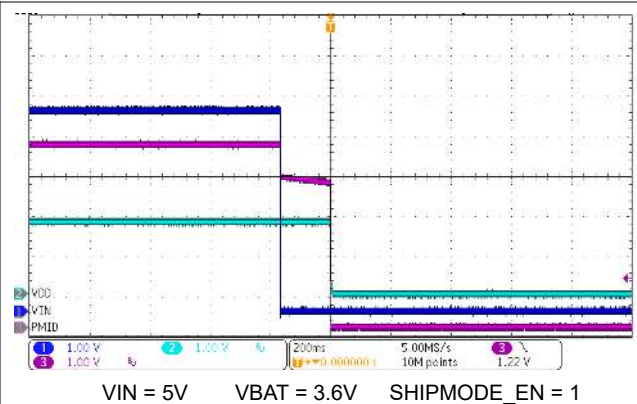

Figure 8-9. Ship Mode Entry on IN Supply Removal

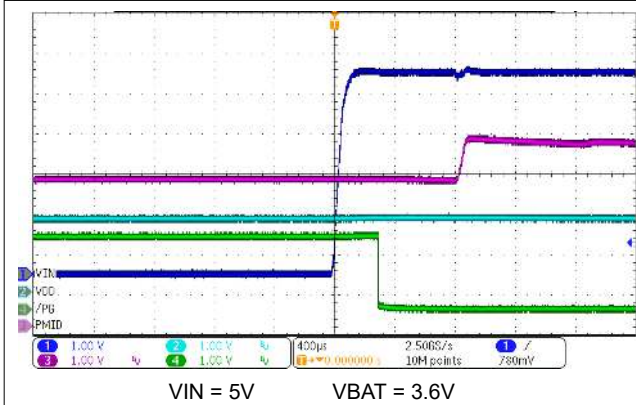

Figure 8-10. $\overline{\text{PG}}$ Power Good Function - IN Supply Insertion

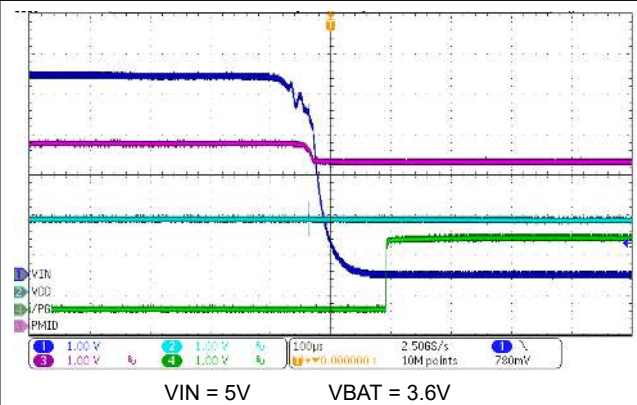

Figure 8-11. $\overline{\text{PG}}$ Power Good Function - IN Supply Removal

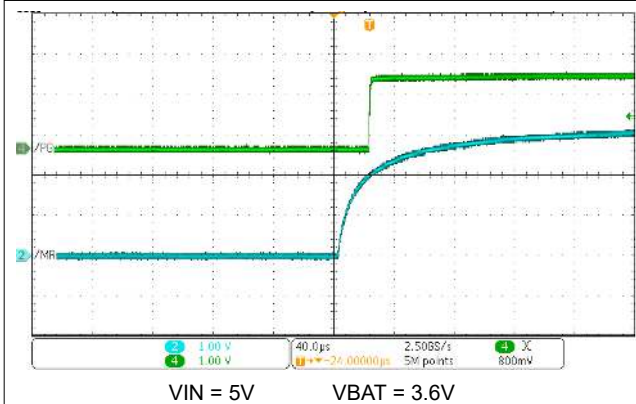

Figure 8-12. $\overline{\text{PG}}$ $\overline{\text{MR}}$ Level Shift Function - $\overline{\text{MR}}$ Rising

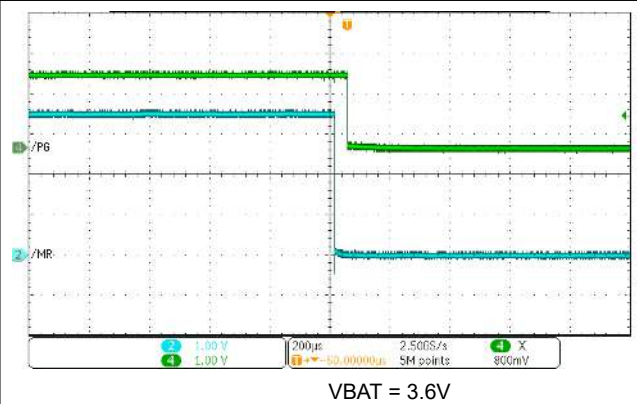

Figure 8-13. $\overline{\text{PG}}$ $\overline{\text{MR}}$ Level Shift Function - $\overline{\text{MR}}$ Falling

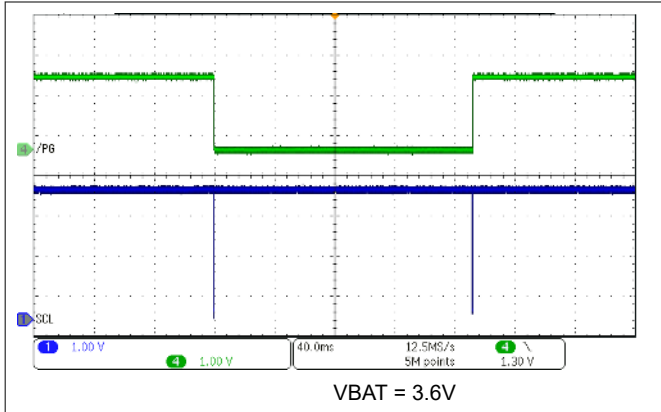

Figure 8-14. PG General Purpose Output Function - GPO_PG Bit Toggle

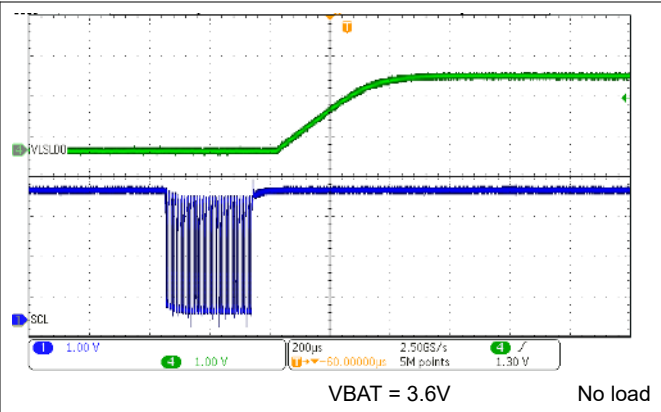

Figure 8-15. LDO Enable Through I2C (EN_LS_LDO)

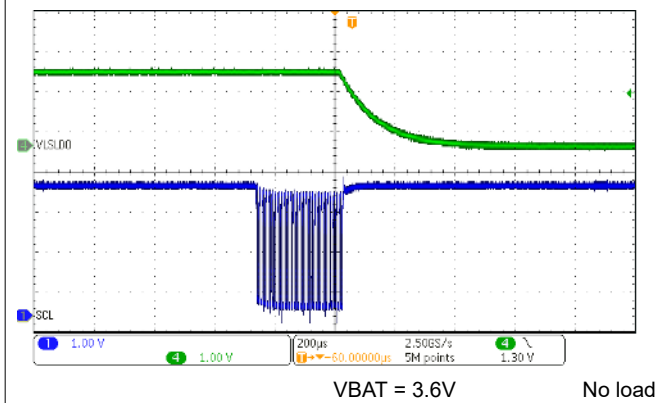

Figure 8-16. LDO Disable Through I2C (EN_LS_LDO)

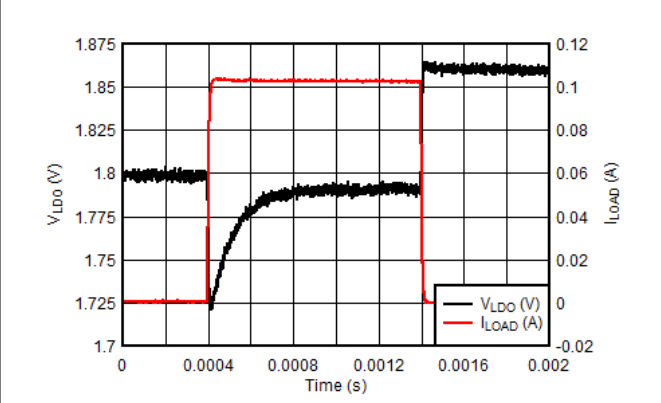

Figure 8-17. LDO Load Transient - VLDO = 1.8V

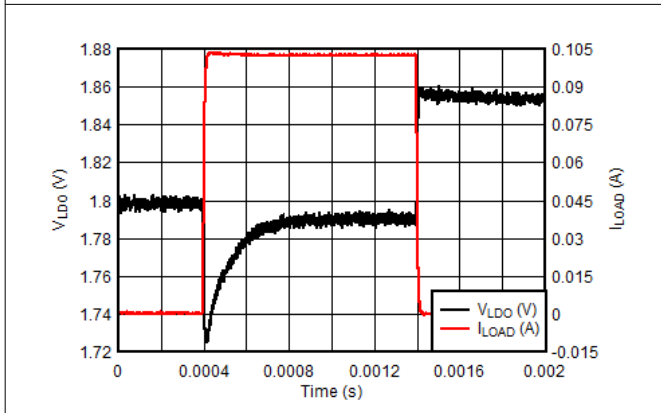

Figure 8-18. LDO Load Transient - VLDO = 1.8V

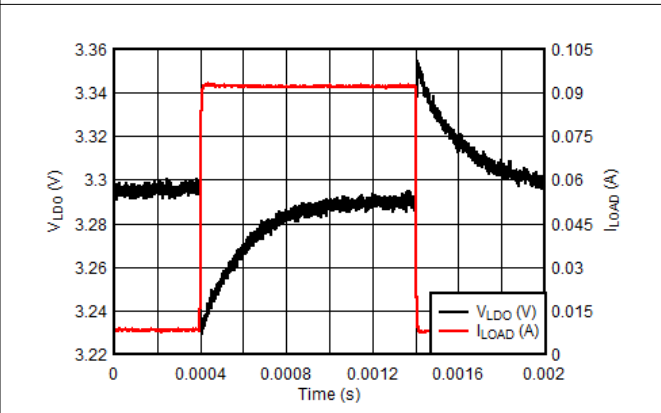

Figure 8-19. LDO Load Transient - VLDO = 3.3V

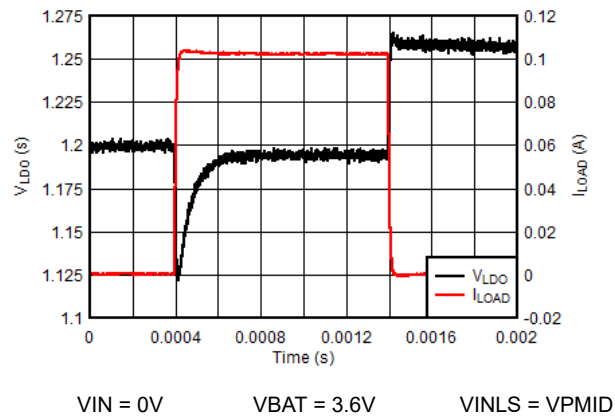

Figure 8-20. LDO Load Transient - VLDO = 1.2V

9 Power Supply Recommendations

The BQ21061 requires the adapter or IN supply to be between 3.4 V and 5.5 V with at least 600-mA rating. The battery voltage must be higher than 2.4 V or $V_{BATUVLO}$ to ensure proper operation.

10 Layout

10.1 Layout Guidelines

- Have solid ground plane that is tied to the GND bump
- Place LDO and VDD output capacitors as close as possible to the respective bumps and GND or ground plane with short copper trace connection
- Place PMID capacitor as close to the PMID bump as possible and GND or ground plane.

10.2 Layout Example

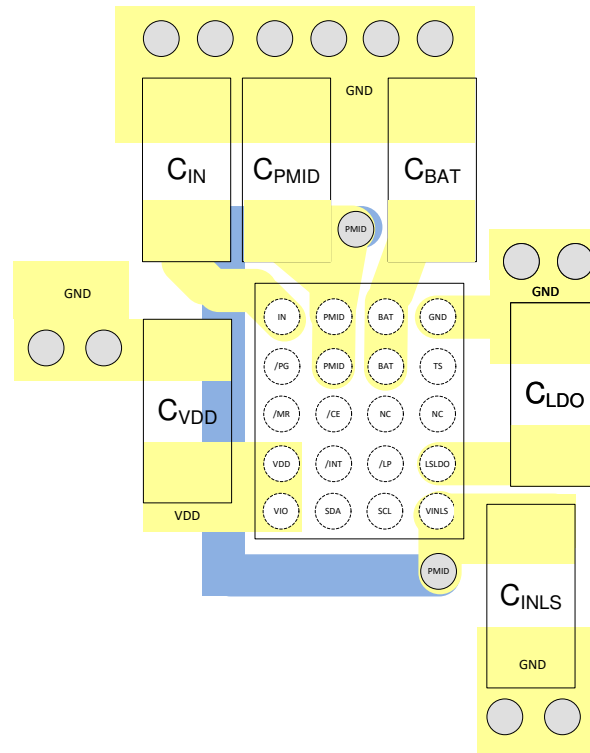

Figure 10-1. Layout Example

11 Device and Documentation Support

11.1 Device Support

11.1.1 Third-Party Products Disclaimer

TI'S PUBLICATION OF INFORMATION REGARDING THIRD-PARTY PRODUCTS OR SERVICES DOES NOT CONSTITUTE AN ENDORSEMENT REGARDING THE SUITABILITY OF SUCH PRODUCTS OR SERVICES OR A WARRANTY, REPRESENTATION OR ENDORSEMENT OF SUCH PRODUCTS OR SERVICES, EITHER ALONE OR IN COMBINATION WITH ANY TI PRODUCT OR SERVICE.

11.2 Documentation Support

11.2.1 Related Documentation

For related documentation see the following: [BQ21061EVM User's Guide](#) and [BQ21061 Setup Guide Tool](#)

11.3 Receiving Notification of Documentation Updates

To receive notification of documentation updates, navigate to the device product folder on [ti.com](#). Click on *Subscribe to updates* to register and receive a weekly digest of any product information that has changed. For change details, review the revision history included in any revised document.

11.4 Support Resources

[TI E2E™ support forums](#) are an engineer's go-to source for fast, verified answers and design help — straight from the experts. Search existing answers or ask your own question to get the quick design help you need.

Linked content is provided "AS IS" by the respective contributors. They do not constitute TI specifications and do not necessarily reflect TI's views; see TI's [Terms of Use](#).

11.5 Electrostatic Discharge Caution



This integrated circuit can be damaged by ESD. Texas Instruments recommends that all integrated circuits be handled with appropriate precautions. Failure to observe proper handling and installation procedures can cause damage.

ESD damage can range from subtle performance degradation to complete device failure. Precision integrated circuits may be more susceptible to damage because very small parametric changes could cause the device not to meet its published specifications.

11.6 Trademarks

TI E2E™ is a trademark of Texas Instruments.

All trademarks are the property of their respective owners.

11.7 Glossary

[TI Glossary](#) This glossary lists and explains terms, acronyms, and definitions.

12 Mechanical, Packaging, and Orderable Information

The following pages include mechanical, packaging, and orderable information. This information is the most current data available for the designated devices. This data is subject to change without notice and revision of this document. For browser-based versions of this data sheet, refer to the left-hand navigation.

PACKAGING INFORMATION

Orderable Device	Status (1)	Package Type	Package Drawing	Pins	Package Qty	Eco Plan (2)	Lead finish/ Ball material (6)	MSL Peak Temp (3)	Op Temp (°C)	Device Marking (4/5)	Samples
BQ21061YFPR	ACTIVE	DSBGA	YFP	20	3000	RoHS & Green	SNAGCU	Level-1-260C-UNLIM	-40 to 85	BQ21061	Samples
BQ21061YFPT	ACTIVE	DSBGA	YFP	20	250	RoHS & Green	SNAGCU	Level-1-260C-UNLIM	-40 to 85	BQ21061	Samples

(1) The marketing status values are defined as follows:

ACTIVE: Product device recommended for new designs.

LIFEBUY: TI has announced that the device will be discontinued, and a lifetime-buy period is in effect.

NRND: Not recommended for new designs. Device is in production to support existing customers, but TI does not recommend using this part in a new design.

PREVIEW: Device has been announced but is not in production. Samples may or may not be available.

OBSOLETE: TI has discontinued the production of the device.

(2) **RoHS:** TI defines "RoHS" to mean semiconductor products that are compliant with the current EU RoHS requirements for all 10 RoHS substances, including the requirement that RoHS substance do not exceed 0.1% by weight in homogeneous materials. Where designed to be soldered at high temperatures, "RoHS" products are suitable for use in specified lead-free processes. TI may reference these types of products as "Pb-Free".

RoHS Exempt: TI defines "RoHS Exempt" to mean products that contain lead but are compliant with EU RoHS pursuant to a specific EU RoHS exemption.

Green: TI defines "Green" to mean the content of Chlorine (Cl) and Bromine (Br) based flame retardants meet JS709B low halogen requirements of <=1000ppm threshold. Antimony trioxide based flame retardants must also meet the <=1000ppm threshold requirement.

(3) MSL, Peak Temp. - The Moisture Sensitivity Level rating according to the JEDEC industry standard classifications, and peak solder temperature.

(4) There may be additional marking, which relates to the logo, the lot trace code information, or the environmental category on the device.

(5) Multiple Device Markings will be inside parentheses. Only one Device Marking contained in parentheses and separated by a "~" will appear on a device. If a line is indented then it is a continuation of the previous line and the two combined represent the entire Device Marking for that device.

(6) Lead finish/Ball material - Orderable Devices may have multiple material finish options. Finish options are separated by a vertical ruled line. Lead finish/Ball material values may wrap to two lines if the finish value exceeds the maximum column width.

Important Information and Disclaimer:The information provided on this page represents TI's knowledge and belief as of the date that it is provided. TI bases its knowledge and belief on information provided by third parties, and makes no representation or warranty as to the accuracy of such information. Efforts are underway to better integrate information from third parties. TI has taken and continues to take reasonable steps to provide representative and accurate information but may not have conducted destructive testing or chemical analysis on incoming materials and chemicals. TI and TI suppliers consider certain information to be proprietary, and thus CAS numbers and other limited information may not be available for release.

In no event shall TI's liability arising out of such information exceed the total purchase price of the TI part(s) at issue in this document sold by TI to Customer on an annual basis.

TAPE AND REEL INFORMATION

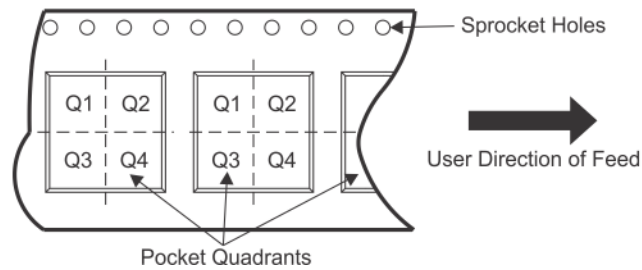
QUADRANT ASSIGNMENTS FOR PIN 1 ORIENTATION IN TAPE

*All dimensions are nominal

Device	Package Type	Package Drawing	Pins	SPQ	Reel Diameter (mm)	Reel Width W1 (mm)	A0 (mm)	B0 (mm)	K0 (mm)	P1 (mm)	W (mm)	Pin1 Quadrant
BQ21061YFPR	DSBGA	YFP	20	3000	180.0	8.4	1.77	2.17	0.62	4.0	8.0	Q1
BQ21061YFPT	DSBGA	YFP	20	250	180.0	8.4	1.77	2.17	0.62	4.0	8.0	Q1

TAPE AND REEL BOX DIMENSIONS

*All dimensions are nominal

Device	Package Type	Package Drawing	Pins	SPQ	Length (mm)	Width (mm)	Height (mm)
BQ21061YFPR	DSBGA	YFP	20	3000	182.0	182.0	20.0
BQ21061YFPT	DSBGA	YFP	20	250	182.0	182.0	20.0

YFP0020

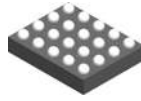

PACKAGE OUTLINE

DSBGA - 0.5 mm max height

DIE SIZE BALL GRID ARRAY

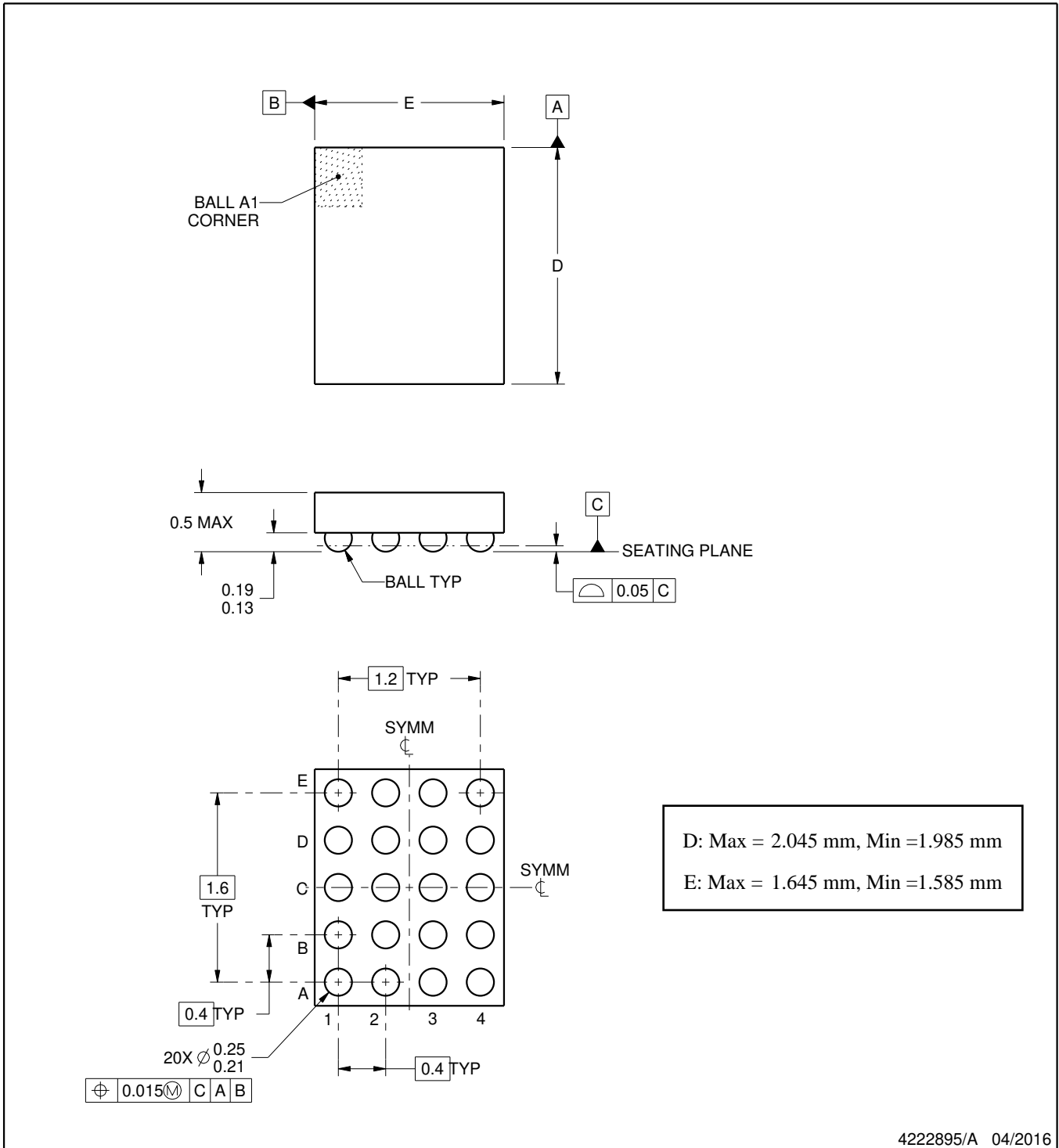

4222895/A 04/2016

NOTES:

1. All linear dimensions are in millimeters. Any dimensions in parenthesis are for reference only. Dimensioning and tolerancing per ASME Y14.5M.
2. This drawing is subject to change without notice.

EXAMPLE BOARD LAYOUT

YFP0020

DSBGA - 0.5 mm max height

DIE SIZE BALL GRID ARRAY

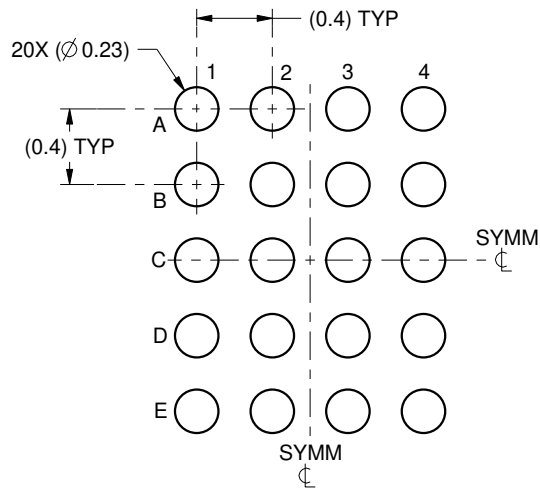

LAND PATTERN EXAMPLE
SCALE:25X

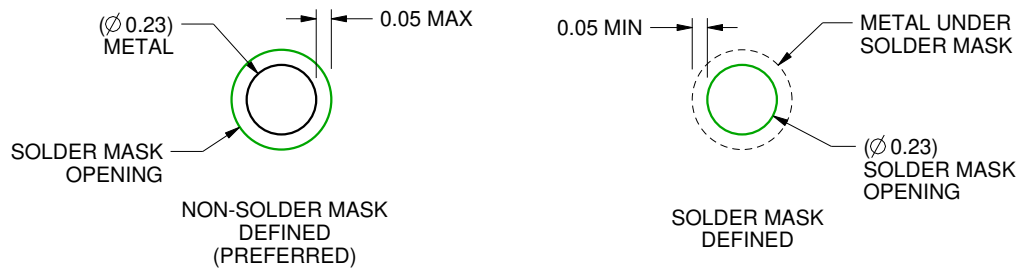

SOLDER MASK DETAILS
NOT TO SCALE

4222895/A 04/2016

NOTES: (continued)

- Final dimensions may vary due to manufacturing tolerance considerations and also routing constraints. For more information, see Texas Instruments literature number SNVA009 (www.ti.com/lit/snva009).

EXAMPLE STENCIL DESIGN

YFP0020

DSBGA - 0.5 mm max height

DIE SIZE BALL GRID ARRAY

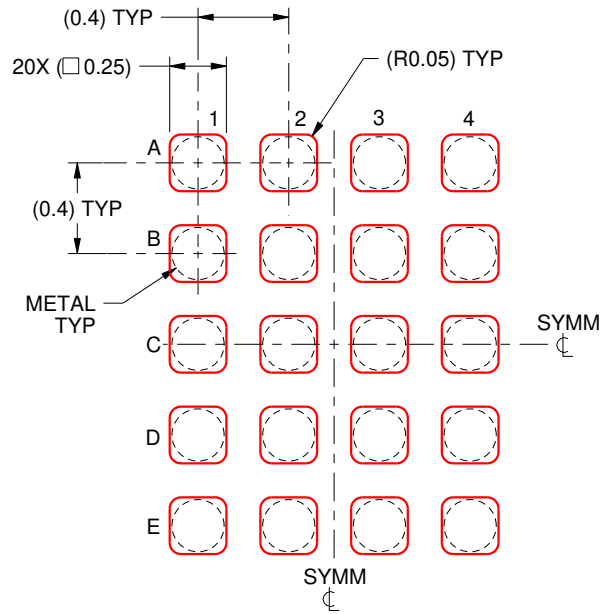

SOLDER PASTE EXAMPLE
BASED ON 0.1 mm THICK STENCIL
SCALE:30X

4222895/A 04/2016

NOTES: (continued)

4. Laser cutting apertures with trapezoidal walls and rounded corners may offer better paste release.

IMPORTANT NOTICE AND DISCLAIMER

TI PROVIDES TECHNICAL AND RELIABILITY DATA (INCLUDING DATA SHEETS), DESIGN RESOURCES (INCLUDING REFERENCE DESIGNS), APPLICATION OR OTHER DESIGN ADVICE, WEB TOOLS, SAFETY INFORMATION, AND OTHER RESOURCES "AS IS" AND WITH ALL FAULTS, AND DISCLAIMS ALL WARRANTIES, EXPRESS AND IMPLIED, INCLUDING WITHOUT LIMITATION ANY IMPLIED WARRANTIES OF MERCHANTABILITY, FITNESS FOR A PARTICULAR PURPOSE OR NON-INFRINGEMENT OF THIRD PARTY INTELLECTUAL PROPERTY RIGHTS.

These resources are intended for skilled developers designing with TI products. You are solely responsible for (1) selecting the appropriate TI products for your application, (2) designing, validating and testing your application, and (3) ensuring your application meets applicable standards, and any other safety, security, regulatory or other requirements.

These resources are subject to change without notice. TI grants you permission to use these resources only for development of an application that uses the TI products described in the resource. Other reproduction and display of these resources is prohibited. No license is granted to any other TI intellectual property right or to any third party intellectual property right. TI disclaims responsibility for, and you will fully indemnify TI and its representatives against, any claims, damages, costs, losses, and liabilities arising out of your use of these resources.

TI's products are provided subject to [TI's Terms of Sale](#) or other applicable terms available either on [ti.com](https://www.ti.com) or provided in conjunction with such TI products. TI's provision of these resources does not expand or otherwise alter TI's applicable warranties or warranty disclaimers for TI products.

TI objects to and rejects any additional or different terms you may have proposed.

Mailing Address: Texas Instruments, Post Office Box 655303, Dallas, Texas 75265
Copyright © 2023, Texas Instruments Incorporated