

# Bridgelux ES Array Series

## Product Data Sheet

### Introduction

The Bridgelux family of LED Array products delivers high performance, compact and cost-effective solid-state lighting solutions to serve the general lighting market. These products combine the higher efficacy, lifetime, and reliability benefits of LEDs with the light output levels of many conventional lighting sources. The Bridgelux ES Array Series has been specified to enable lamp and luminaire designs surpassing efficacy and quality of light requirements driven by regulatory standards with reasonable system design margins, enabling lighting product compliance to Energy Star, Title 24, Part L and other global standards.

The Bridgelux ES Array products provide a high performance alternative to conventional solid state solutions, delivering between 400 and 2000 lumens under application conditions in warm, neutral and cool white color temperatures. These compact high flux density light sources deliver uniform high quality illumination without pixilation or the multiple shadow effect caused by LED component based solutions. To simplify system design for appropriate light output, Bridgelux LED Arrays are specified to deliver performance under typical use conditions.

These integrated plug and play solutions reduce system complexity and enable miniaturized cost-effective lamp and luminaire designs. Lighting system designs incorporating these LED Arrays deliver comparable performance to that of 20-100 Watt incandescent and halogen, 7-42 Watt compact fluorescent, and 18-50 Watt HID based luminaires and feature increased system level efficacy and service life. Typical applications include replacement lamps, task, accent, spot, retail, track, down light, low bay, wide area, security, wall pack and street lighting.

### Features

- Compact high flux density light source
- Uniform high quality illumination
- Streamlined thermal path
- Energy Star / ANSI compliant binning structure
- More energy efficient than incandescent, halogen and fluorescent lamps
- Low voltage DC operation
- Instant light with unlimited dimming
- Long operating life
- RoHS compliant and Pb free

### Benefits

- Enhanced optical control
- Clean white light without pixilation
- Significantly reduced thermal resistance and increased operating temperatures
- Uniform consistent white light
- Lower operating costs
- Increased safety
- Easy to use with daylight and motion detectors to enable increased energy savings
- Reduced maintenance costs
- Environmentally friendly, no disposal issues

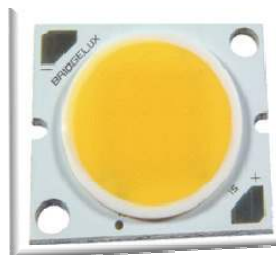

---

Table of Contents	Page
Product Nomenclature	3
Average Lumen Maintenance Characteristics	3
Environmental Compliance	3
UL Recognition	4
Minor Product Change Policy	4
Cautionary Statements	4
Case Temperature Measurement Point	5
Flux Characteristics	6
Optical Characteristics	7
Electrical Characteristics	8
Absolute Minimum and Maximum Ratings	9
Typical Performance at Alternative Drive Currents	10
Mechanical Dimensions	13
Typical Radiation Pattern	15
Wavelength Characteristics at Rated Test Current, $T_j=25^{\circ}\text{C}$	16
Typical Relative Luminous Flux vs. Current, $T_j=25^{\circ}\text{C}$	18
Typical Light Output Characteristics vs. Temperature	20
Typical Chromaticity Characteristics vs. Temperature	21
Typical Forward Current Characteristics at $T_j = 25^{\circ}\text{C}$	22
Current Derating Curves	27
Product Binning	32
Luminous Flux Binning Information	32
Color Binning Information	33
Mechanical Assembly and Handling	36
Product Packaging and Labeling	37
Packaging Tube Design	40
Design Resources	41

---

## Product Nomenclature

The part number designation for Bridgelux LED Arrays is explained as follows:

B X R A – A B C D E – R R R R R

Where:

B X R A – designates product family

A – designates color, C for Cool White, N for Neutral White and W for Warm White

B C – designates LED Array product flux, 04 for a 400 lumen array, 08 for a 800 lumen array, 12 for a 1200 lumen array, and 20 for a 2000 lumen array

D E – designates product family

R R R R R – used to designate product options, 00000 by default

The base product part number (BXRA-ABCDE) is indicated on each individual unit, printed on the bottom of the LED Array.

## Average Lumen Maintenance Characteristics

Bridgelux projects that its family of LED Array products will deliver, on average, greater than 70% lumen maintenance after 50,000 hours of operation at the rated forward test current. This performance assumes constant current operation with case temperature maintained at or below 70°C. For use beyond these typical operating conditions please consult your Bridgelux sales representative for further assistance.

These projections are based on a combination of package test data, semiconductor chip reliability data, a fundamental understanding of package related degradation mechanisms, and performance observed from products installed in the field using Bridgelux die technology. Bridgelux conducts lumen maintenance tests per LM80. Observation of design limits is required in order to achieve this projected lumen maintenance.

## Environmental Compliance

Bridgelux is committed to providing environmentally friendly products to the solid-state lighting market. Bridgelux LED Arrays are compliant to the European Union directives on the restriction of hazardous substances in electronic equipment, namely the RoHS directive. Bridgelux will not intentionally add the following restricted materials to LED Array products: lead, mercury, cadmium, hexavalent chromium, polybrominated biphenyls (PBB) or polybrominated diphenyl ethers (PBDE).

---

## UL Recognition

Bridgelux product became UL Recognized on 31 March, 2010. Please refer to the UL file E333389. Bridgelux uses UL Recognized materials with suitable flammability ratings in the LED Array to streamline the process for customers to secure UL listing of the final luminaire product. Bridgelux recommends that luminaires are designed with a Class 2 Driver to facilitate the UL listing process.

## Minor Product Change Policy

The rigorous qualification testing on products offered by Bridgelux provides performance assurance. Slight cosmetic changes that do not affect form, fit, or function may occur as Bridgelux continues product optimization.

## Cautionary Statements

### CAUTION: CONTACT WITH OPTICAL AREA

Contact with the resin area should be avoided. Applying stress to the resin area can result in damage to the product.

### CAUTION: EYE SAFETY

Eye safety classification for the use of Bridgelux LED Arrays is contained in the CIE S 009/E2002 Photobiological Safety of Lamps and Lamp Systems specification. Bridgelux LED Arrays are classified under section 6 lamp classification as Risk Group 2 (Moderate Risk). Please use appropriate precautions. It is important that employees working with LEDs are trained to use them safely. Luminaire manufacturers should refer to CIE S 009/E2002 to establish the classification of their product.

### CAUTION: RISK OF BURN

Do not touch the LED Array or resin area during operation. Allow the LED Array to cool for a sufficient period of time before handling. The LED Array may reach elevated temperatures such that it can burn skin when touched.

---

## Case Temperature Measurement Point

A case temperature measurement point location is included on the top surface of the Bridgelux LED Arrays. The location of this measurement point is indicated in the mechanical dimensions section of this data sheet.

The purpose of this measurement point is to allow the user access to a measurement point closely linked to the true case temperature on the back surface of the LED Array. Once the LED Array is installed, it is challenging to measure the back surface of the array, or true case temperature. Measuring the top surface of the product can lead to inaccurate results due to the poor thermal conductivity of the top layers of the array such as the solder mask and other materials.

Bridgelux has provided the case temperature measurement location in a manner which closely ties it to the true case temperature of the LED Array under steady state operation. Deviations between thermal measurements taken at the point indicated and the back of the LED Array differ by less than 1°C, providing a robust method to testing thermal operation once the product is installed.

## Flux Characteristics

Table 1: Flux Characteristics

Color	Base Part Number	Typical Luminous Flux $\phi_v$ (lm), $T_{case}=60^{\circ}C$ [3]	Minimum Luminous Flux $\phi_v$ (lm), $T_j=25^{\circ}C$ [1]	Typical Luminous Flux $\phi_v$ (lm), $T_j=25^{\circ}C$	Test Current (mA) [2]
Warm White	BXRA-W0401	400	400	440	700
	BXRA-W0402	420	400	460	700
	BXRA-W0802	850	800	930	1050
	BXRA-W1202	1200	1200	1320	1200
	BXRA-W1203	1240	1200	1370	1050
Neutral White	BXRA-N0402	400	400	440	600
	BXRA-N0802	920	880	1020	1050
	BXRA-N1203	1380	1380	1530	1050
Cool White	BXRA-C0402	410	400	450	500
	BXRA-C0802	800	800	880	700
	BXRA-C1202	1200	1200	1320	1050
	BXRA-C2002	2000	2000	2200	1500

Notes for Table 1:

1. Bridgelux maintains a  $\pm 7\%$  tolerance of flux measurements.
2. Parts are tested in pulsed conditions,  $T_j = 25^{\circ}C$ . Pulse width is 10 ms at rated test current.
3. Typical performance when driven with direct current using Bridgelux test set-up. Please contact a Bridgelux sales representative for additional details.

## Optical Characteristics

Table 2: Optical Characteristics

Color	Base Part Number	Color Temperature (CCT) <sup>[1],[2],[3]</sup>			Typical Color Rendering Index <sup>[4]</sup>	Typical Viewing Angle (Degrees) $2\theta_{1/2}$ <sup>[6]</sup>	Typical Center Beam Candle Power (cd) <sup>[5]</sup>
		Min	Typ	Max			
Warm White	BXRA-W0401	2850 K	3000 K	3700 K	82	120	140
	BXRA-W0402					120	145
	BXRA-W0802					120	295
	BXRA-W1202					120	420
	BXRA-W1203					120	435
Neutral White	BXRA-N0402	3700K	4100 K	4750K	80	120	140
	BXRA-N0802					120	325
	BXRA-N1203					120	480
Cool White	BXRA-C0402	4750 K	5600 K	7000 K	65	120	145
	BXRA-C0802					120	280
	BXRA-C1202					120	420
	BXRA-C2002					120	700

Notes for Table 2:

1. Parts are tested in pulsed conditions,  $T_j = 25^\circ\text{C}$ . Pulse width is 10 ms at rated test current.
2. Refer to Flux Characteristic Table for test current data.
3. Product is binned for color in x y coordinates.
4. Higher CRI options available upon request.
5. Center beam candle power is a calculated value based on lambertian radiation pattern at nominal test current.
6. Viewing angle is the off axis angle from the centerline where  $I_v$  is  $\frac{1}{2}$  of the peak value.

## Electrical Characteristics

Table 3: Electrical Characteristics

Color	Base Part Number	Forward Voltage Vf (V) <sup>[1],[2]</sup>			Test Current (mA) <sup>[2]</sup>	Typical Temperature Coefficient of Forward Voltage (mV/°C) $\Delta V_f/\Delta T_j$	Typical Thermal Resistance Junction to Case (°C/W) $R\theta_{j-c}$
		Min	Typ	Max			
Warm White	BXRA-W0401	8.7	9.5	10.3	700	-3 to -9	1.0
	BXRA-W0402	8.3	9.0	9.7	700	-3 to -9	1.0
	BXRA-W0802	11.2	12.2	13.2	1050	-4 to -12	0.7
	BXRA-W1202	13.9	15.1	16.3	1200	-5 to -15	0.5
	BXRA-W1203	17.3	18.3	19.8	1050	-6 to -18	0.5
Neutral White	BXRA-N0402	8.4	8.9	9.7	600	-3 to -9	1.0
	BXRA-N0802	11.2	12.2	13.2	1050	-4 to -12	0.7
	BXRA-N1203	17.3	18.3	19.8	1050	-6 to -18	0.5
Cool White	BXRA-C0402	8.7	9.5	10.3	500	-3 to -9	1.4
	BXRA-C0802	11.7	12.7	13.7	700	-4 to -12	0.8
	BXRA-C1202	11.8	12.8	13.8	1050	-4 to -12	0.7
	BXRA-C2002	14.9	16.2	17.5	1500	-5 to -15	0.5

Notes for Table 3:

1. Parts are tested in pulsed conditions,  $T_j = 25^\circ\text{C}$ . Pulse width is 10 ms at rated test current.
2. Bridgelux maintains a tester tolerance of  $\pm 0.10$  V on forward voltage measurements.



## Absolute Minimum and Maximum Ratings

Table 4: Minimum and Maximum Current and Reverse Voltage Ratings

Part Number	Maximum DC Forward Current (mA)	Minimum DC Forward Current (mA) <sup>[2]</sup>	Maximum Peak Pulsed Current (mA) <sup>[3]</sup>	Maximum Reverse Voltage (Vr) <sup>[1]</sup>
BXRA-W0401	1500	450	2100	-15 Volts
BXRA-W0402	1500	450	2100	-15 Volts
BXRA-W0802	2000	600	2800	-20 Volts
BXRA-W1202	2500	750	3500	-25 Volts
BXRA-W1203	2000	600	2800	-30 Volts
BXRA-N0402	1500	450	2100	-15 Volts
BXRA-N0802	2000	600	2800	-20 Volts
BXRA-N1203	2000	600	2800	-30 Volts
BXRA-C0402	1000	300	1400	-15 Volts
BXRA-C0802	1500	450	2100	-20 Volts
BXRA-C1202	2000	600	2800	-20 Volts
BXRA-C2002	2500	750	3500	-25 Volts

Notes for Table 4:

1. Light emitting diodes are not designed to be driven in reverse voltage.
2. Driving these high current devices at low currents can result in variations in performance. For low current operation pulse width modulation is recommended.
3. Bridgelux recommends a maximum duty cycle of 10% when operating LED Arrays at the maximum peak pulsed current specified.

Table 5: Maximum Ratings

Parameter	Maximum Rating
LED Junction Temperature	150°C
Storage Temperature	-40°C to +105°C
Operating Case Temperature	105°C
Soldering Temperature	3.5 seconds, 350°C or lower

## Typical Performance at Alternative Drive Currents

The Bridgelux LED Arrays are tested and binned against the specifications shown in Tables 1, 2 and 3. Customers also have options to drive the LED Arrays at alternative drive currents dependent on the specific application. The typical performance at any drive current can be derived from the flux vs. current characteristics shown in Figures 8-11 and from the current vs. voltage characteristics shown in Figures 15-24. The typical performance at common drive currents is also summarized in Table 6 for warm white products, Table 7 for neutral white products and Table 8 for cool white products.

Table 6: Typical Product Performance at Alternative Drive Currents – Warm White

Color	Part Number	Typical Luminous Flux $\phi_v$ (lm), $T_{case}=60^{\circ}C$	Typical Luminous Flux $\phi_v$ (lm), $T_j=25^{\circ}C$	Typical Forward Voltage $V_f$ (V)	Forward Current (mA) <sup>[2]</sup>
Warm White	BXRA-W0401	290	325	9.2	500
		<b>400</b>	<b>440</b>	<b>9.5</b>	<b>700</b> <sup>[1]</sup>
		560	620	9.9	1050
	BXRA-W0402	315	350	8.8	500
		<b>420</b>	<b>460</b>	<b>9.0</b>	<b>700</b> <sup>[1]</sup>
		600	660	9.5	1050
	BXRA-W0802	430	480	11.4	500
		580	640	11.7	700
		<b>850</b>	<b>930</b>	<b>12.2</b>	<b>1050</b> <sup>[1]</sup>
		1050	1170	12.6	1400
	BXRA-W1202	740	820	14.4	700
		1060	1180	14.9	1050
		<b>1200</b>	<b>1320</b>	<b>15.1</b>	<b>1200</b> <sup>[1]</sup>
		1360	1510	15.4	1400
		1640	1820	15.8	1750
	BXRA-W1203	630	700	17.1	500
		860	960	17.6	700
		<b>1230</b>	<b>1370</b>	<b>18.3</b>	<b>1050</b> <sup>[1]</sup>
		1570	1750	18.9	1400

Notes for Table 6:

1. Product is tested and binned at the specified drive current.
2. Operating these LED Arrays at or below the drive currents listed in Table 6, with a case temperature maintained at or below 70°C, will enable the average lumen maintenance projection outlined earlier in this Product Data Sheet.

Typical Performance at Alternative Drive Currents (continued)

Table 7: Typical Product Performance at Alternative Drive Currents – Neutral White

Color	Part Number	Typical Luminous Flux $\phi_v$ (lm), $T_{case}=60^{\circ}C$	Typical Luminous Flux $\phi_v$ (lm), $T_j=25^{\circ}C$	Typical Forward Voltage $V_f$ (V)	Forward Current (mA) <sup>[2]</sup>
Neutral White	BXRA-N0402	330	370	8.8	500
		<b>400</b>	<b>440</b>	<b>8.9</b>	<b>600</b> <sup>[1]</sup>
		450	500	9.0	700
	BXRA-N0802	470	525	11.4	500
		640	710	11.7	700
		<b>920</b>	<b>1020</b>	<b>12.2</b>	<b>1050</b> <sup>[1]</sup>
		1170	1300	12.6	1400
	BXRA-N1203	710	790	17.1	500
		960	1070	17.6	700
		<b>1380</b>	<b>1530</b>	<b>18.3</b>	<b>1050</b> <sup>[1]</sup>
		1750	1950	18.9	1400

Notes for Table 7:

1. Product is tested and binned at the specified drive current.
2. Operating these LED Arrays at or below the drive currents listed in Table 7, with a case temperature maintained at or below 70°C, will enable the average lumen maintenance projection outlined earlier in this Product Data Sheet.

Typical Performance at Alternative Drive Currents (continued)

Table 8: Typical Product Performance at Alternative Drive Currents – Cool White

Color	Part Number	Typical Luminous Flux $\phi_v$ (lm), $T_{case}=60^{\circ}C$	Typical Luminous Flux $\phi_v$ (lm), $T_j=25^{\circ}C$	Typical Forward Voltage $V_f$ (V)	Forward Current (mA) <sup>[2]</sup>
Cool White	BXRA-C0402	315	340	9.2	350
		<b>410</b>	<b>450</b>	<b>9.5</b>	<b>500</b> <sup>[1]</sup>
		560	620	9.9	700
	BXRA-C0802	590	650	12.2	500
		<b>800</b>	<b>880</b>	<b>12.7</b>	<b>700</b> <sup>[1]</sup>
		1120	1240	13.2	1050
	BXRA-C1202	830	920	12.3	700
		<b>1200</b>	<b>1320</b>	<b>12.8</b>	<b>1050</b> <sup>[1]</sup>
		1510	1680	13.2	1400
	BXRA-C2002	1020	1130	15.1	700
		1460	1620	15.6	1050
		1850	2050	16.1	1400
		<b>2000</b>	<b>2200</b>	<b>16.2</b>	<b>1500</b> <sup>[1]</sup>
		2270	2520	16.5	1750

Notes for Table 8:

1. Product is tested and binned at the specified drive current.
2. Operating these LED Arrays at or below the drive currents listed in Table 8, with a case temperature maintained at or below 70°C, will enable the average lumen maintenance projection outlined earlier in this Product Data Sheet.



## Mechanical Dimensions (continued)

Figure 2: Drawing for 800, 1200, and 2000 lumen product options (part numbers BXRA-C0802, BXRA-W0802, BXRA-C1202, BXRA-W1202, BXRA-W1203, BXRA-N0802, BXRA-N1203 and BXRA-C2002).

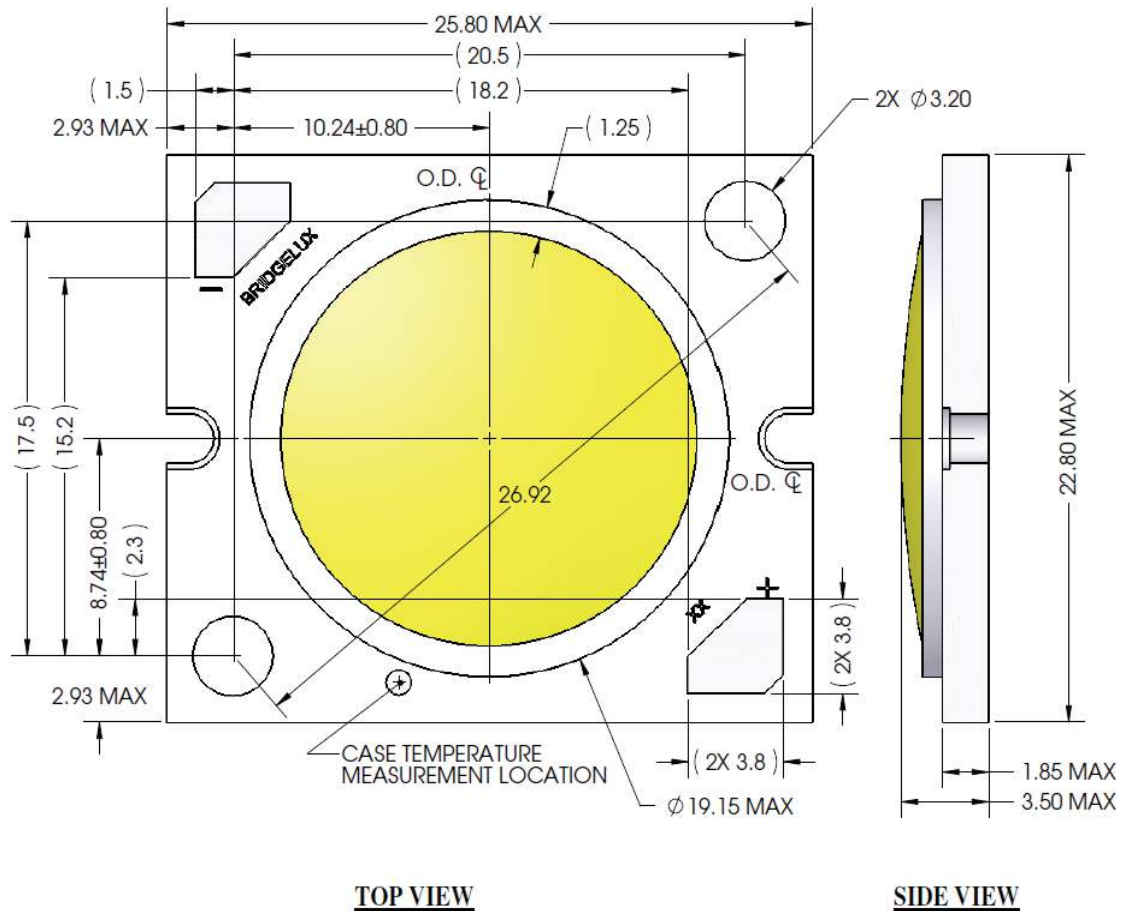

### Notes for Figure 2:

1. Mounting holes are for M2.5 or #4 screws.
2. Solder pads are labeled "+" and "-" to denote positive and negative, respectively.
3. Drawings are not to scale.
4. Drawing dimensions are in millimeters.
5. Bridgelux recommends two tapped holes for mounting screws with  $26.92 \pm 0.10$ mm center-to-center spacing.
6. Unless otherwise specified, tolerances are  $\pm 0.10$ mm.
7. Dimensions with parentheses "(" are for reference only.
8. Refer to product Application Notes AN10 and AN11 for product handling, mounting and heat sink recommendations.
9. The optical center of the LED Array is defined by the mechanical center of the array.

## Typical Radiation Pattern

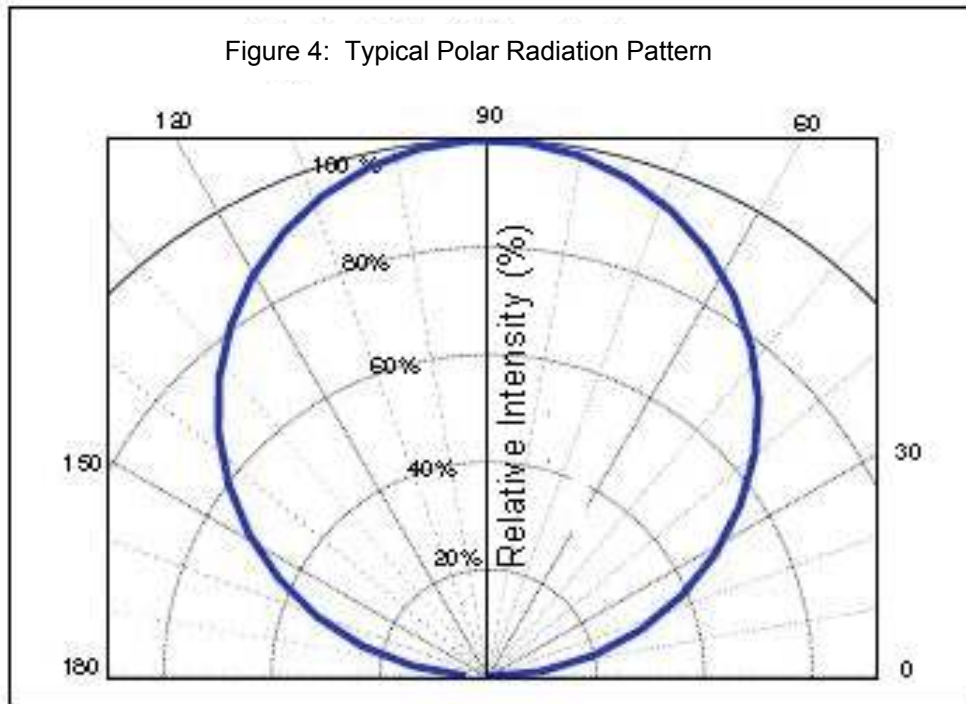
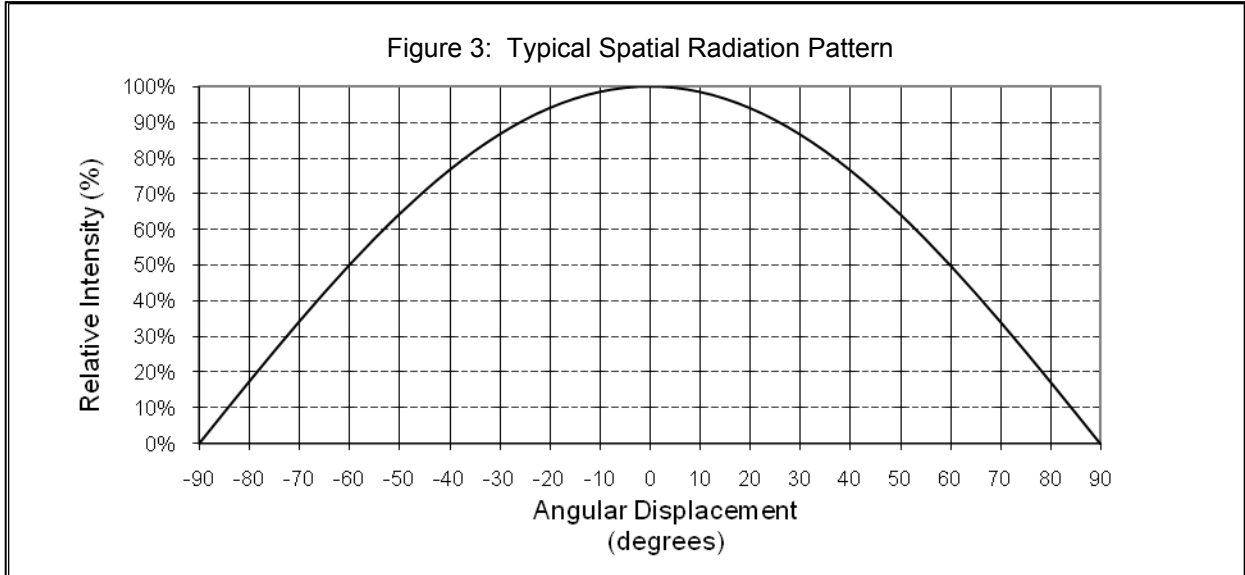

Wavelength Characteristics at Rated Test Current,  $T_j=25^\circ\text{C}$

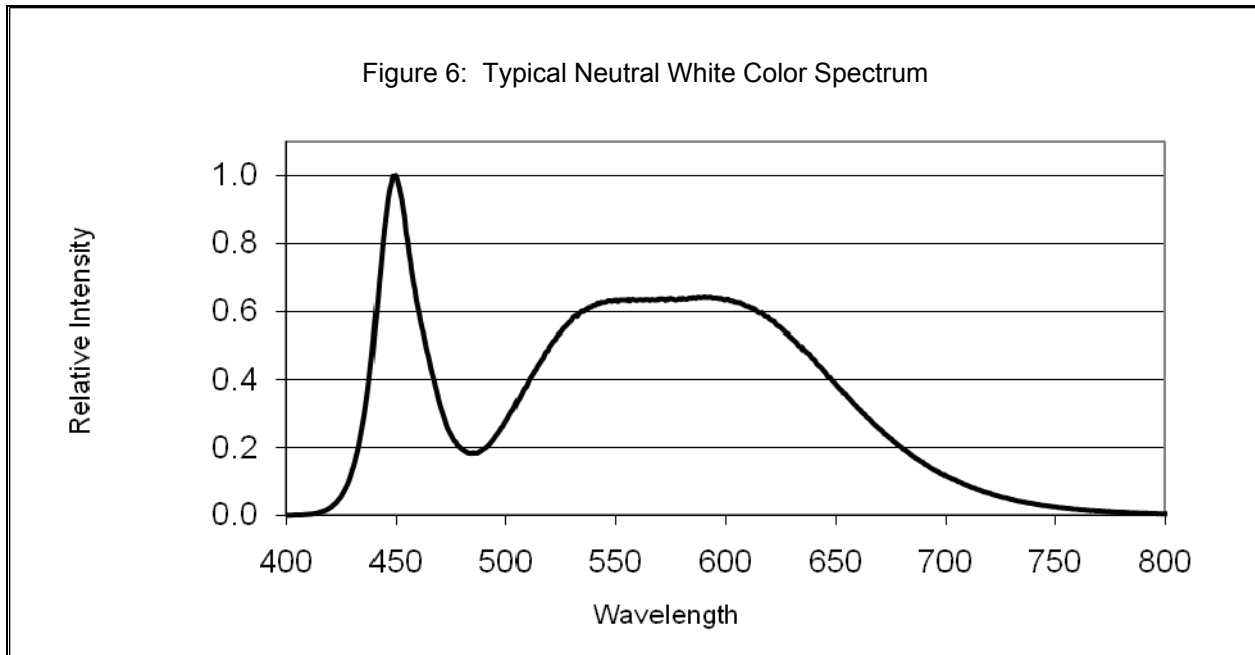
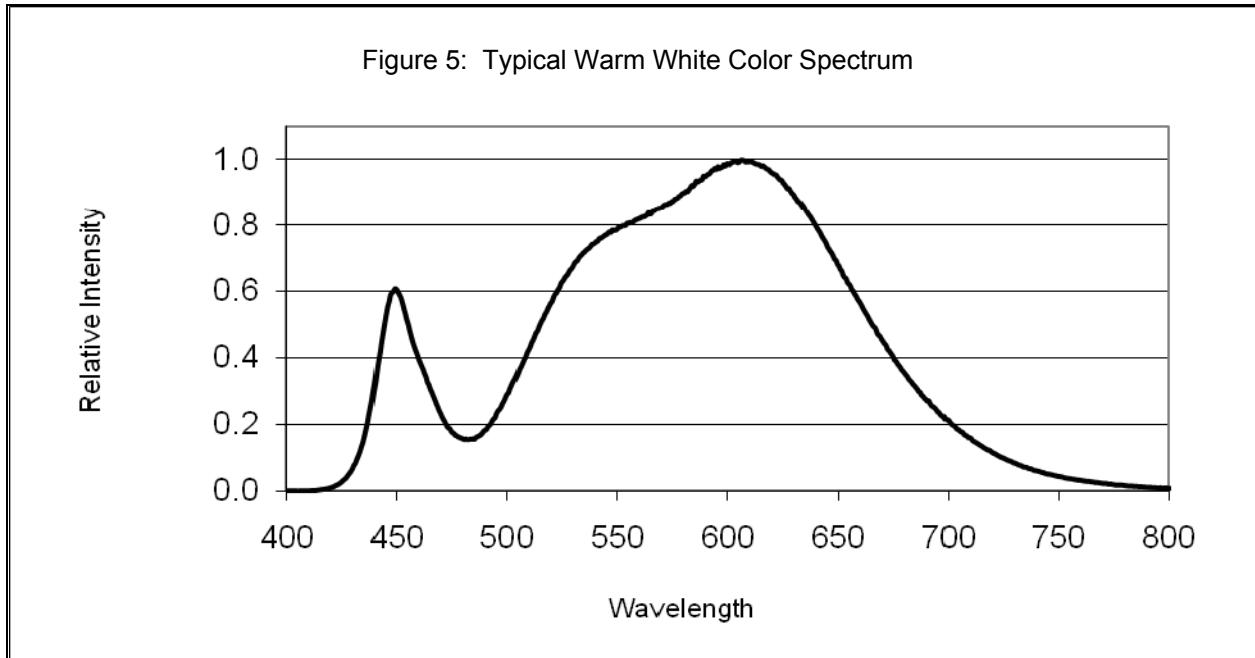



---

Wavelength Characteristics at Rated Test Current,  $T_j=25^\circ\text{C}$  (continued)

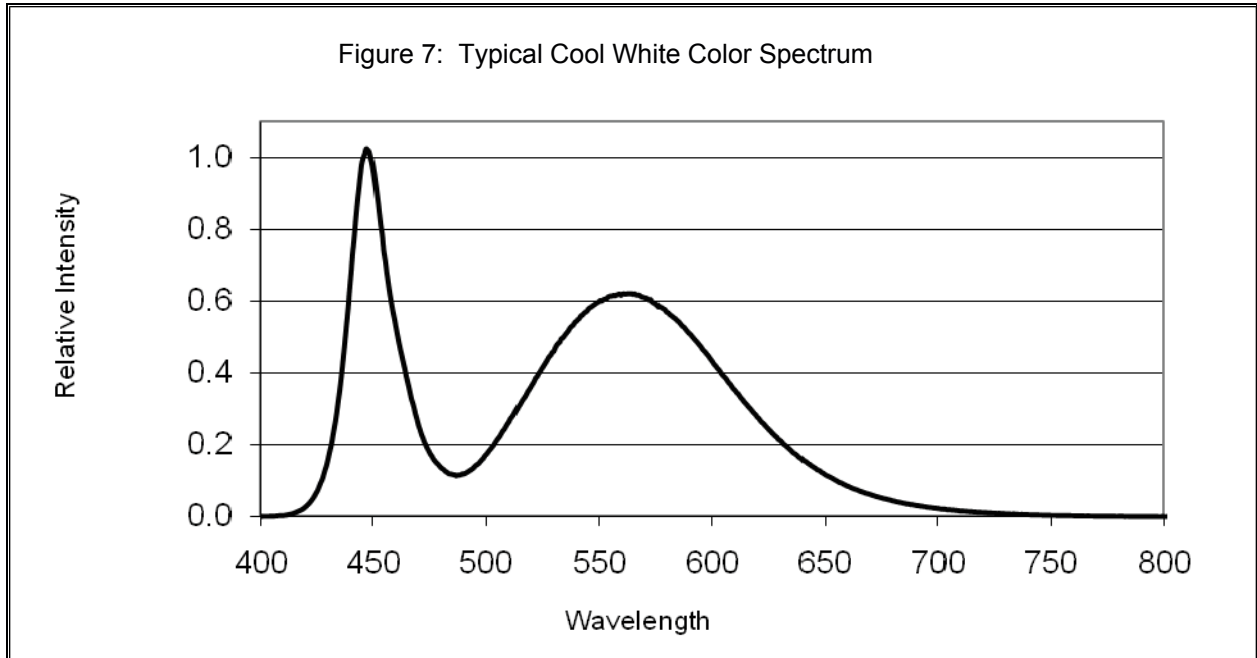

Typical Relative Luminous Flux vs. Current, T<sub>j</sub>=25° C

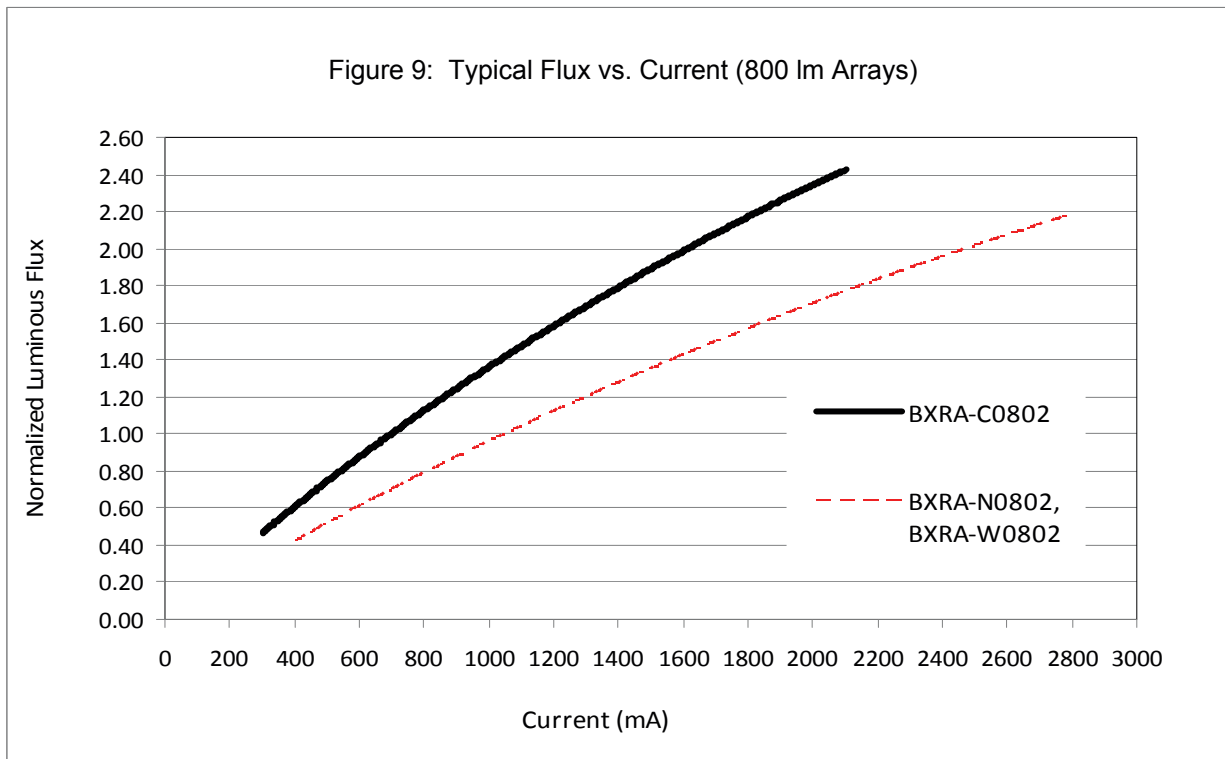
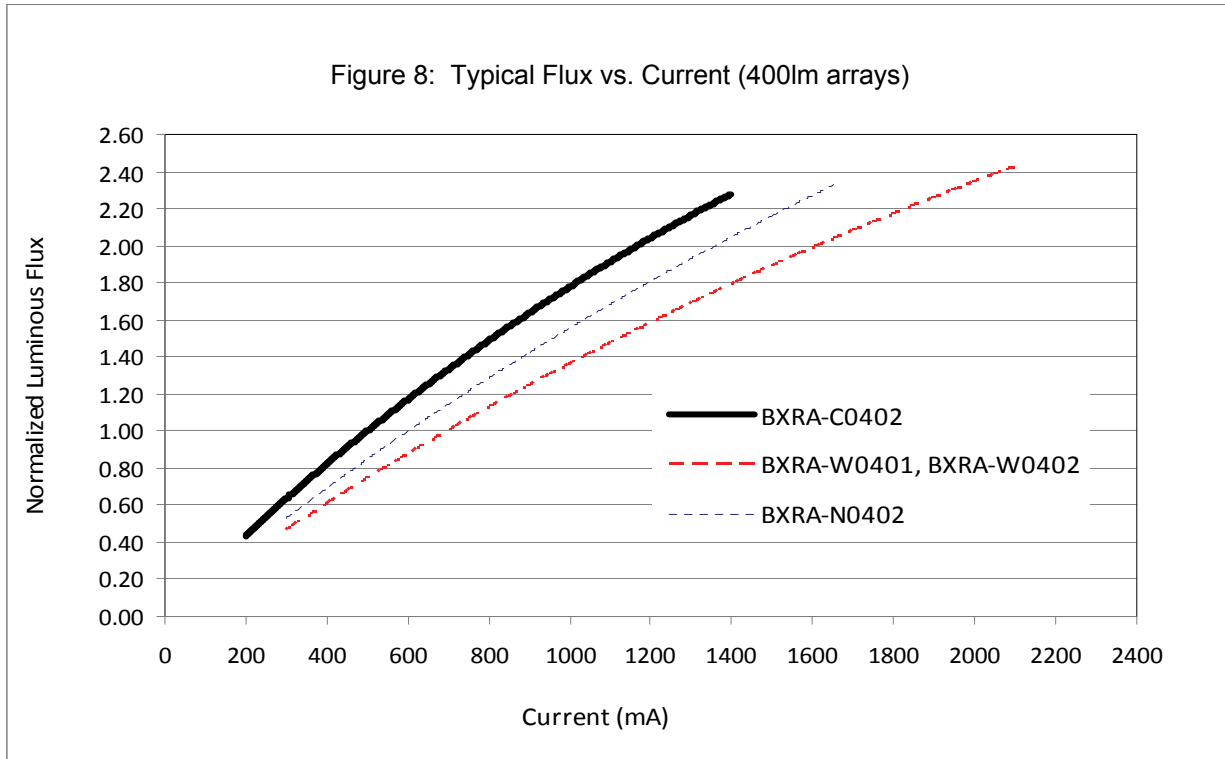

Typical Relative Luminous Flux vs. Current,  $T_j=25^\circ\text{C}$  (continued)

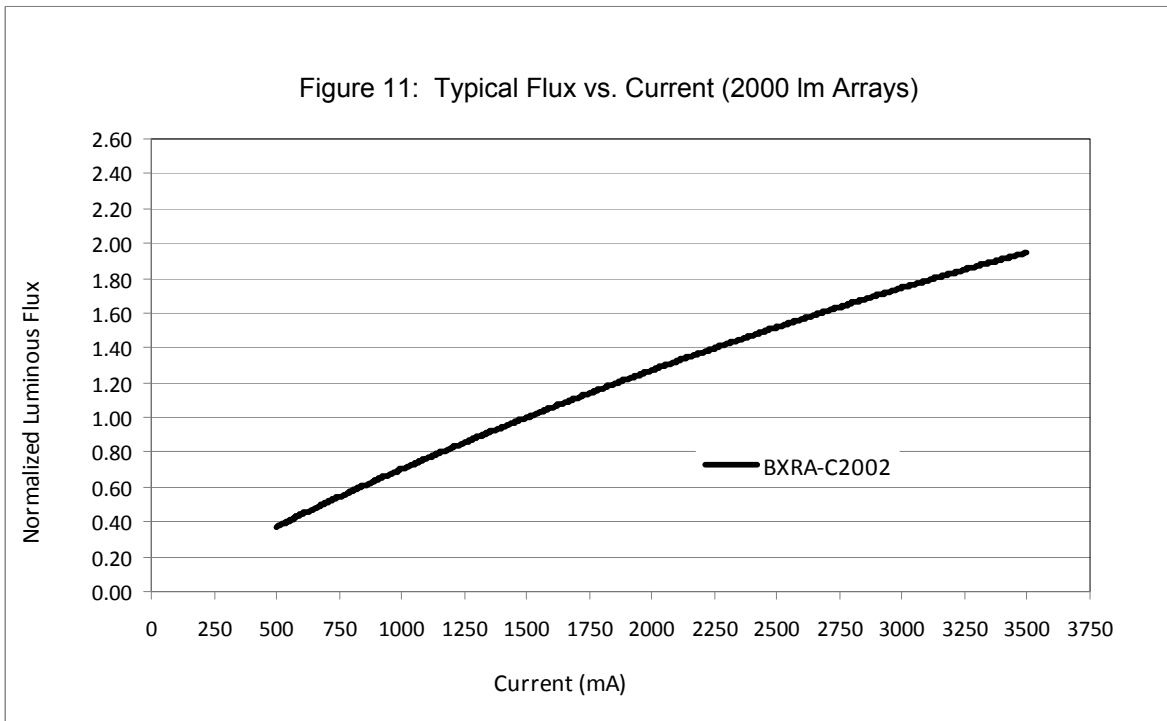
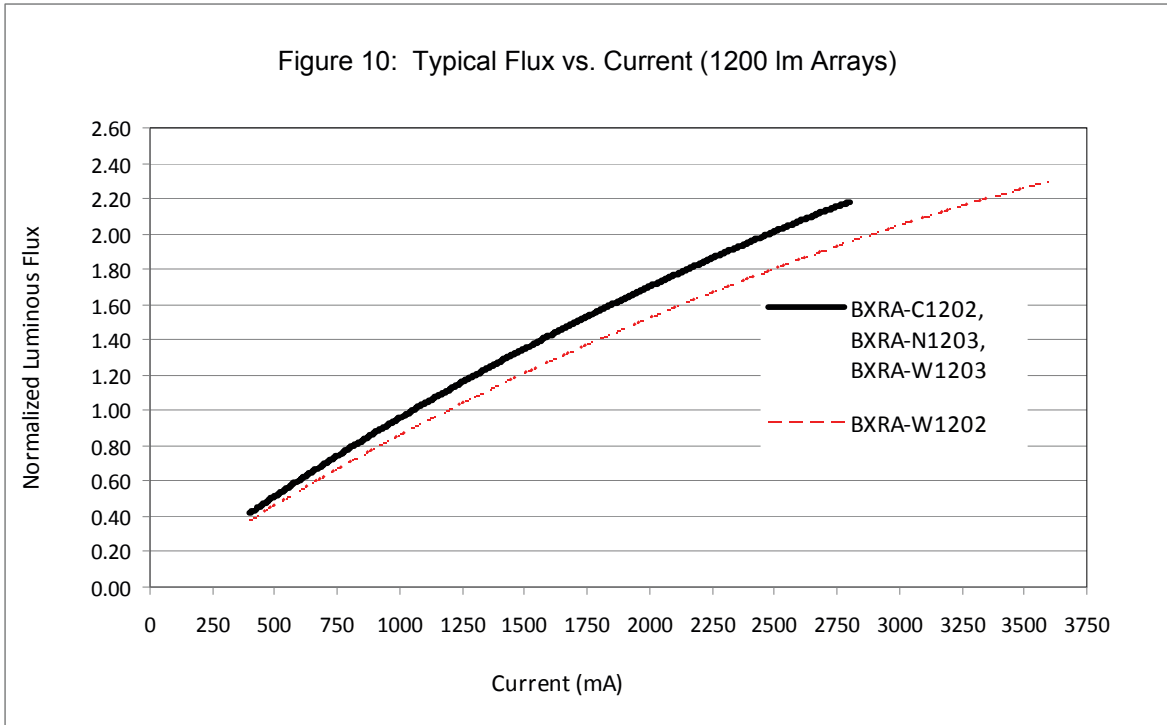

Note for Figures 8 through 11: Bridgelux does not recommend driving high power LED Arrays at low currents. Doing so may produce unpredictable results. Pulse width modulation (PWM) is recommended for dimming effects.

## Typical Light Output Characteristics vs. Temperature

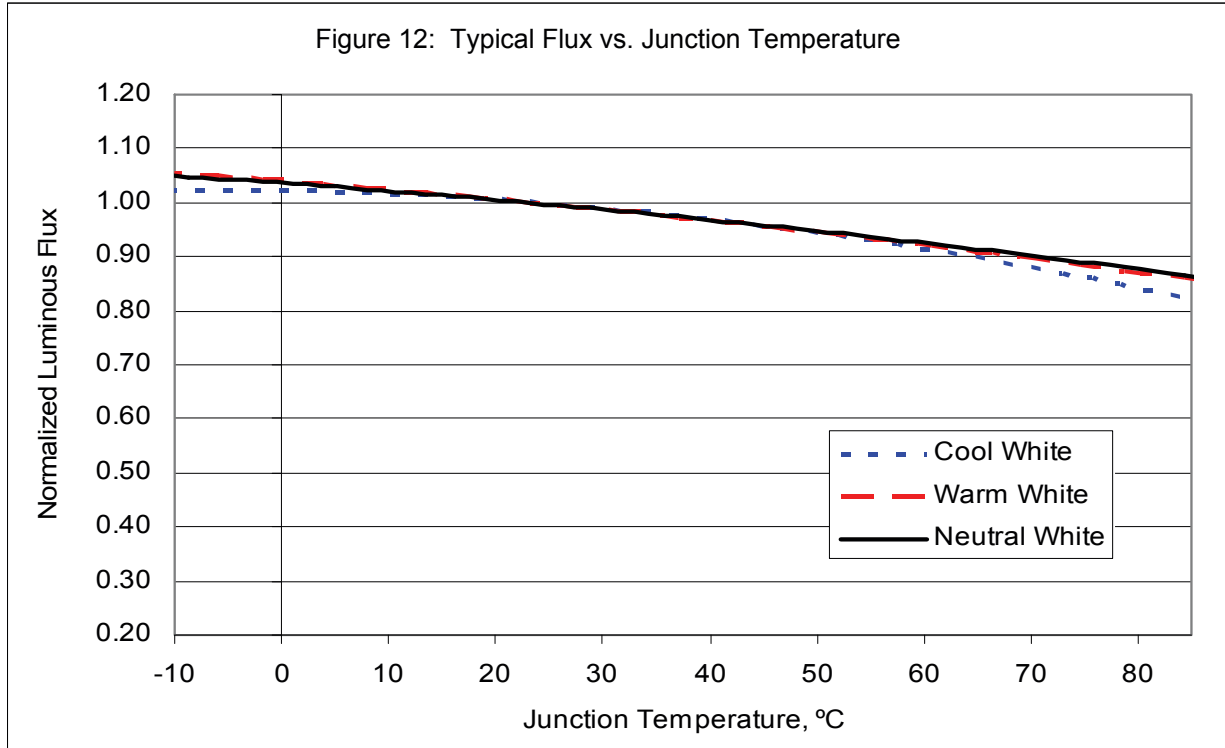

## Typical Chromaticity Characteristics vs. Temperature

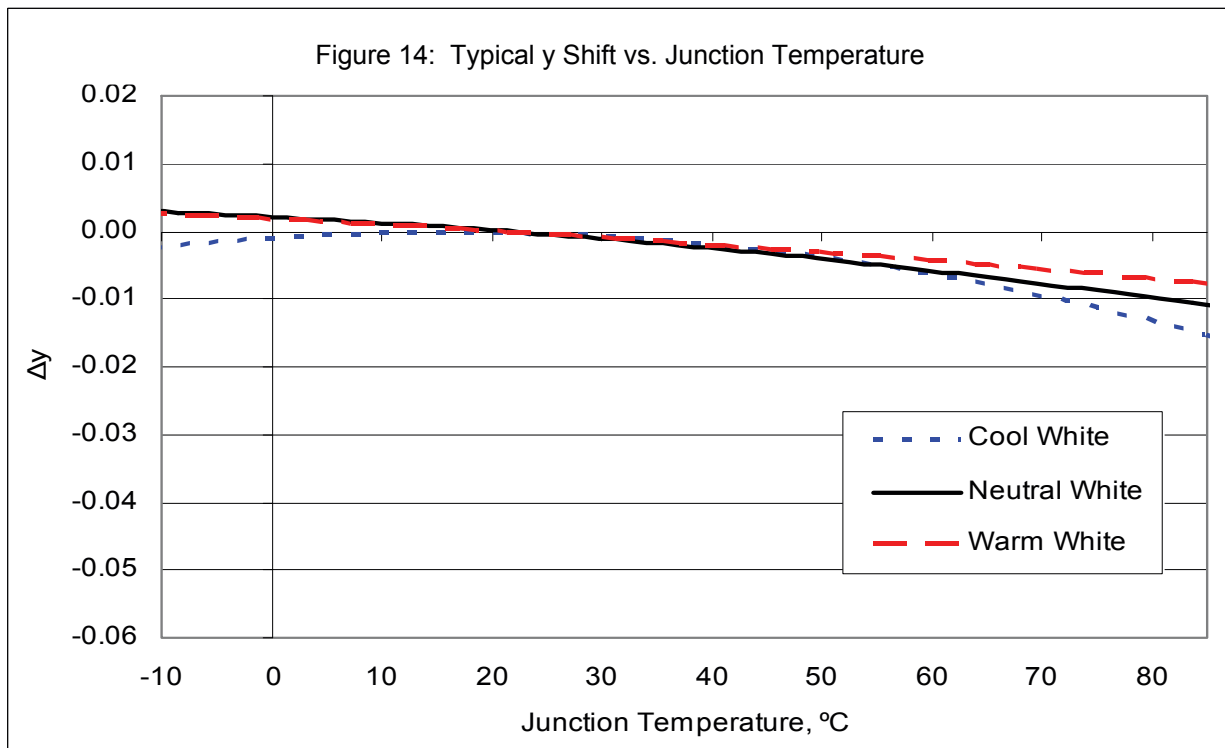
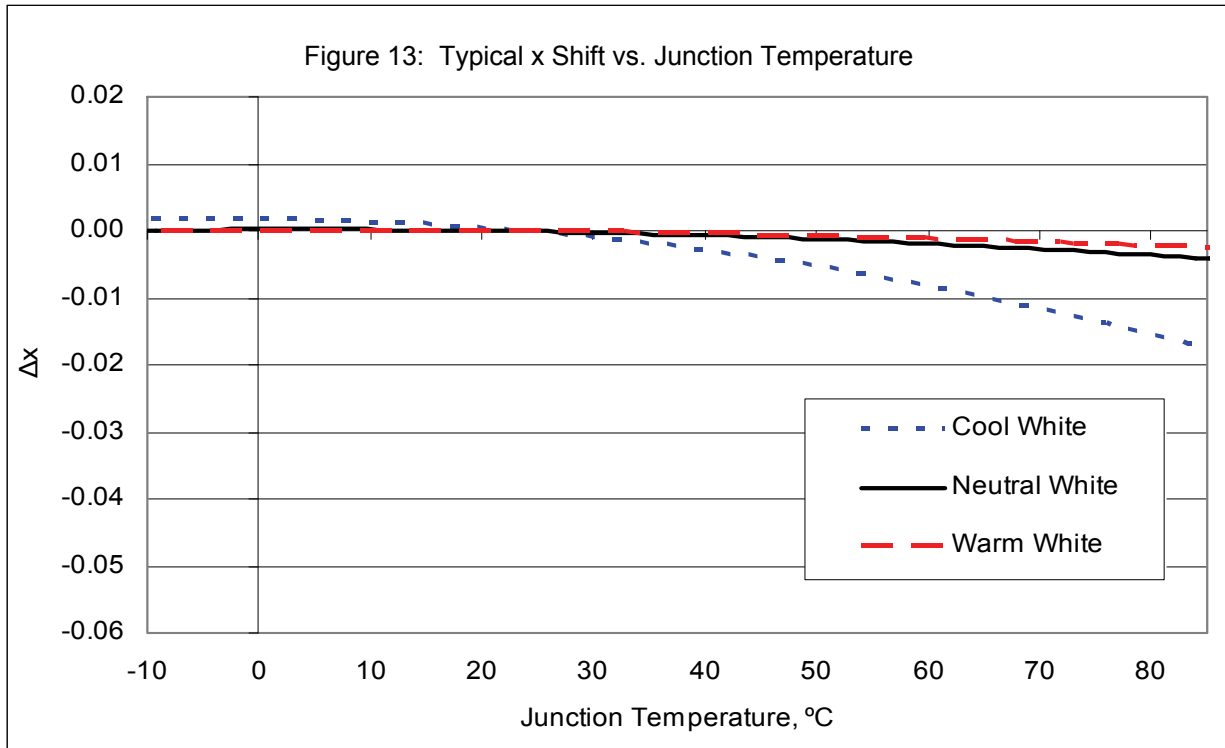

Typical Forward Current Characteristics at  $T_j = 25^\circ\text{C}$

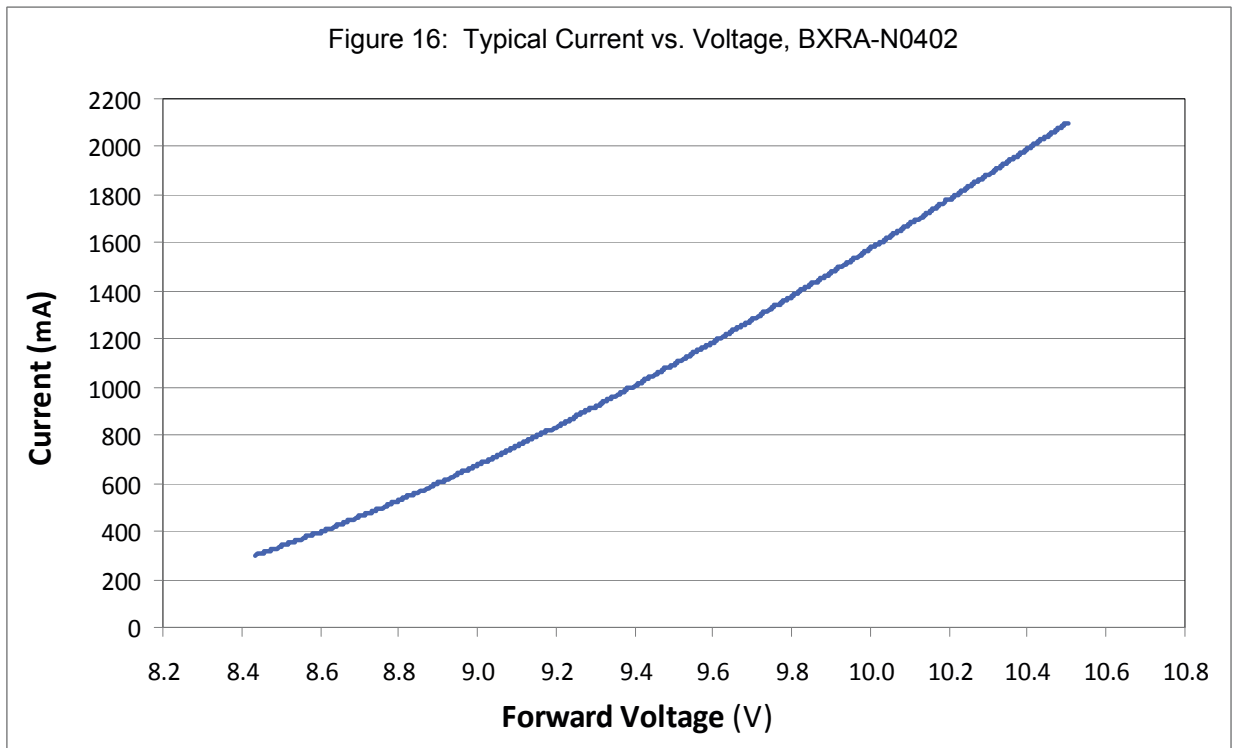
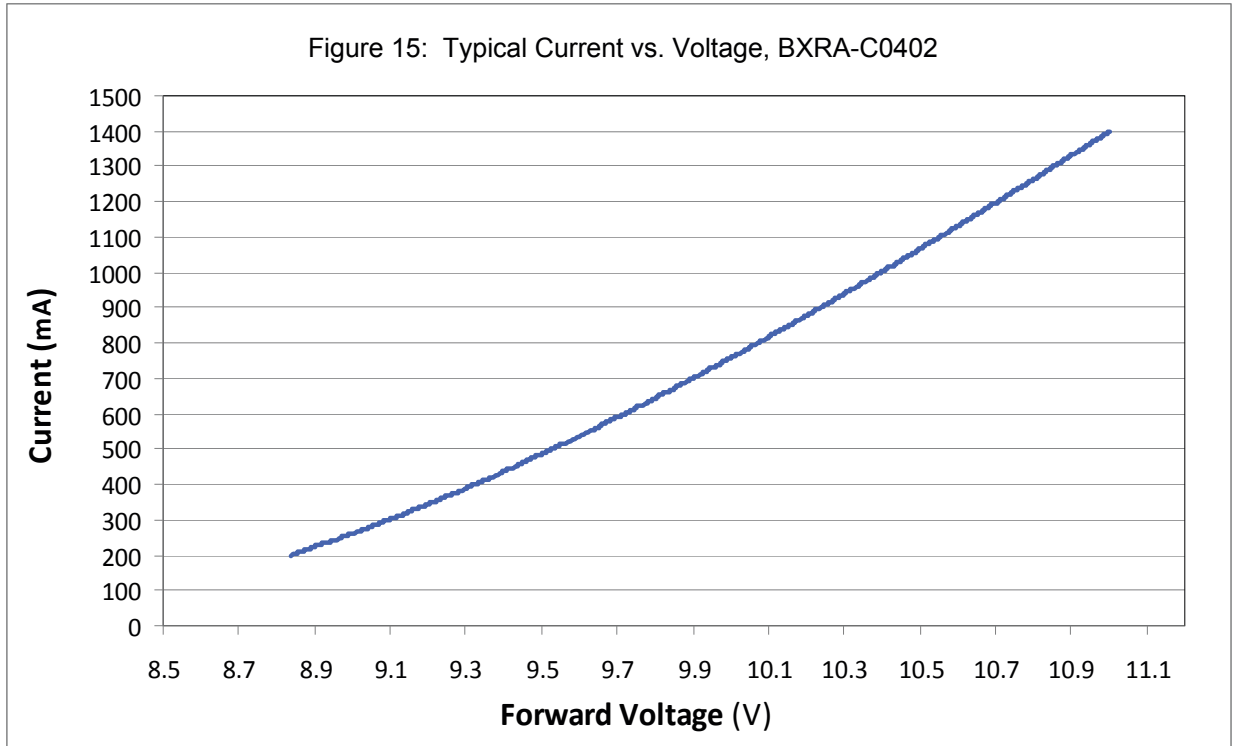

Typical Forward Current Characteristics at  $T_j = 25^\circ\text{C}$  (continued)

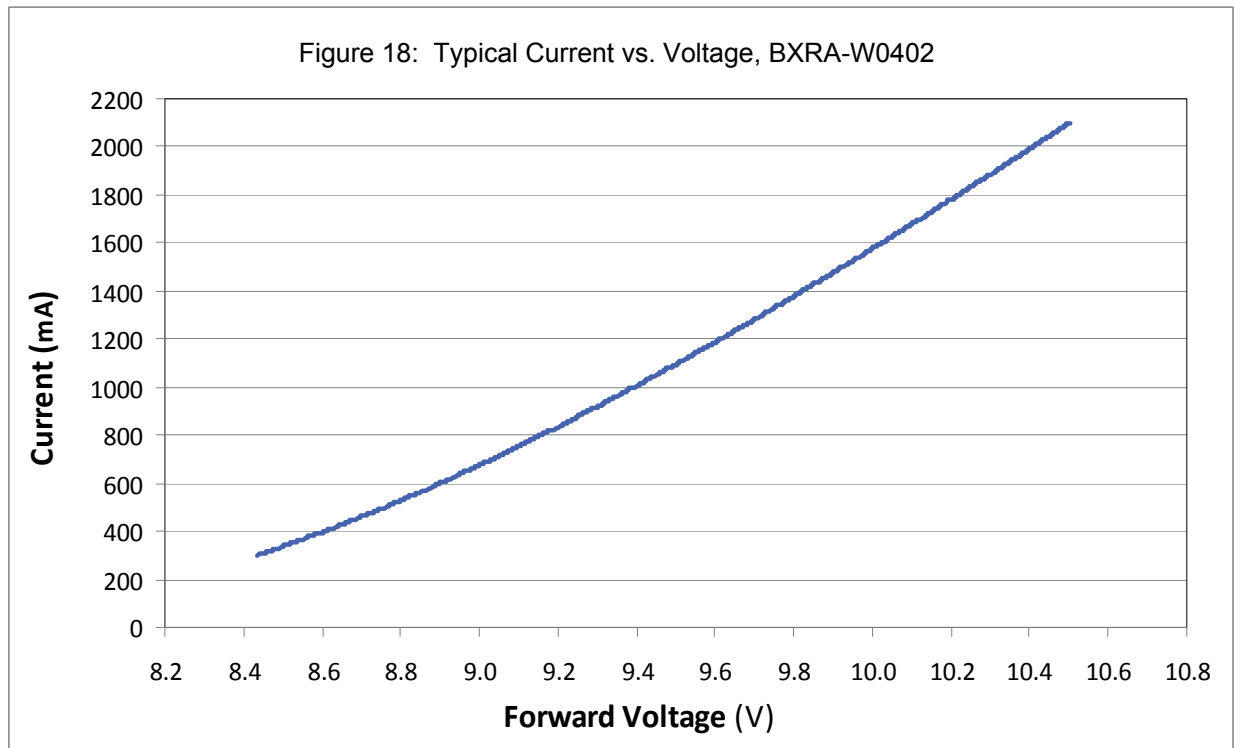
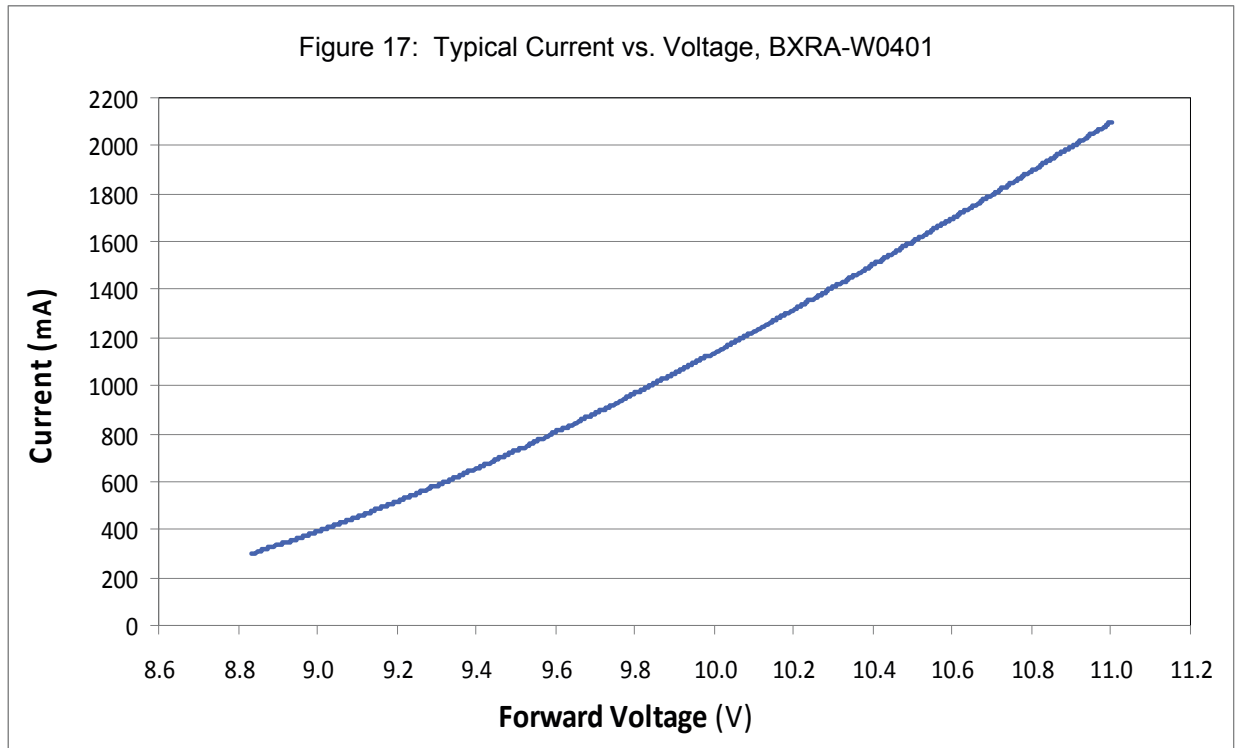

Typical Forward Current Characteristics at  $T_j = 25^\circ\text{C}$  (continued)

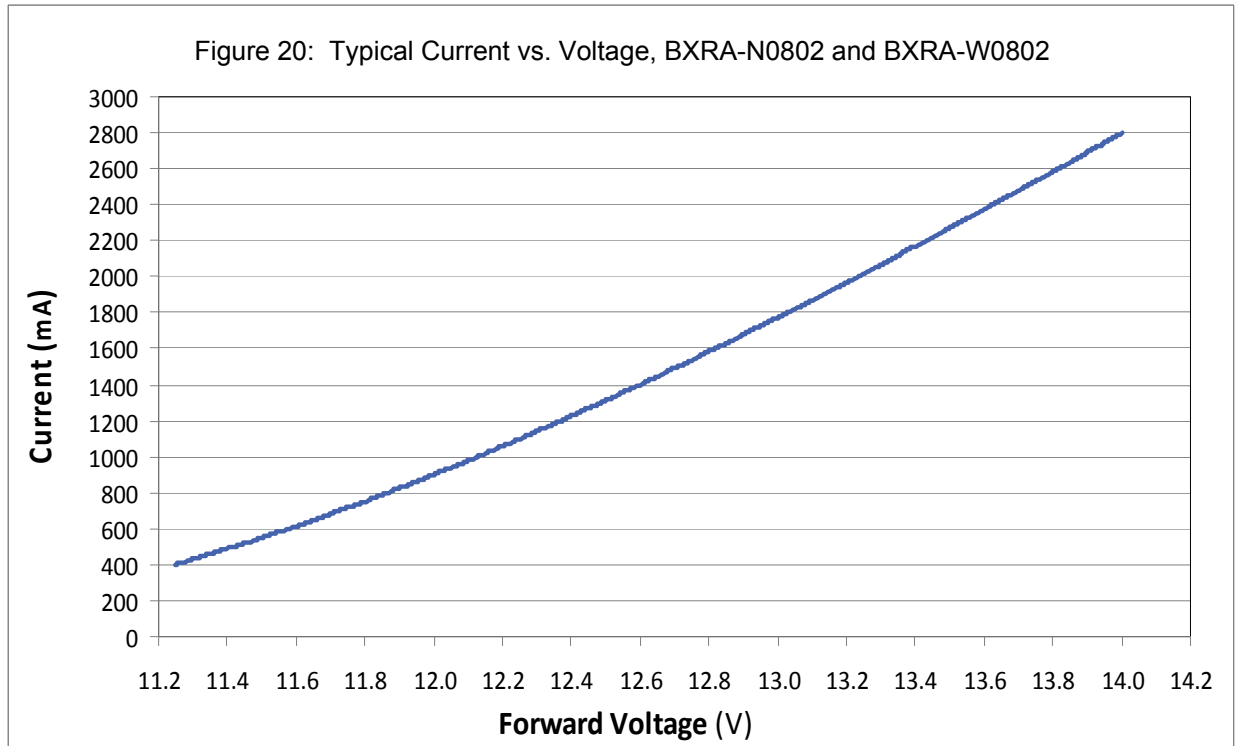
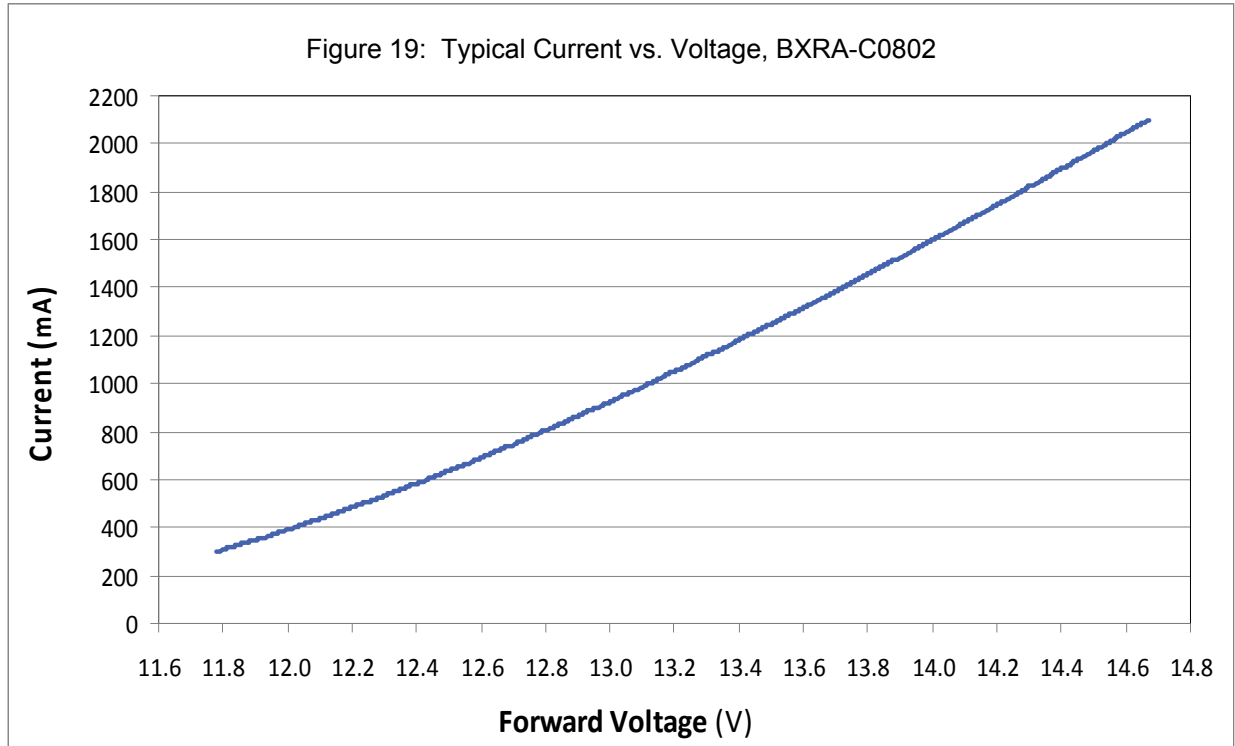



Typical Forward Current Characteristics at  $T_j = 25^\circ\text{C}$  (continued)

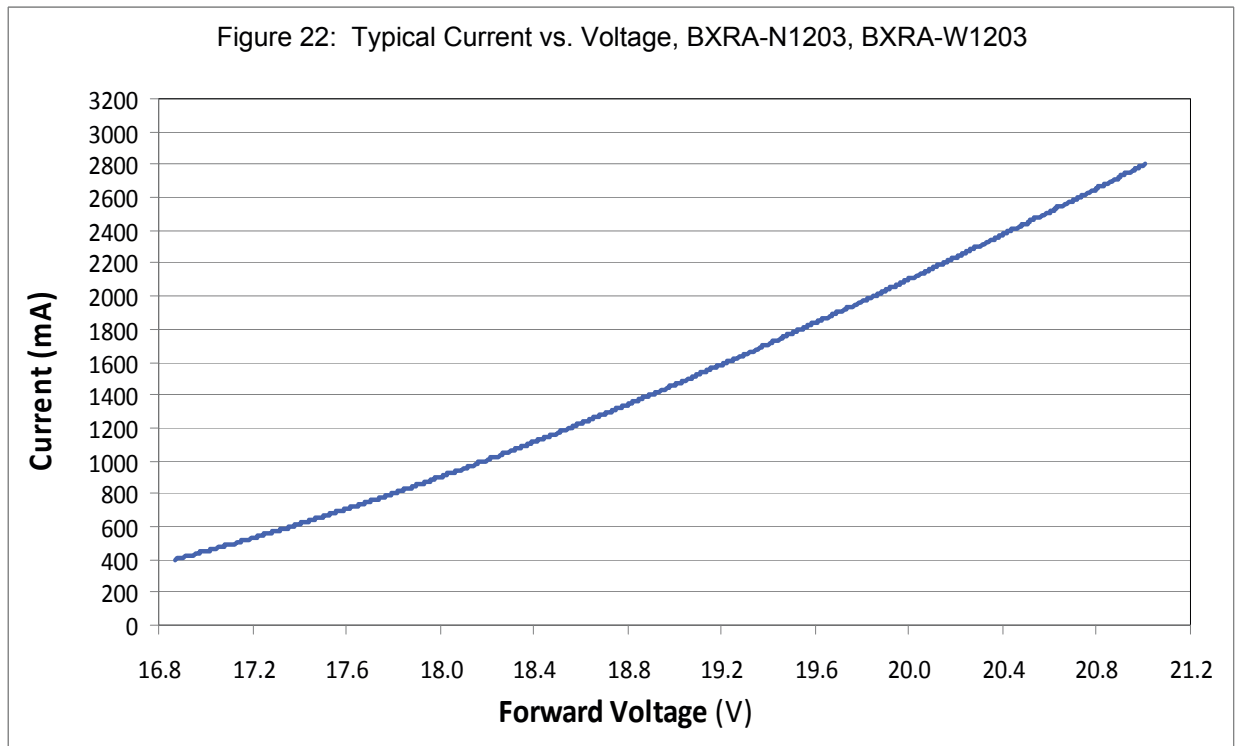
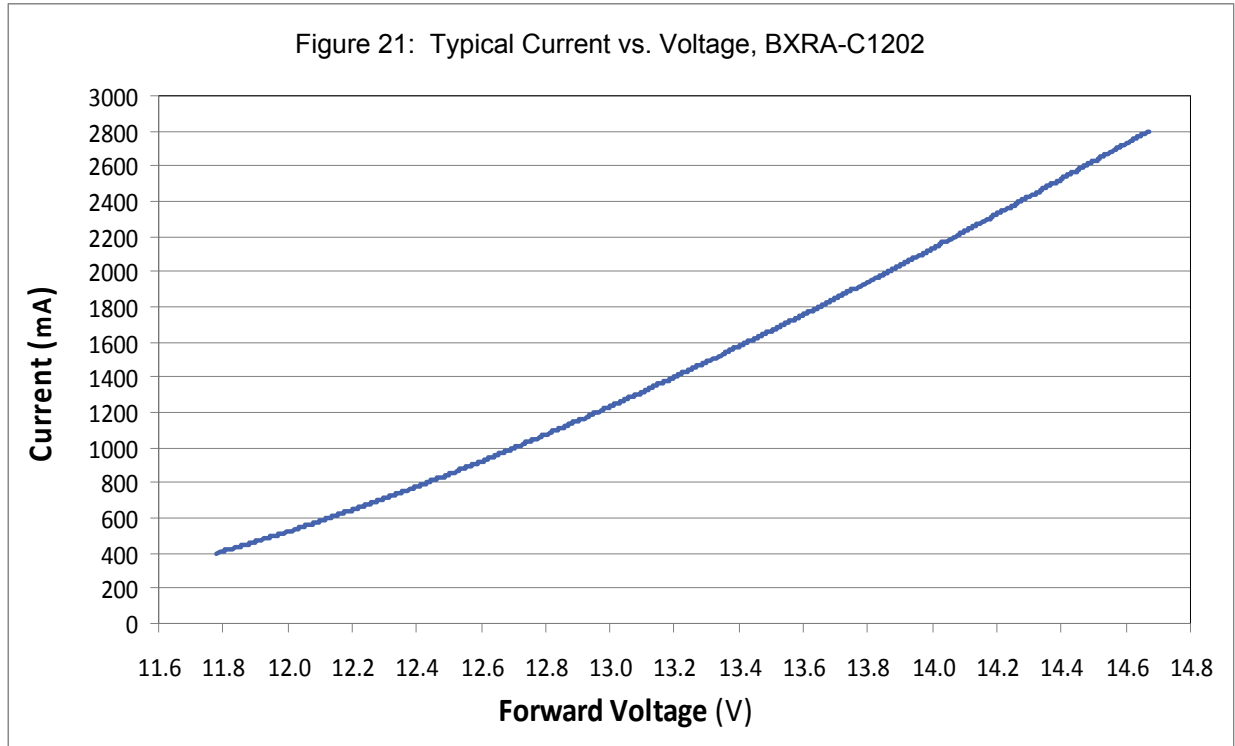

Typical Forward Current Characteristics at  $T_j = 25^\circ\text{C}$  (continued)

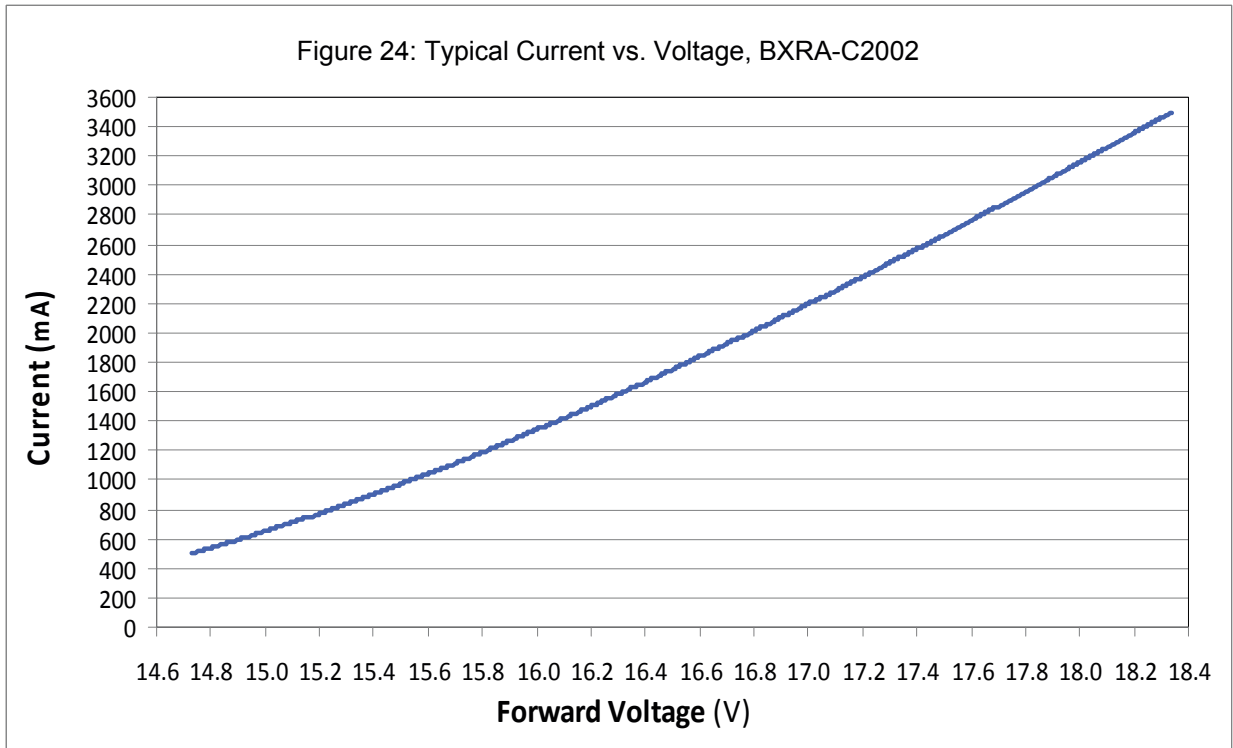
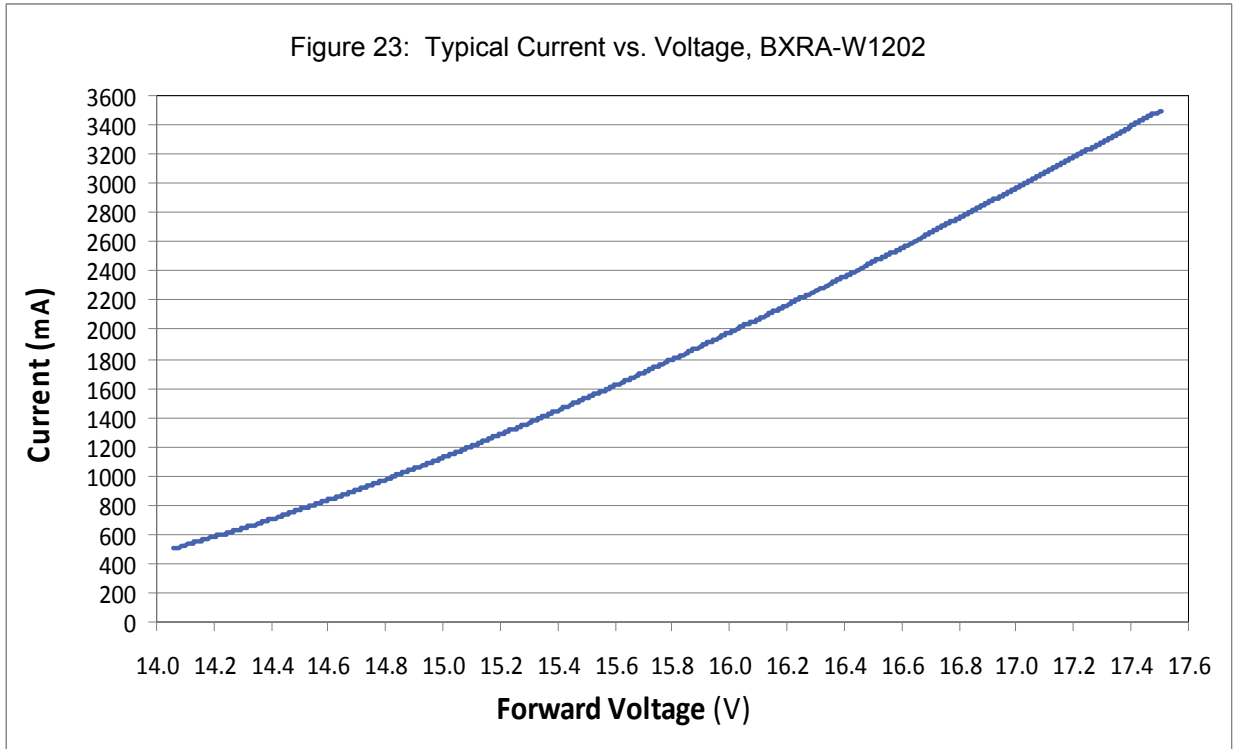

## Current Derating Curves

The graphs below illustrate the relationship between the system thermal resistance, drive current, and ambient temperature. Please note that absolute maximum ratings requirements, including that of maximum case temperature, must be adhered to in the system design. The thermal resistance values indicated in Figures 25-34 are total system values (junction to ambient) including the thermal resistance of the LED Array. Individual LED Array thermal resistance values are listed in Table 3.

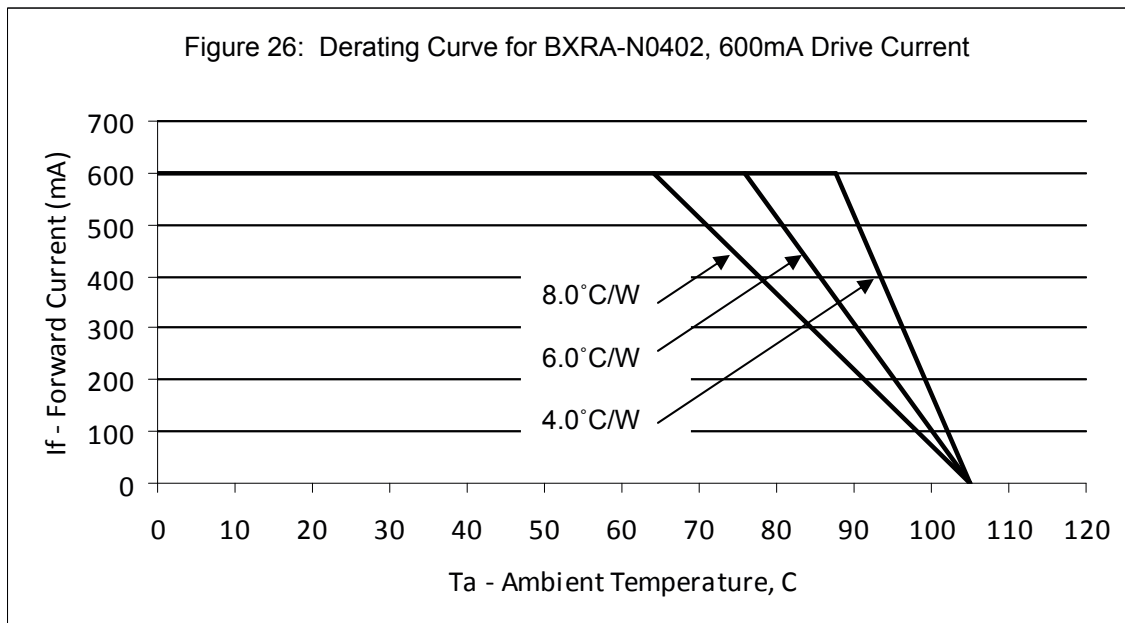
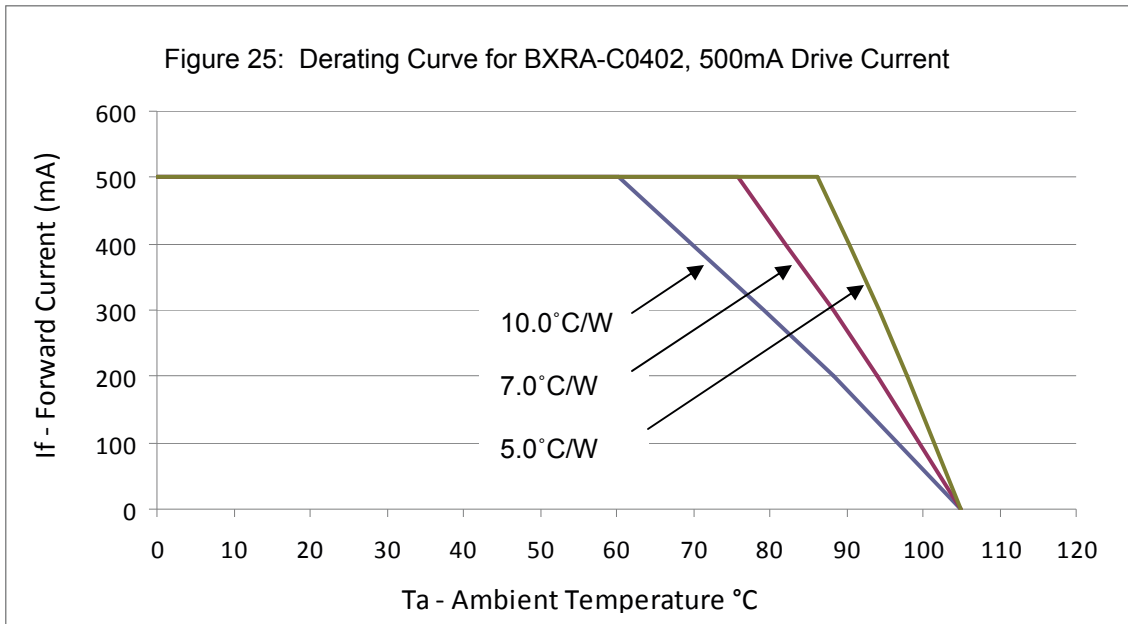

## Current Derating Curves (continued)

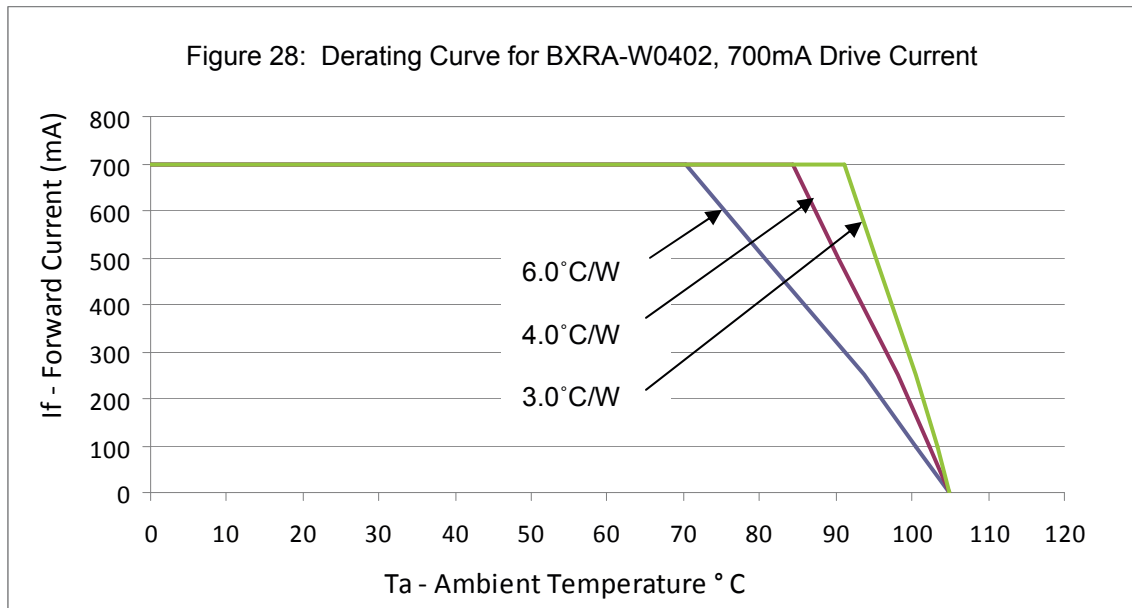
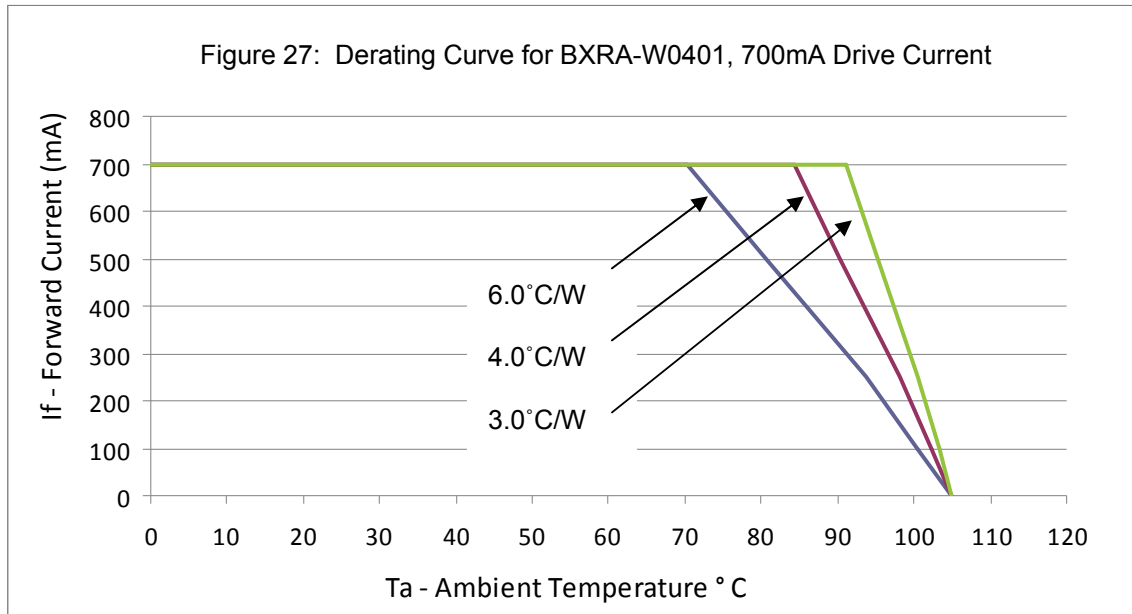

Current Derating Curves (continued)

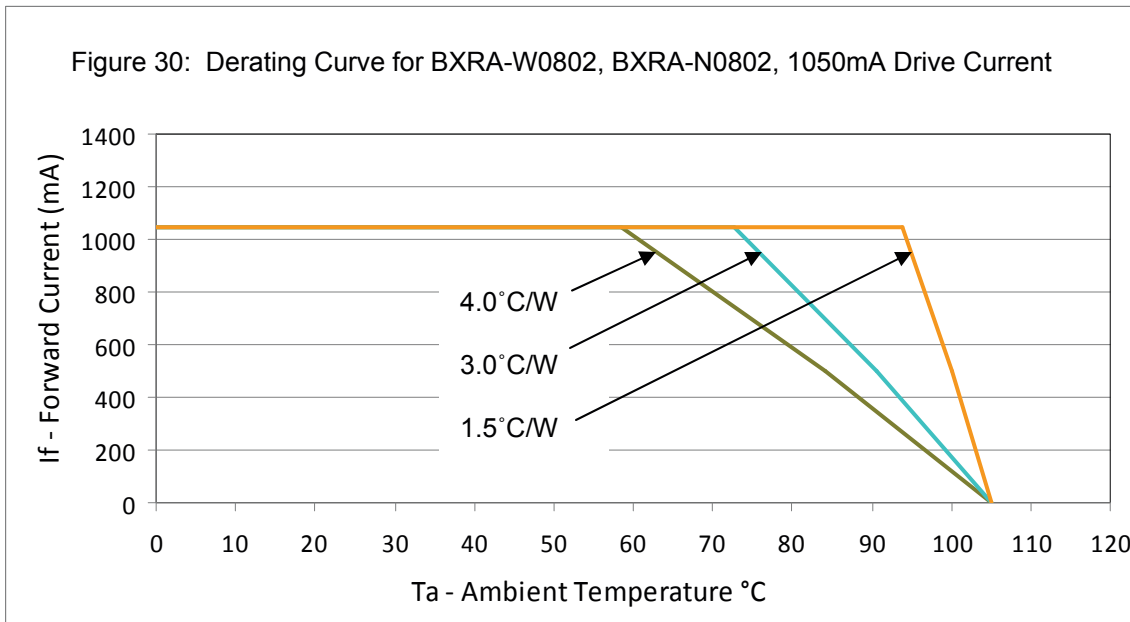
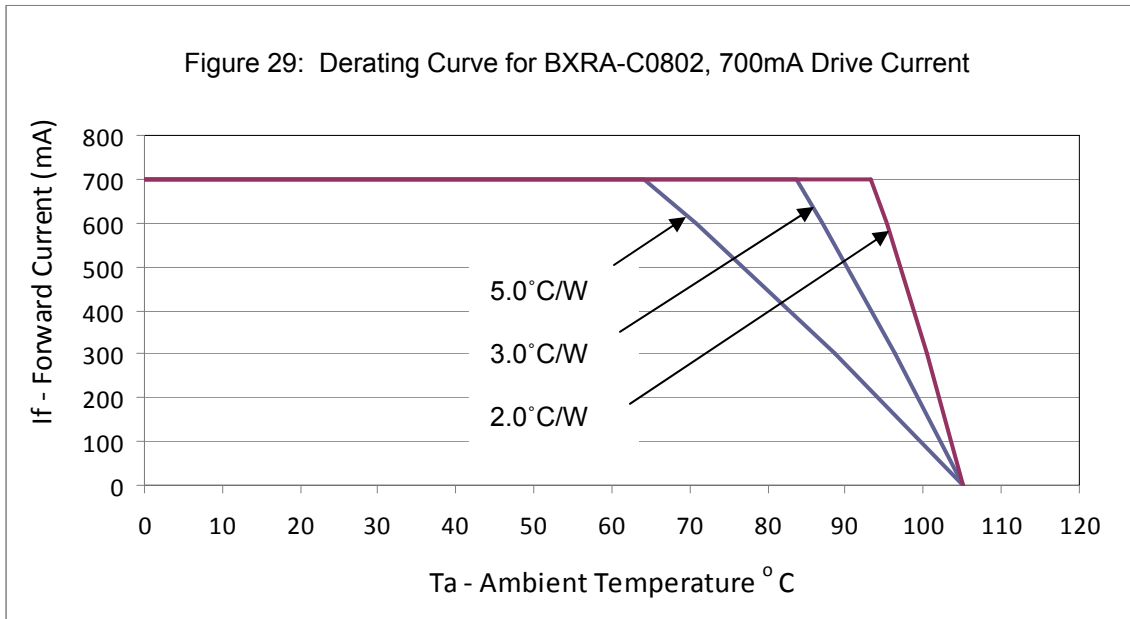

Current Derating Curves (continued)

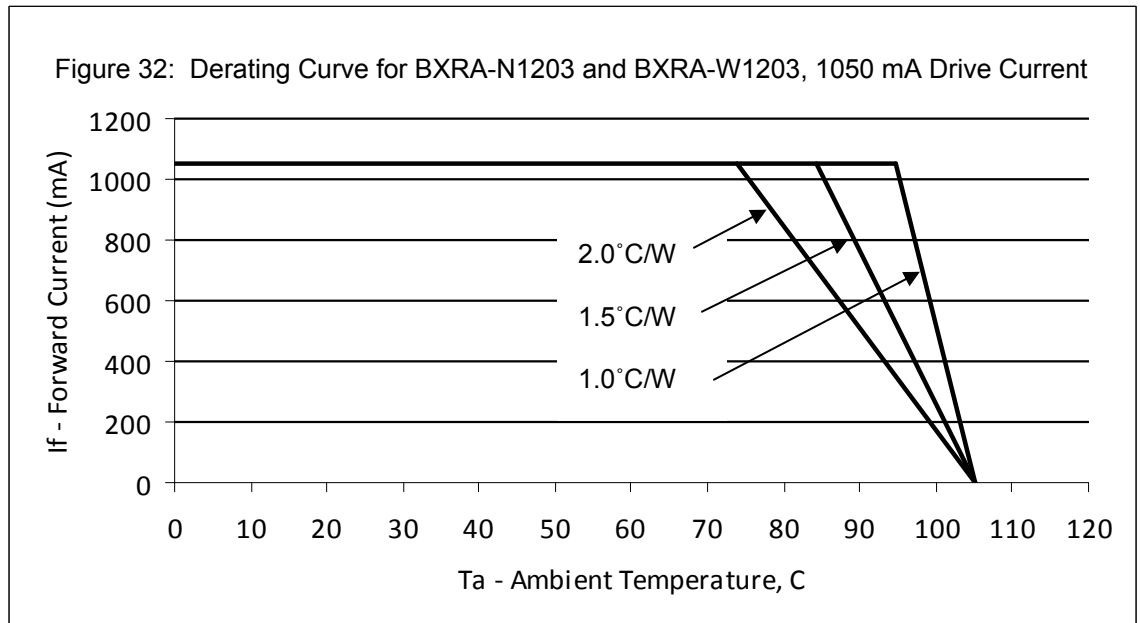
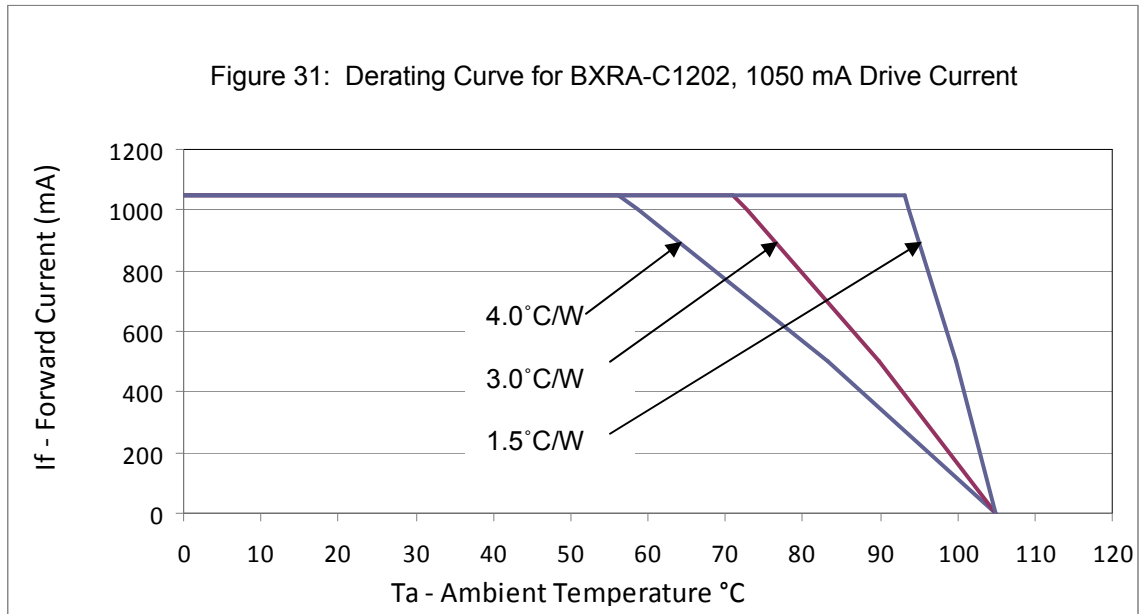

## Current Derating Curves (continued)

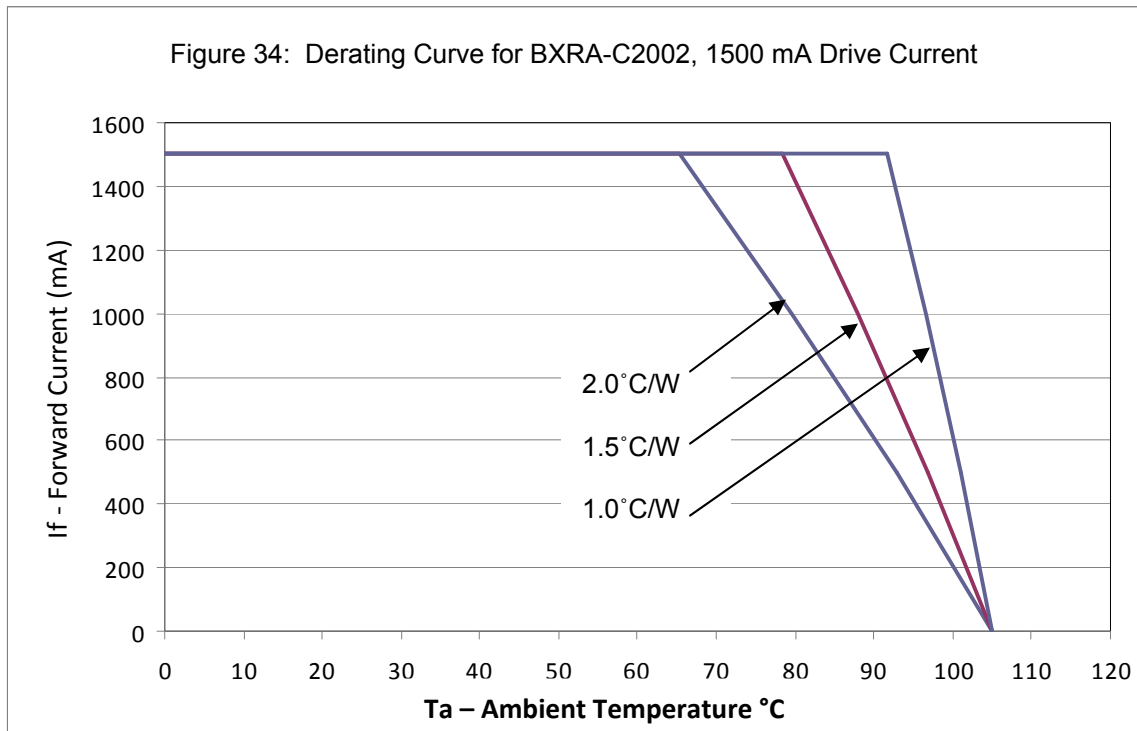
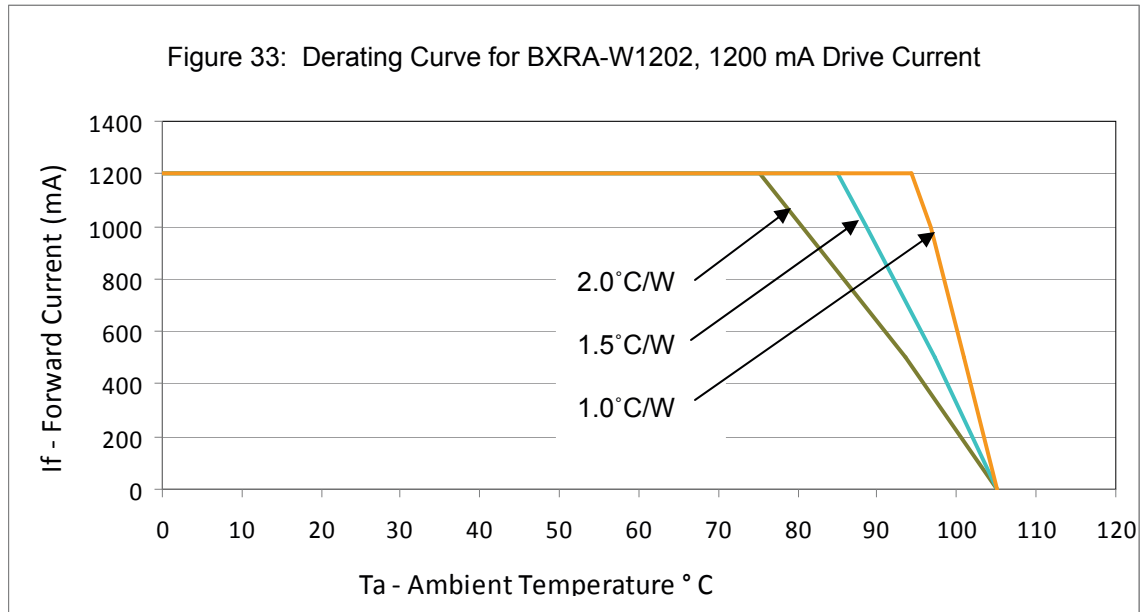

---

## Product Binning

Typical manufacturing processes of semiconductor products result in a variation in performance surrounding the typical data sheet values. In order to minimize variation in the end product or application, Bridgelux bins its LED Arrays for luminous flux and color.

Bridgelux LED Arrays are labeled using a 4-digit alphanumeric bin code. This bin code is printed on the back of each LED Array in the following format:

A B C D

Where:

- A – designates flux bin (P, Q, R etc.)
- B C – designates color bin (P3, P4, Q3, etc.)
- D – reserved for future product designations.

All product packaged within a single tube are of the same flux and color bin combination (or bin code). Using these codes it is possible to determine the best product utilization to deliver the consistency required in a given application.

## Luminous Flux Binning Information

The table below lists the standard photometric luminous flux bins for Bridgelux LED Arrays (tested and binned at the indicated test current). Although several bins are outlined, product availability in a particular bin varies by product and production run. Please contact your Bridgelux sales representative for further information regarding product availability. All production testing and binning (both flux and color binning) is conducted under pulsed test conditions at  $T_j = 25^\circ\text{C}$ .

Table 9: Luminous Flux Bins

Bin Code	Min	Max
C	360 lm	400 lm
D	400 lm	440 lm
E	440 lm	500 lm
F	500 lm	560 lm
G	560 lm	620 lm
H	620 lm	720 lm
J	720 lm	800 lm

Bin Code	Min	Max
K	800 lm	880 lm
L	880 lm	1020 lm
M	1020 lm	1090 lm
N	1090 lm	1200 lm
P	1200 lm	1320 lm
Q	1320 lm	1380 lm
R	1380 lm	1530 lm

Bin Code	Min	Max
S	1530 lm	1740 lm
T	1740 lm	2000 lm
U	2000 lm	2200 lm
V	2200 lm	2450 lm
W	2450 lm	2700 lm
X	2700 lm	3000 lm



## Color Binning Information

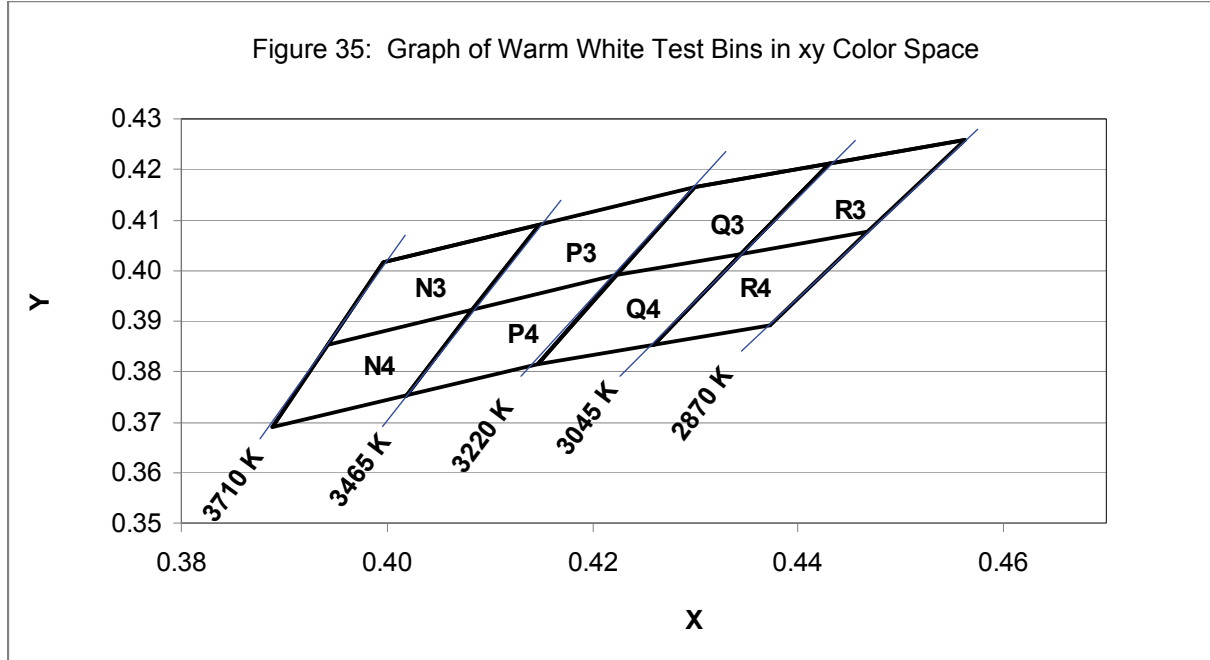

Table 10: Warm White xy Bin Coordinates and Associated Typical CCT

Bin Code	X	Y	ANSI CCT (K)	Bin Code	X	Y	ANSI CCT (K)
N3	0.3943	0.3853	3500	Q3	0.4223	0.3990	3000
	0.3996	0.4015			0.4299	0.4165	
	0.4148	0.4090			0.4431	0.4213	
	0.4083	0.3921			0.4345	0.4033	
N4	0.3889	0.3690	3500	Q4	0.4147	0.3814	3000
	0.3943	0.3853			0.4223	0.3990	
	0.4083	0.3921			0.4345	0.4033	
	0.4018	0.3752			0.4260	0.3854	
P3	0.4083	0.3921	3500	R3	0.4345	0.4033	3000
	0.4148	0.4090			0.4431	0.4213	
	0.4299	0.4165			0.4562	0.4260	
	0.4223	0.3990			0.4468	0.4077	
P4	0.4018	0.3752	3500	R4	0.4260	0.3854	3000
	0.4083	0.3921			0.4345	0.4033	
	0.4223	0.3990			0.4468	0.4077	
	0.4147	0.3814			0.4373	0.3893	

Color Binning Information (continued)

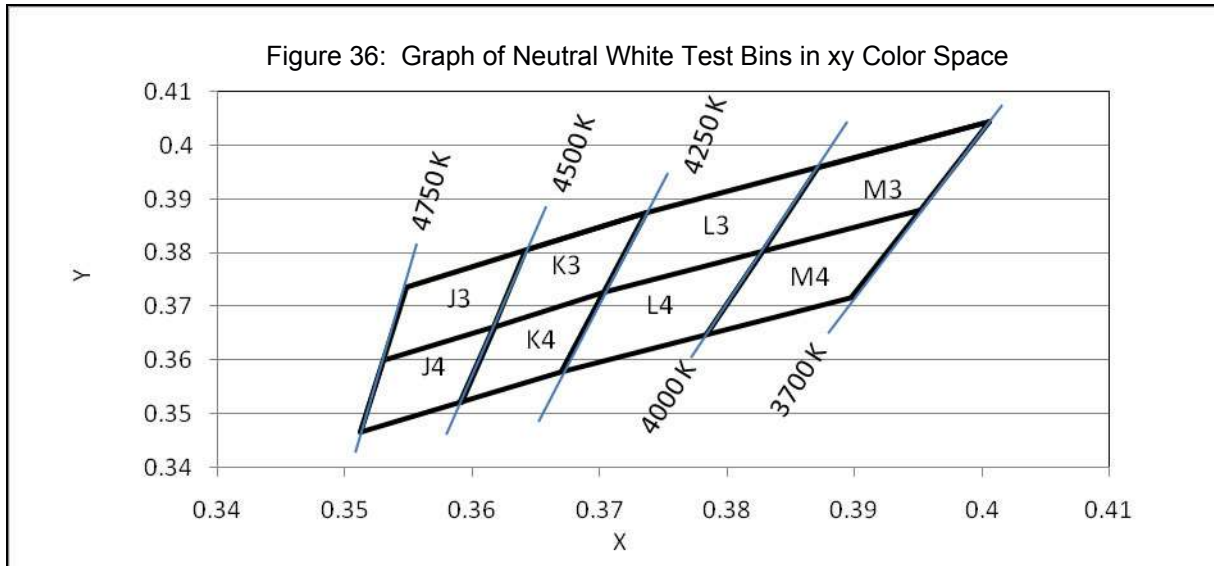

Table 11: Neutral White xy Bin Coordinates and Associated Typical CCT

Bin	X	Y	ANSI CCT (K)	Bin	X	Y	ANSI CCT (K)
J3	0.3530	0.3601	4500	L3	0.3703	0.3726	4000
	0.3548	0.3736			0.3736	0.3874	
	0.3642	0.3805			0.3871	0.3959	
	0.3617	0.3663			0.3828	0.3803	
J4	0.3512	0.3465	4500	L4	0.3670	0.3578	4000
	0.3530	0.3601			0.3703	0.3726	
	0.3617	0.3663			0.3828	0.3803	
	0.3591	0.3522			0.3784	0.3647	
K3	0.3617	0.3663	4500	M3	0.3828	0.3803	4000
	0.3642	0.3805			0.3871	0.3959	
	0.3736	0.3874			0.4006	0.4044	
	0.3703	0.3726			0.3952	0.3880	
K4	0.3591	0.3522	4500	M4	0.3784	0.3647	4000
	0.3617	0.3663			0.3828	0.3803	
	0.3703	0.3726			0.3952	0.3880	
	0.3670	0.3578			0.3898	0.3716	

Color Binning Information (continued)

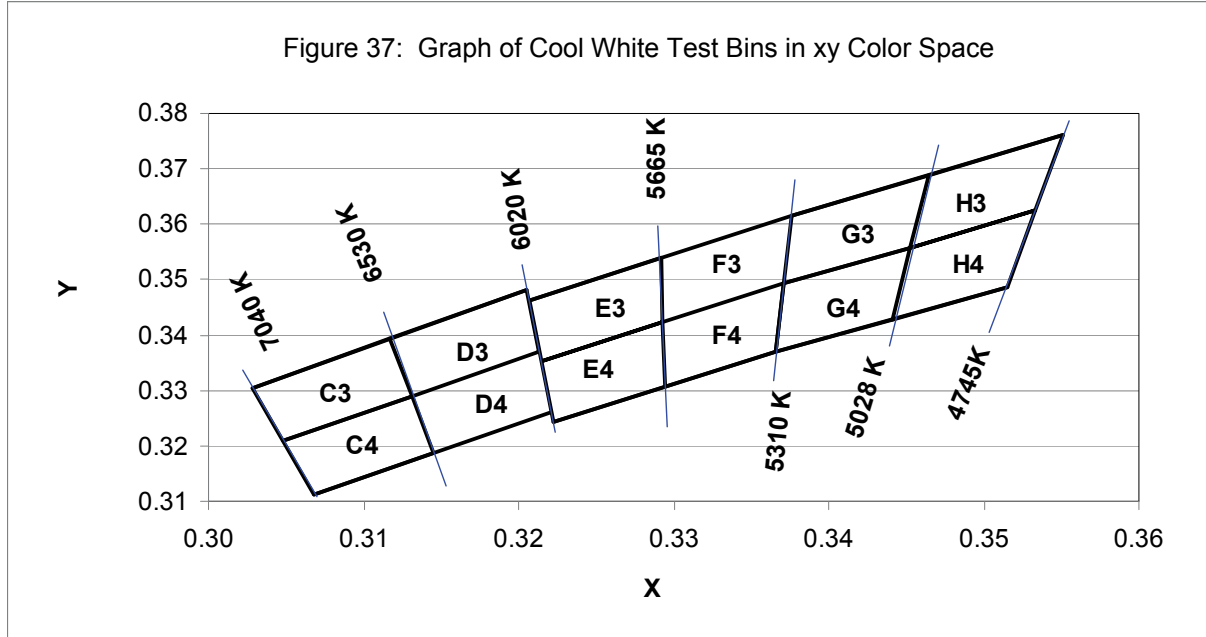

Table 12: Cool White xy Bin Coordinates and Associated Typical CCT

Bin Code	X	Y	ANSI CCT (K)	Bin Code	X	Y	ANSI CCT (K)	Bin Code	X	Y	ANSI CCT (K)
C3	0.3048	0.3209	6500	E3	0.3215	0.3353	5700	G3	0.3376	0.3616	5000
	0.3131	0.3290			0.3293	0.3423			0.3464	0.3688	
	0.3117	0.3393			0.3292	0.3539			0.3452	0.3558	
	0.3028	0.3304			0.3207	0.3462			0.3371	0.3493	
C4	0.3068	0.3113	6500	E4	0.3222	0.3243	5700	G4	0.3371	0.3493	5000
	0.3145	0.3187			0.3294	0.3306			0.3452	0.3558	
	0.3131	0.3290			0.3293	0.3423			0.3441	0.3428	
	0.3048	0.3209			0.3215	0.3353			0.3366	0.3369	
D3	0.3131	0.3290	6500	F3	0.3292	0.3539	5700	H3	0.3464	0.3688	5000
	0.3213	0.3371			0.3293	0.3423			0.3551	0.3760	
	0.3205	0.3481			0.3371	0.3493			0.3533	0.3624	
	0.3117	0.3393			0.3376	0.3616			0.3452	0.3558	
D4	0.3145	0.3187	6500	F4	0.3294	0.3306	5700	H4	0.3452	0.3558	5000
	0.3221	0.3261			0.3366	0.3369			0.3533	0.3624	
	0.3213	0.3371			0.3371	0.3493			0.3515	0.3487	
	0.3131	0.3290			0.3293	0.3423			0.3441	0.3428	

---

## Mechanical Assembly and Handling

Recommended assembly is illustrated below.

When handling parts, please avoid contacting and do not apply stress to the resin area (see Figures 1 and 2, resin area is indicated in yellow).

Product should be firmly secured onto appropriate heat sink by fastening M2.5 or #4 screws on both sides of the product as illustrated in Figure 38. The recommended center-to-center spacing for these the two tapped holes for mounting screws is  $19.20 \pm 0.05\text{mm}$  for hexagonal star products and  $26.92 \pm 0.10\text{mm}$  for rectangular array products. Bridgelux recommends the use of hard non-electrically conductive flat washers with lock washers. Refer to Application Note AN11 – Handling and Assembly of Bridgelux LED Arrays, for more details.

A thin layer of thermal grease should be applied to the bottom surface of the LED Array, between the bottom of the array and the heat sink. All air gaps and voids between the heat sink and array should be eliminated. Ensure that sufficient thermal grease is used to cover the entire bottom surface of the array, but not so much that the thermal grease creeps up to the top of the array.

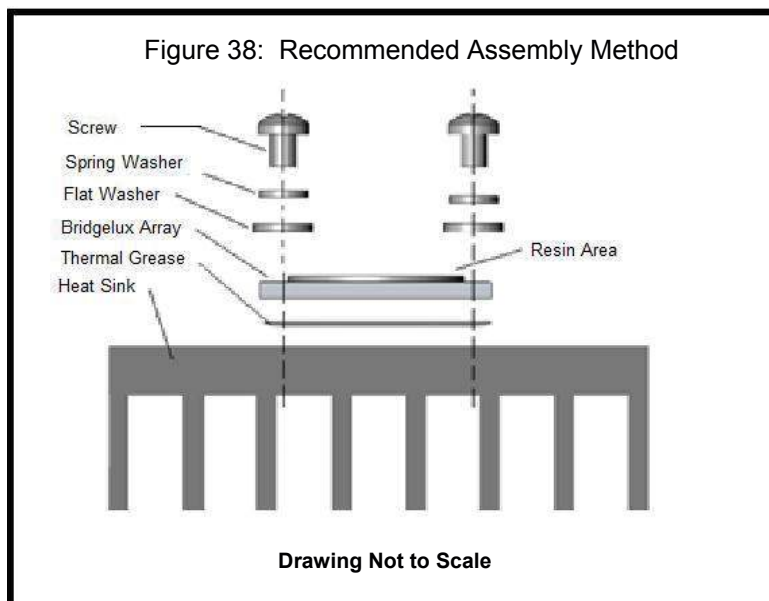

For the hexagonal star products, preferred screw mounting locations are indicated in Figure 39.

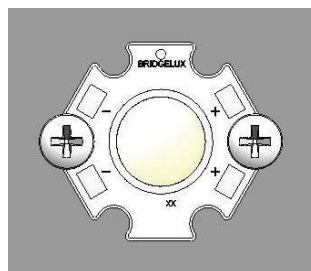

Figure 39: Recommended Mounting Locations for Hexagonal Star Products

---

## Product Packaging and Labeling

All Bridgelux LED Array products are 100% tested, binned and labeled. Products are labeled by printing pertinent information on the back side of the array.

The following format is used for labeling the Bridgelux LED Arrays:

A B C D  
B X R A – x x x x x  
E F G H J – W W Y Y

Where:

A B C D – designates the bin code (LQ30, etc.)

x x x x x – designates the base part number (W0802, etc.)

E F G H J – designates the production lot code (12345, etc.)

W W Y Y – designates the date code (production week and production year, 0210, etc.)

Individual Bridgelux LED Arrays are packaged in tubes for shipment. All product packaged within a single tube are of the same flux and color bin combination (or bin code). Each tube is labeled with the information required for effective inventory management. An example of the tube label is shown in Figure 40.



Figure 40: Tube Label Example

Where:

X X X X X – designates the base part number (W0802, etc.)

A B C D – designates the bin code (LQ30, etc.)

E F G H J – designates the production lot code (12345, etc.)

W W Y Y – designates the date code (production week and production year, 0210, etc.)

Z Z – designates the quantity (25 products per tube for hexagonal stars, 20 for rectangles).

---

## Product Packaging and Labeling (continued)

Tubes of Bridgelux LED Arrays are packaged in bags prior to loading into boxes for shipment. One tube is loaded per bag, resulting in an SPI of 25 for hexagonal star products and 20 for rectangular product configurations. All products packaged within a single bag are of the same flux and color bin combination (or bin code). Each bag is labeled with the information required for effective inventory management. An example of the bag label is shown in Figure 41.



Figure 41: Bag Label Example

Where:

- X X X X X – designates the base part number (W0802, etc.)
- A B C D – designates the bin code (LQ30, etc.)
- E F G H J – designates product lot code
- W W Y Y – designates the date code (production week and production year, 0210, etc.)
- Z Z – designates the quantity (25 products per tube for hexagonal stars, 20 for rectangles).

Bags of Bridgelux LED Arrays are packaged in boxes prior to shipment. Multiple bags are packaged into a box. All products packaged within a box are of the same base part number. Each box is labeled with the information required for effective inventory management. An example of the box label is shown in Figure 42.

---

Product Packaging and Labeling (continued)



Figure 42: Box Label Example

Where:

X X X X X – designates the base part number (W0802, etc.)

R R R R R – used to designate product options, 00000 by default.

Q Q Q – designates the total quantity of LED Arrays contained in the box.

E F G H J – designates product lot code.

A B C D – designates the bin code (LQ30, etc.)

W W Y Y – designates the date code (production week and production year, 0210, etc.)

Z Z Z – designates the quantity per listed bin code contained in the box.

## Packaging Tube Design

Figure 43: Tube Design for Hexagonal Star Products

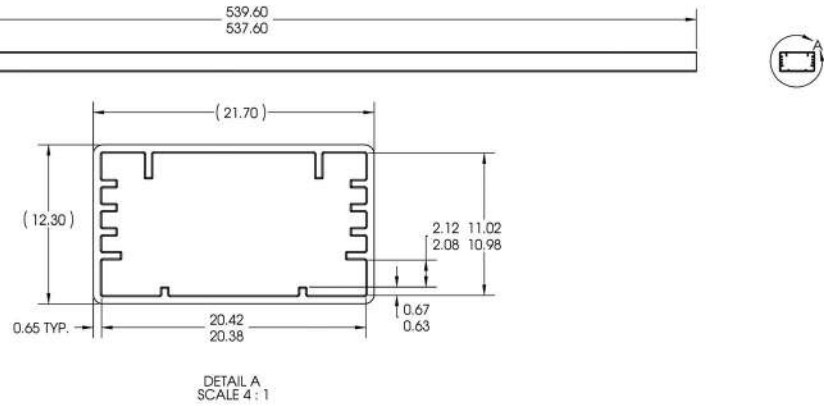
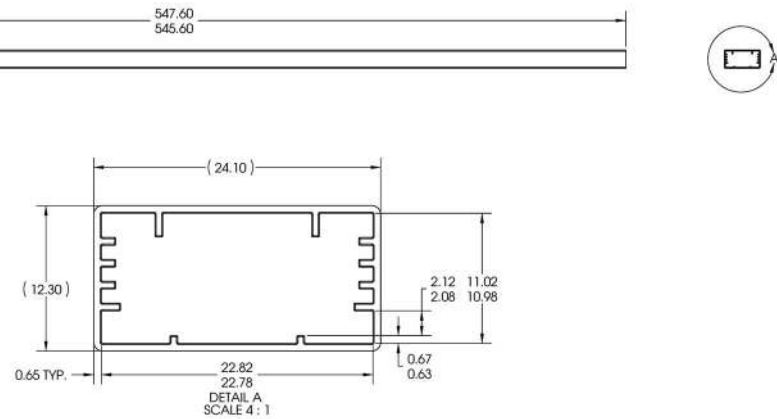

Figure 44: Tube Design for Rectangular Array Products



Notes for Figures 43 and 44:

1. Drawings are not to scale.
2. Drawing dimensions are in millimeters.



---

## Design Resources

Bridgelux has developed a comprehensive set of application notes and design resources to assist customers in successfully designing with Bridgelux LED Array products. Included below is a list of available resources which can be downloaded from the Bridgelux web site under the Design Resources section. These documents are updated regularly as new information becomes available, including complimentary infrastructure products such as commercially available secondary optics and electronic driver solutions.

### Application Notes

- AN10: Effective Thermal Management of Bridgelux LED Arrays
- AN11: Assembly Considerations for Bridgelux LED Arrays
- AN12: Electrical Drive Considerations for Bridgelux LED Arrays
- AN14: Reliability Data Sheet for Bridgelux LED Arrays
- AN15: Reflow Soldering of Bridgelux LED Arrays
- AN16: Optical Considerations for Bridgelux LED Arrays

### Optical Source Models

Optical source models and ray set files are available for all Bridgelux LED Array products, and can be downloaded directly from the Bridgelux web site. The list below contains the formats currently available. If you require a specific format not included in this list, please contact your Bridgelux sales representative for assistance.

- Zemax
- ASAP
- IESNA
- LightTools
- LucidShape
- OPTIS SPEOS
- PHOTOPIA
- TracePro
- Radiant Imaging Source Model

### 3D CAD Models

Three dimensional CAD models depicting the product outline of all Bridgelux LED Arrays are available in both SAT and STEP formats. These CAD files can be downloaded directly from the Bridgelux web site.

---

## About Bridgelux

Bridgelux LED Arrays are developed, manufactured and marketed by Bridgelux, Inc. Bridgelux is a U.S. lighting company and leading developer of technologies and solutions that will transform the \$40 billion global lighting industry into a \$100 billion market opportunity. Based in Silicon Valley, Bridgelux is a pioneer in solid-state lighting (SSL), expanding the market for solid state lighting by driving down the cost of light through innovation. Bridgelux's patented light source technology replaces traditional lighting technologies (such as incandescent, halogen and fluorescent lamps) with integrated, solid-state solutions, enabling lamp and luminaire manufacturers to develop high performance and energy-efficient white light products. The plug and play simplicity of the Bridgelux LED Arrays enable our customers to address the rapidly growing interior and exterior solid state lighting markets, including street lights, retail lighting, commercial lighting and consumer applications. With more than 250 patent applications filed or granted worldwide, Bridgelux is the only vertically integrated LED manufacturer that designs its solutions specifically for the lighting industry.

For more information about the company, please visit [www.bridgelux.com](http://www.bridgelux.com)

© 2010 Bridgelux, Inc. All rights reserved. Product specifications are subject to change without notice.

