

2071566-1 ✓ ACTIVE

SCHRACK | SCHRACK Accessories Miniature Relay PT

TE Internal #: 2071566-1

Relay Accessories, Sockets & Clips, Socket, DIN Rail Mount, Polycarbonate, Miniature Relays PT, SCHRACK Accessories Miniature Relay PT

[View on TE.com >](#)



Relays, Contactors & Switches > Relays > Relay Accessories, Sockets & Clips



Relay Accessory, Socket & Clip Product Type: **Socket**

Relay Accessory, Socket & Clip Socket Type: **DIN Rail Mount**

Grounding Provision: **Without**

Relay Accessory, Socket & Clip Body Material: **Polycarbonate**

Relay Accessory, Socket & Clip For Use With: **Miniature Relays PT**

Features

Product Type Features

| | |
|---------------------------------------------|-----------------|
| Relay Accessory, Socket & Clip Product Type | Socket |
| Relay Accessory Type | DIN Rail Socket |

Configuration Features

| | |
|---------------------|---------|
| Grounding Provision | Without |
|---------------------|---------|

Body Features

| | |
|----------------------------------------------|---------------|
| Relay Accessory, Socket & Clip Body Material | Polycarbonate |
|----------------------------------------------|---------------|

Contact Features

| | |
|--------------------------------------------|----------------|
| Relay Accessory, Socket & Clip Socket Type | DIN Rail Mount |
| Pole Configuration | 4 |

Mechanical Attachment

| | |
|----------------------------------------------|---------------------|
| Relay Accessory, Socket & Clip Mounting Type | DIN Rail Snap Mount |
|----------------------------------------------|---------------------|

Operation/Application

| | |
|---------------------------------------------|---------------------|
| Relay Accessory, Socket & Clip For Use With | Miniature Relays PT |
|---------------------------------------------|---------------------|



Product Compliance

[For compliance documentation, visit the product page on TE.com>](#)

| | |
|-----------------------------------------------|---------------------------------------------------------------------------------------------------------------------------------|
| EU RoHS Directive 2011/65/EU | Compliant |
| EU ELV Directive 2000/53/EC | Compliant |
| China RoHS 2 Directive MIIT Order No 32, 2016 | No Restricted Materials Above Threshold |
| EU REACH Regulation (EC) No. 1907/2006 | Current ECHA Candidate List: JUNE 2023 (235) Candidate List Declared Against: JUNE 2022 (224) Does not contain REACH SVHC |
| Halogen Content | Low Halogen - Br, Cl, F, I < 900 ppm per homogenous material. Also BFR/CFR/PVC Free |
| Solder Process Capability | Not applicable for solder process capability |

















Product Compliance Disclaimer

This information is provided based on reasonable inquiry of our suppliers and represents our current actual knowledge based on the information they provided. This information is subject to change. The part numbers that TE has identified as EU RoHS compliant have a maximum concentration of 0.1% by weight in homogenous materials for lead, hexavalent chromium, mercury, PBB, PBDE, DBP, BBP, DEHP, DIBP, and 0.01% for cadmium, or qualify for an exemption to these limits as defined in the Annexes of Directive 2011/65/EU (RoHS2). Finished electrical and electronic equipment products will be CE marked as required by Directive 2011/65/EU. Components may not be CE marked. Additionally, the part numbers that TE has identified as EU ELV compliant have a maximum concentration of 0.1% by weight in homogenous materials for lead, hexavalent chromium, and mercury, and 0.01% for cadmium, or qualify for an exemption to these limits as defined in the Annexes of Directive 2000/53/EC (ELV). Regarding the REACH Regulation, the information TE provides on SVHC in articles for this part number is based on the latest European Chemicals Agency (ECHA) 'Guidance on requirements for substances in articles' posted at this URL: <https://echa.europa.eu/guidance-documents/guidance-on-reach>

Compatible Parts

| | | | |
|-------------------------------------------------------------------------------------------------------------------------------|-------------------------------------------------------------------------------------------------------------------------------|---------------------------------------------------------------------------------------------------------------------------------|---------------------------------------------------------------------------------------------------------------------------------|
|  <p>TE Part # 5-1415026-1 PT580L24</p> |  <p>TE Part # 9-1419111-0 PT570615</p> |  <p>TE Part # 9-1419111-8 PT571730</p> |  <p>TE Part # 1-1393154-7 PT580024</p> |
|-------------------------------------------------------------------------------------------------------------------------------|-------------------------------------------------------------------------------------------------------------------------------|---------------------------------------------------------------------------------------------------------------------------------|---------------------------------------------------------------------------------------------------------------------------------|



| | | | |
|-------------------------------------------------------------------------------------------------------------------------------|-------------------------------------------------------------------------------------------------------------------------------|---------------------------------------------------------------------------------------------------------------------------------|---------------------------------------------------------------------------------------------------------------------------------|
|  <p>TE Part # 7-1415001-1 PT570R24</p> |  <p>TE Part # 1-1393154-2 PT570024</p> |  <p>TE Part # 9-1419111-1 PT570730</p> |  <p>TE Part # 8-1415001-1 PT570T30</p> |
|  <p>TE Part # 6-1415001-1 PT570L24</p> |  <p>TE Part # 7-1415003-1 PT570S15</p> |  <p>TE Part # 2-1393154-2 PT580730</p> |  <p>TE Part # 7-1415026-1 PT580T30</p> |
|  <p>TE Part # 9-1419111-3 PT571024</p> |  <p>TE Part # 8-1419111-7 PT570524</p> |  <p>TE Part # 7-1415541-0 PT570LC4</p> |  <p>TE Part # 9-1419111-6 PT571524</p> |
|  <p>TE Part # 7-1419135-2 PT581024</p> |  <p>TE Part # 2071566-7 PT28D00</p> |  <p>TE Part # 2071566-9 PT28D01</p> |  <p>TE Part # 6-1415026-1 PT580R24</p> |

Also in the Series | **SCHRACK Accessories Miniature Relay PT**

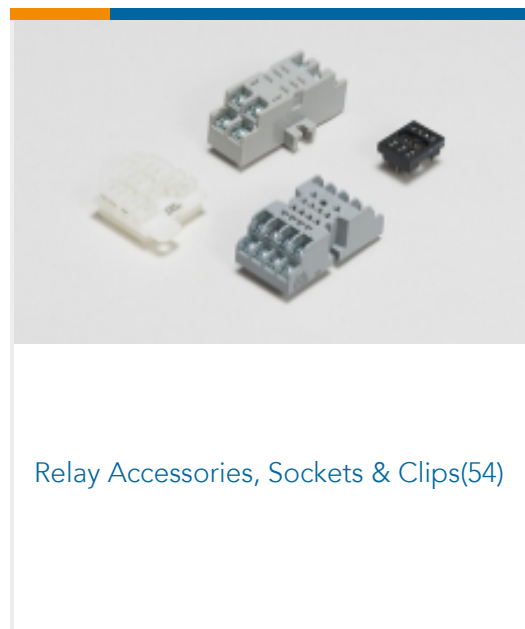

Customers Also Bought



TE Part #206038-1
CPC RECPT ASSEMBLY SIZE 17-28



TE Part #206150-1
CPC PLUG ASSEMBLY SIZE 23-37



TE Part #1-1827864-2
DYNAMIC 1200D REC HSG 4P X
BLACK



TE Part #1827572-2
DYNAMIC D1000 REC CONT 2L AU
0.38um FORM



TE Part #61407-3
187 FASTON TPBR

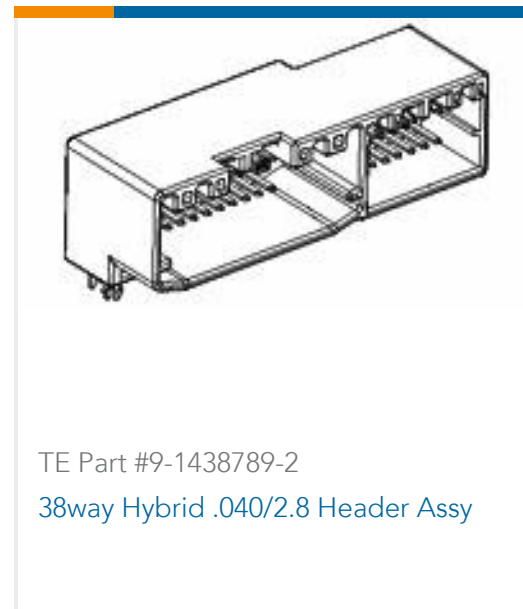

TE Part #9-1438789-2
38way Hybrid .040/2.8 Header Assy



TE Part #1SNL605010R0000
C2.5/5



TE Part #2071566-3
PT78C2P

Documents

Product Drawings

PT78C4P

English

CAD Files

Customer View Model

[ENG_CVM_CVM_2071566-1_1.3d_stp.zip](#)

English

Customer View Model

[ENG_CVM_CVM_2071566-1_1.2d_dxf.zip](#)

English

Customer View Model

[ENG_CVM_CVM_2071566-1_1.3d_igs.zip](#)

English

3D PDF

3D

By downloading the CAD file I accept and agree to the [Terms and Conditions](#) of use.

Datasheets & Catalog Pages

ACCESSORIES FOR MINIATURE RELAY PT

English

Agency Approvals

CE Declaration of Conformity

English