



## GaAs MMIC VOLTAGE-VARIABLE ATTENUATOR, 0.5 - 6.0 GHz

### Typical Applications

The HMC973LP3E is ideal for:

- Point-to-Point Radio
- Cellular/3G & WiMAX/4G Infrastructure
- Test Instrumentation
- Microwave Sensors
- Military, ECM & Radar

### Features

- Excellent Linearity: +35 dBm Input IP3
- Wide Attenuation Range: 26 dB
- Single Positive Voltage Control: 0 to +5V
- Absorptive Topology
- 16 Lead 3x3mm SMT Package: 9mm<sup>2</sup>

### Functional Diagram

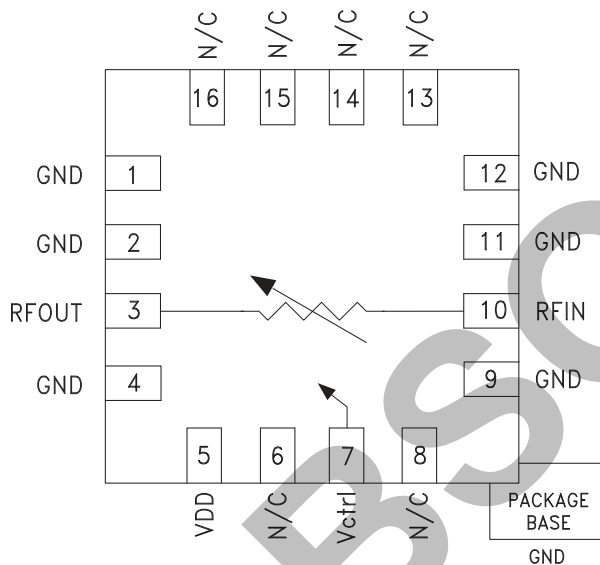

### General Description

The HMC973LP3E is an absorptive Voltage Variable Attenuator (VVA) which operates from 0.5 to 6 GHz and is ideal in designs where an analog DC control signal must be used to control RF signal levels over a 26 dB amplitude range. It features a shunt-type attenuator controlled by an analog voltage, Vctrl. Unlike other GaAs FET based VVA's the HMC973LP3E exhibits excellent linearity of +35 dBm input IP3, throughout its control range. The HMC973LP3E is an unidirectional device with optimum linearity performance achieved when the RF input signal is applied to the RFIN package lead. The HMC973LP3E is housed in a RoHS compliant 3x3 mm QFN leadless package.

### Electrical Specifications, $T_A = +25^\circ\text{C}$ , 50 Ohm system, Vdd = +5V

Parameter	Frequency	Min.	Typ.	Max.	Units
Insertion Loss	0.5 - 4.0 GHz		3.5	5	dB
	4.0 - 6.0 GHz		5.5	8	dB
Attenuation Range	0.5 - 3.0 GHz		26		dB
	3.0 - 6.0 GHz		28		dB
Input Return Loss	0.5 - 6.0 GHz		12		dB
Output Return Loss	0.5 - 6.0 GHz		10		dB
Input Power for 1 dB Compression (any attenuation)	0.5 - 6.0 GHz		30		dBm
Input Third Order Intercept (Two-tone Input Power = +5 dBm Each Tone)	0.5 - 6.0 GHz		35		dBm
Supply Current (Idd)	0.5 - 6.0 GHz		200	300	$\mu\text{A}$

Information furnished by Analog Devices is believed to be accurate and reliable. However, no responsibility is assumed by Analog Devices for its use, nor for any infringements of patents or other rights of third parties that may result from its use. Specifications subject to change without notice. No license is granted by implication or otherwise under any patent or patent rights of Analog Devices. Trademarks and registered trademarks are the property of their respective owners.

For price, delivery, and to place orders: Analog Devices, Inc., One Technology Way, P.O. Box 9106, Norwood, MA 02062-9106 Phone: 781-329-4700 • Order online at [www.analog.com](http://www.analog.com) Application Support: Phone: 1-800-ANALOG-D



**GaAs MMIC VOLTAGE-VARIABLE ATTENUATOR, 0.5 - 6.0 GHz**

**Insertion Loss vs. Frequency Over Temperature**

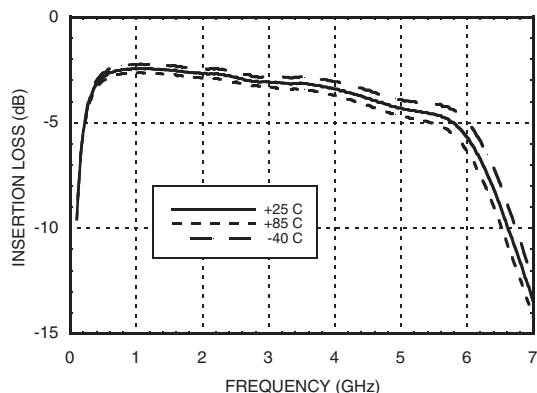

**Attenuation vs. Frequency Over Vctrl**

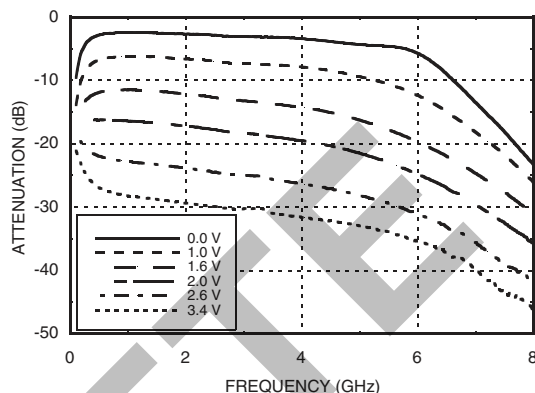

**Attenuation vs. Vctrl Over Temperature @ 0.5 GHz**

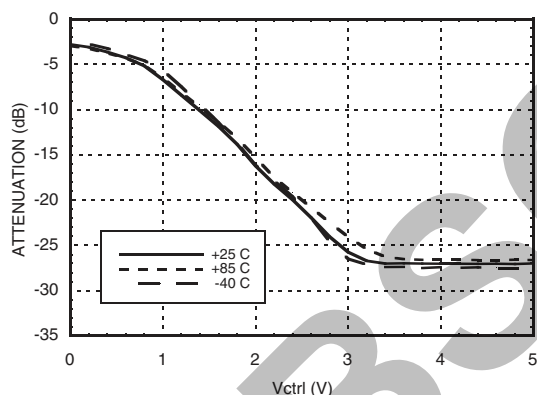

**Attenuation vs. Vctrl Over Temperature @ 2 GHz**

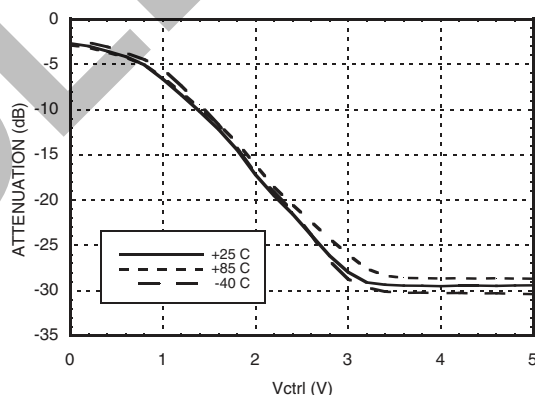

**Attenuation vs. Vctrl Over Temperature @ 4 GHz**

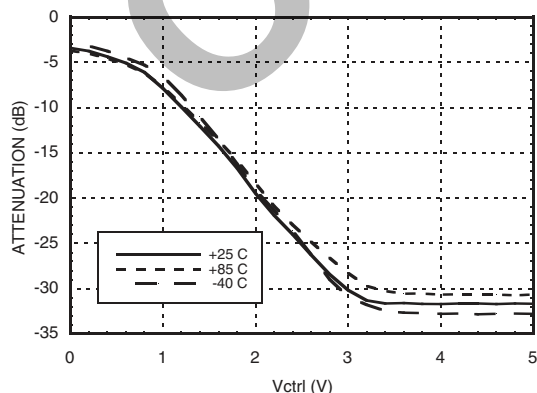

**Attenuation vs. Vctrl Over Temperature @ 6 GHz**

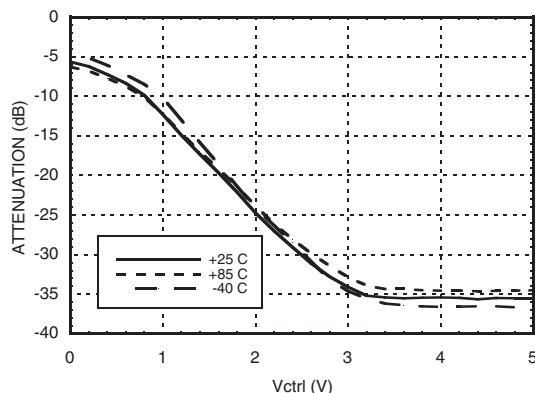

Information furnished by Analog Devices is believed to be accurate and reliable. However, no responsibility is assumed by Analog Devices for its use, nor for any infringements of patents or other rights of third parties that may result from its use. Specifications subject to change without notice. No license is granted by implication or otherwise under any patent or patent rights of Analog Devices. Trademarks and registered trademarks are the property of their respective owners.

For price, delivery, and to place orders: Analog Devices, Inc., One Technology Way, P.O. Box 9106, Norwood, MA 02062-9106 Phone: 781-329-4700 • Order online at [www.analog.com](http://www.analog.com) Application Support: Phone: 1-800-ANALOG-D



**GaAs MMIC VOLTAGE-VARIABLE  
ATTENUATOR, 0.5 - 6.0 GHz**

8

ATTENUATORS - ANALOG - SMT

**Input Return Loss Over Temperature  
(Vctrl = 0)**

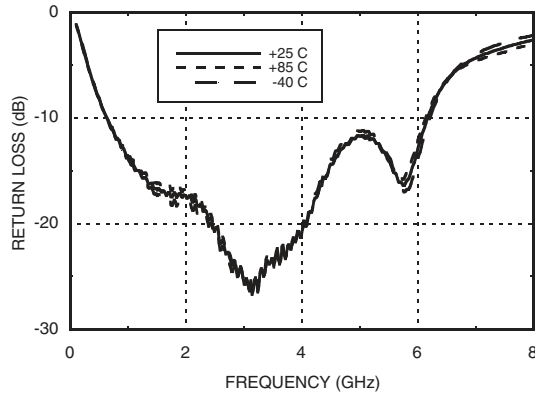

**Input Return Loss Over Vctrl**

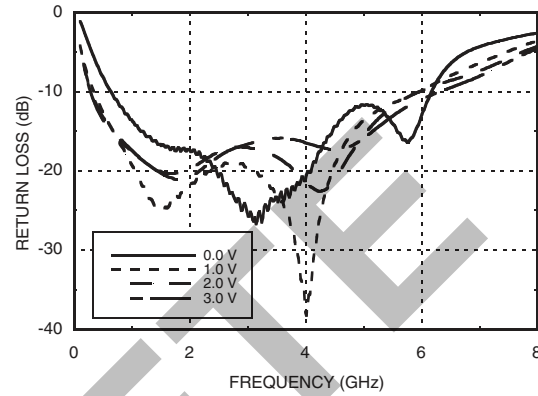

**Output Return Loss Over Temperature  
(Vctrl = 0)**

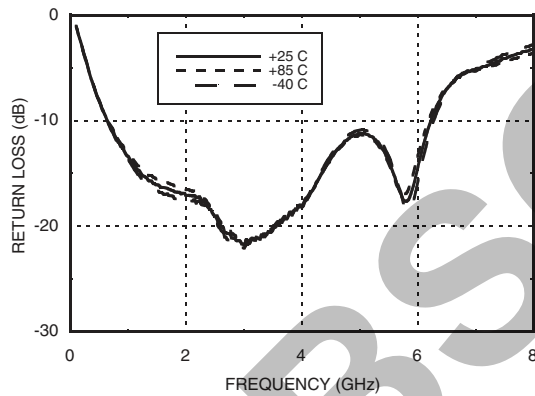

**Output Return Loss Over Vctrl**

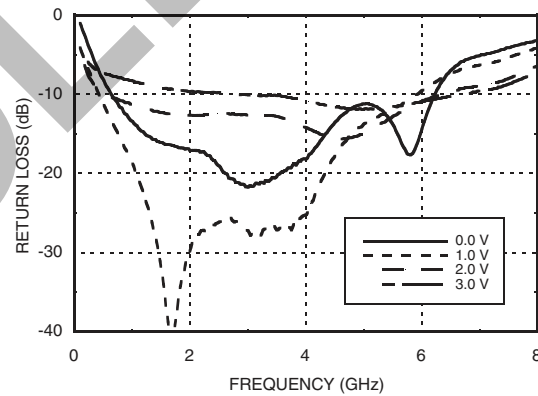

**Input IP3 Over Vctrl**

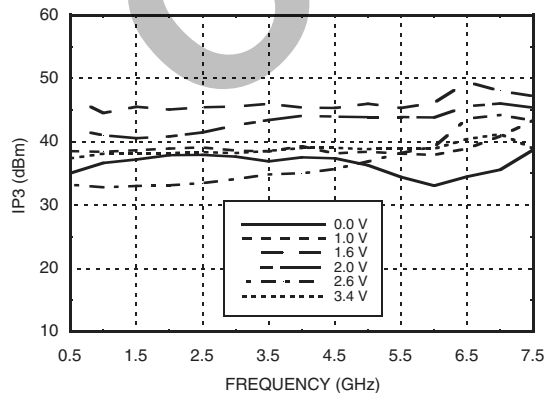

**Input IP3 Over Temperature (Vctrl = 0V)**

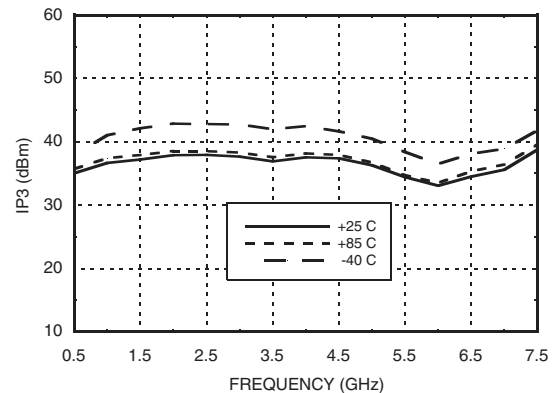

Information furnished by Analog Devices is believed to be accurate and reliable. However, no responsibility is assumed by Analog Devices for its use, nor for any infringements of patents or other rights of third parties that may result from its use. Specifications subject to change without notice. No license is granted by implication or otherwise under any patent or patent rights of Analog Devices. Trademarks and registered trademarks are the property of their respective owners.

For price, delivery, and to place orders: Analog Devices, Inc., One Technology Way, P.O. Box 9106, Norwood, MA 02062-9106 Phone: 781-329-4700 • Order online at [www.analog.com](http://www.analog.com) Application Support: Phone: 1-800-ANALOG-D

## GaAs MMIC VOLTAGE-VARIABLE ATTENUATOR, 0.5 - 6.0 GHz



### Absolute Maximum Ratings

RF Input Power	+29 dBm
Vdd	5.5V
Control Voltage Range	-0.5 to 5.5V
Channel Temperature	150 °C
Continuous P <sub>diss</sub> (T = 85 °C)	0.8W
Thermal Resistance (Channel to ground paddle)	80 °C/W
Storage Temperature	-65 to +150 °C
Operating Temperature	-40 to +85 °C
ESD Sensitivity (HBM)	Class 1A

### Voltages & Currents

Vdd	5V @ 200 μA
Vctrl	0 to +5V @ 100 μA



ELECTROSTATIC SENSITIVE DEVICE  
OBSERVE HANDLING PRECAUTIONS

### Outline Drawing

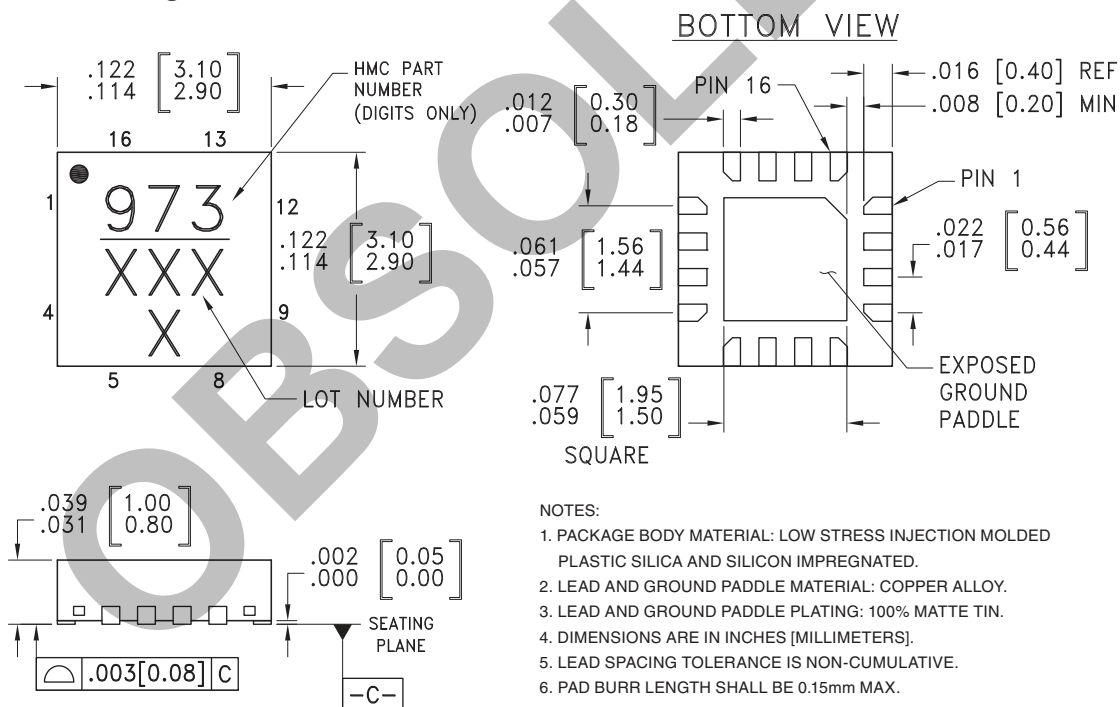

#### NOTES:

1. PACKAGE BODY MATERIAL: LOW STRESS INJECTION MOLDED PLASTIC SILICA AND SILICON IMPREGNATED.
2. LEAD AND GROUND PADDLE MATERIAL: COPPER ALLOY.
3. LEAD AND GROUND PADDLE PLATING: 100% MATTE TIN.
4. DIMENSIONS ARE IN INCHES [MILLIMETERS].
5. LEAD SPACING TOLERANCE IS NON-CUMULATIVE.
6. PAD BURR LENGTH SHALL BE 0.15mm MAX.  
PAD BURR HEIGHT SHALL BE 0.05mm MAX.
7. PACKAGE WARP SHALL NOT EXCEED 0.05mm
8. ALL GROUND LEADS AND GROUND PADDLE MUST BE SOLDERED TO PCB RF GROUND.
9. REFER TO HITTITE APPLICATION NOTE FOR SUGGESTED PCB LAND PATTERN.

### Package Information

Part Number	Package Body Material	Lead Finish	MSL Rating	Package Marking <sup>[1]</sup>
HMC973LP3E	RoHS-compliant Low Stress Injection Molded Plastic	100% matte Sn	MSL1 <sup>[2]</sup>	H973 XXXX

[1] 4-Digit lot number XXXX

[2] Max peak reflow temperature of 260 °C

## GaAs MMIC VOLTAGE-VARIABLE ATTENUATOR, 0.5 - 6.0 GHz



### Pin Descriptions

Pin Number	Function	Description	Interface Schematic
1, 2, 4, 9, 11, 12 Ground Paddle	GND	These pins and the exposed ground paddle must be connected to RF/DC ground.	
3	RFOUT	This pin is DC coupled and matched to 50 Ohms. A blocking capacitor is required if RF line potential is not equal to 0V.	
5	Vdd	Supply Voltage	
6, 8, 13 - 16	N/C	The pins are not connected internally; however, all data shown herein was measured with these pins connected to RF/DC ground externally.	
7	Vctrl	Control Voltage	
10	RFIN	This pin is DC coupled and matched to 50 Ohms. A blocking capacitor is required if RF line potential is not equal to 0V. The HMC973LP3E is a unidirectional device with optimum linearity performance achieved with RF input signal applied to RFIN package lead.	

### Application Circuit

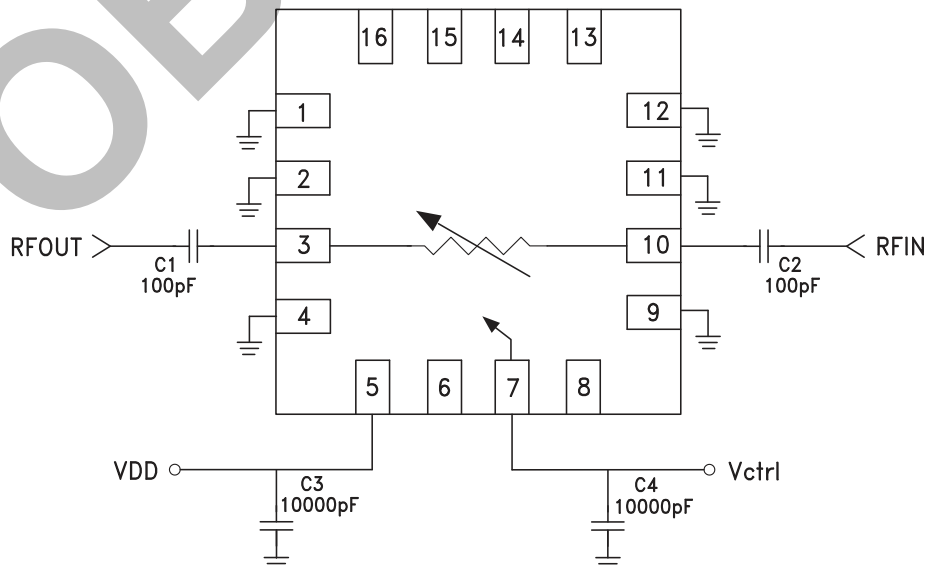

Information furnished by Analog Devices is believed to be accurate and reliable. However, no responsibility is assumed by Analog Devices for its use, nor for any infringements of patents or other rights of third parties that may result from its use. Specifications subject to change without notice. No license is granted by implication or otherwise under any patent or patent rights of Analog Devices. Trademarks and registered trademarks are the property of their respective owners.

For price, delivery, and to place orders: Analog Devices, Inc., One Technology Way, P.O. Box 9106, Norwood, MA 02062-9106 Phone: 781-329-4700 • Order online at [www.analog.com](http://www.analog.com) Application Support: Phone: 1-800-ANALOG-D



**Evaluation PCB**

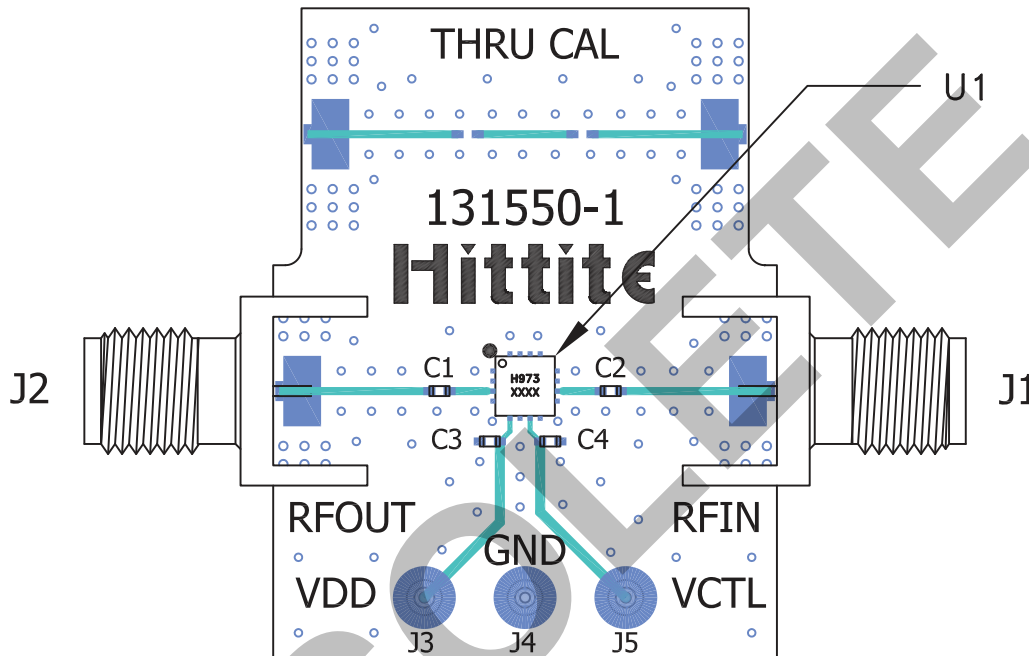

**List of Materials for Evaluation PCB 131552 [1]**

Item	Description
J1, J2	PCB Mount SMA RF Connector
J3 - J5	DC Pin
C1, C2	100 pF Capacitor, 0402 Pkg.
C3, C4	10000 pF Capacitor, 0402 Pkg.
U1	HMC973LP3E Voltage Variable Attenuator
PCB [2]	131550 Evaluation PCB

[1] Reference this number when ordering complete evaluation PCB

[2] Circuit Board Material: Arlon 25FR or Rogers 4350

The circuit board used in the application should use RF circuit design techniques. Signal lines should have 50 Ohm impedance while the package ground leads and exposed paddle should be connected directly to the ground plane similar to that shown. A sufficient number of via holes should be used to connect the top and bottom ground planes. The evaluation circuit board shown is available from Hittite upon request.