

## DRV5056 Unipolar Ratiometric Linear Hall Effect Sensor

### 1 Features

- Unipolar linear hall effect magnetic sensor
- Operates from 3.3-V and 5-V power supplies
- Analog output with 0.6-V quiescent offset:
  - Maximizes voltage swing for high accuracy
- Magnetic sensitivity options (at  $V_{CC} = 5\text{ V}$ ):
  - A1/Z1: 200 mV/mT, 20-mT range
  - A2/Z2: 100 mV/mT, 39-mT range
  - A3/Z3: 50 mV/mT, 79-mT range
  - A4/Z4: 25 mV/mT, 158-mT range
  - A6: 100 mV/mT, 39-mT range
- Fast 20-kHz sensing bandwidth
- Low-noise output with  $\pm 1\text{-mA}$  drive
- Compensation for magnet temperature drift for A1/A2/A3/A4/A6 versions and None for the Z1/Z2/Z3/Z4 versions
- Standard industry packages:
  - Surface-mount SOT-23
  - Through-hole TO-92

### 2 Applications

- Precise position sensing
- Industrial automation and robotics
- Home appliances
- Gamepads, pedals, keyboards, triggers
- Height leveling, tilt and weight measurement
- Fluid flow rate measurement
- Medical devices
- Current sensing

### 3 Description

The DRV5056 is a linear Hall effect sensor that responds proportionally to flux density of a magnetic south pole. The device can be used for accurate position sensing in a wide range of applications.

Featuring a unipolar magnetic response, the analog output drives 0.6 V when no magnetic field is present, and increases when a south magnetic pole is applied. This response maximizes the output dynamic range in applications that sense one magnetic pole. Four sensitivity options further maximize the output swing based on the required sensing range.

The device operates from 3.3-V or 5-V power supplies. Magnetic flux perpendicular to the top of the package is sensed, and the two package options provide different sensing directions.

The device uses a ratiometric architecture that can minimize error from  $V_{CC}$  tolerance when the external analog-to-digital converter (ADC) uses the same  $V_{CC}$  for its reference. Additionally, the device features magnet temperature compensation to counteract how magnets drift for linear performance across a wide temperature range. Device options for no temperature compensation of magnet drift are also available.

The A1 to A4 options support a temperature range of  $-40^{\circ}\text{C}$  to  $+125^{\circ}\text{C}$ . The A6 version supports a temperature range of  $0^{\circ}\text{C}$  to  $85^{\circ}\text{C}$ .

#### Device Information<sup>(1)</sup>

| PART NUMBER | PACKAGE    | BODY SIZE (NOM)   |
|-------------|------------|-------------------|
| DRV5056     | SOT-23 (3) | 2.92 mm × 1.30 mm |
|             | TO-92 (3)  | 4.00 mm × 3.15 mm |

(1) For all available packages, see the package option addendum at the end of the data sheet.

#### Typical Schematic

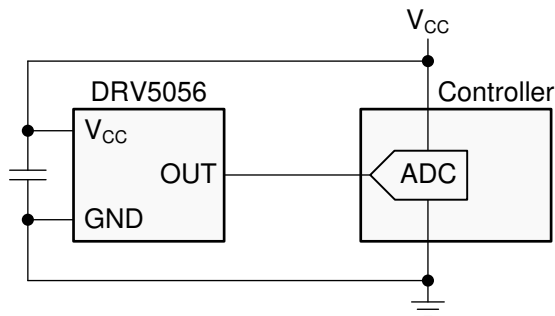

#### Magnetic Response

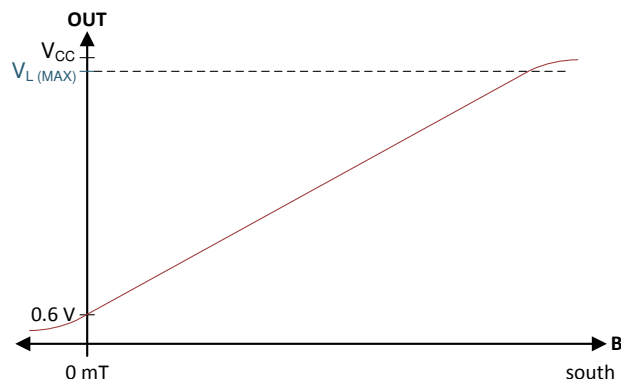

## Table of Contents

|  |    |  |    |
|--|----|--|----|
| <b>1 Features</b> .....                        | 1  | 7.4 Device Functional Modes.....                                 | 15 |
| <b>2 Applications</b> .....                    | 1  | <b>8 Application and Implementation</b> .....                    | 16 |
| <b>3 Description</b> .....                     | 1  | 8.1 Application Information.....                                 | 16 |
| <b>4 Revision History</b> .....                | 2  | 8.2 Typical Application .....                                    | 17 |
| <b>5 Pin Configuration and Functions</b> ..... | 3  | 8.3 What to Do and What Not to Do .....                          | 19 |
| <b>6 Specifications</b> .....                  | 3  | <b>9 Power Supply Recommendations</b> .....                      | 21 |
| 6.1 Absolute Maximum Ratings .....             | 3  | <b>10 Layout</b> .....   | 21 |
| 6.2 ESD Ratings.....                           | 4  | 10.1 Layout Guidelines .....                                     | 21 |
| 6.3 Recommended Operating Conditions.....      | 4  | 10.2 Layout Examples.....  | 21 |
| 6.4 Thermal Information .....                  | 4  | <b>11 Device and Documentation Support</b> .....                 | 22 |
| 6.5 Electrical Characteristics.....            | 4  | 11.1 Documentation Support .....                                 | 22 |
| 6.6 Magnetic Characteristics.....              | 5  | 11.2 Receiving Notification of Documentation Updates .....       | 22 |
| 6.7 Typical Characteristics .....              | 6  | 11.3 Community Resources.....                                    | 22 |
| <b>7 Detailed Description</b> .....            | 11 | 11.4 Trademarks .....  | 22 |
| 7.1 Overview .....                             | 11 | 11.5 Electrostatic Discharge Caution.....                        | 22 |
| 7.2 Functional Block Diagram .....             | 11 | 11.6 Glossary .....  | 22 |
| 7.3 Feature Description.....                   | 11 | <b>12 Mechanical, Packaging, and Orderable Information</b> ..... | 22 |

## 4 Revision History

NOTE: Page numbers for previous revisions may differ from page numbers in the current version.

| Changes from Original (February 2019) to Revision B  | Page |
|--|------|
| • Added Zero TC sensitivity options .....  | 1    |
| • Added Zero TC information to Recommended Operating Conditions section .....                          | 4    |
| • Added Zero TC information to Electrical Characteristics .....  | 4    |
| • Added Zero TC information to Magnetic Characteristics .....  | 5    |
| • Added graphs for DRV5056Z1/Z2/Z3/Z4 options in the <i>Typical Characteristics</i> section .....      | 6    |
| • Updated $S_{TC}$ definition in <a href="#">Equation 1</a> .....                                      | 12   |
| • Updated the <i>Sensitivity Temperature Compensation For Magnets</i> section for Zero TC options..... | 14   |

| Changes from Original (April 2018) to Revision A                  | Page |
|---|------|
| • Added new A6 magnetic sensitivity option to the data sheet..... | 1    |

## 5 Pin Configuration and Functions

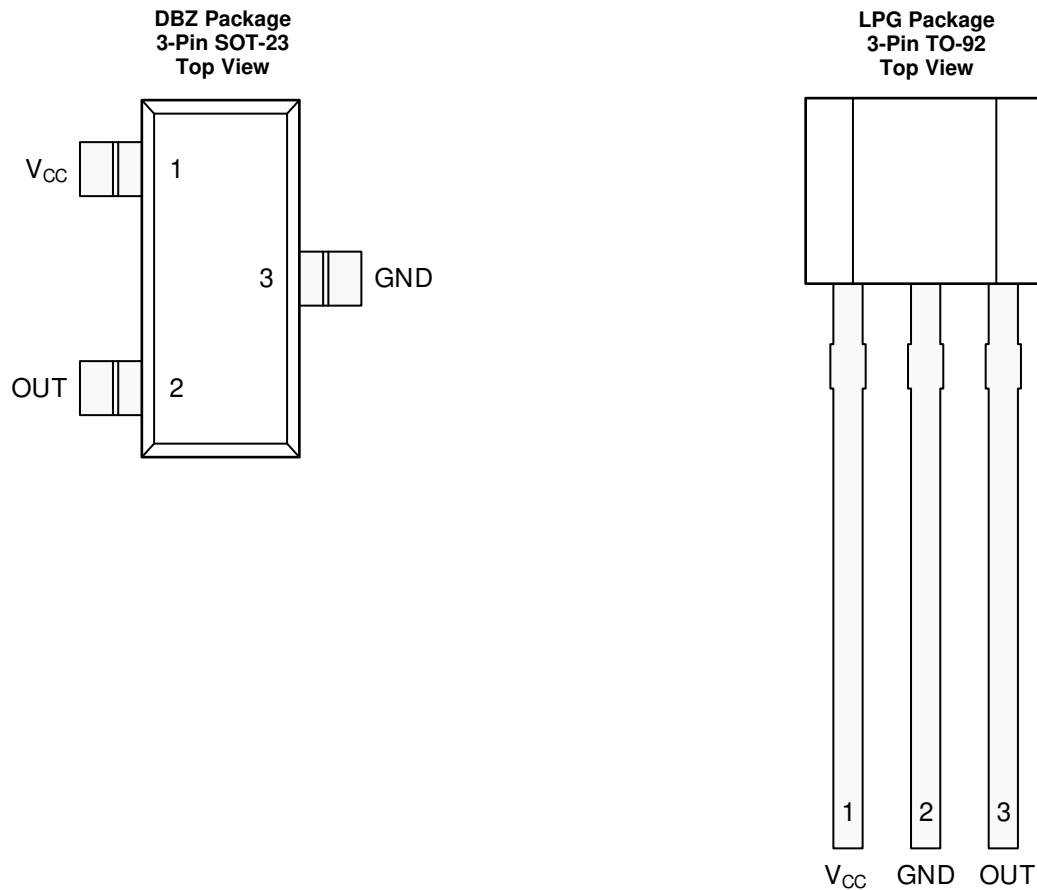

### Pin Functions

| NAME            | PIN    |       | I/O | DESCRIPTION  |
|-----------------|--------|-------|-----|--|
|                 | SOT-23 | TO-92 |     |  |
| GND             | 3      | 2     | —   | Ground reference   |
| OUT             | 2      | 3     | O   | Analog output  |
| V <sub>CC</sub> | 1      | 1     | —   | Power supply. TI recommends connecting this pin to a ceramic capacitor to ground with a value of at least 0.1 $\mu$ F. |

## 6 Specifications

### 6.1 Absolute Maximum Ratings

over operating free-air temperature range (unless otherwise noted)<sup>(1)</sup>

|  |                 | MIN       | MAX                   | UNIT |
|--|-----------------|-----------|-----------------------|------|
| Power supply voltage                           | V <sub>CC</sub> | -0.3      | 7                     | V    |
| Output voltage                                 | OUT             | -0.3      | V <sub>CC</sub> + 0.3 | V    |
| Magnetic flux density, B <sub>MAX</sub>        |                 | Unlimited |                       | T    |
| Operating junction temperature, T <sub>J</sub> |                 | -40       | 150                   | °C   |
| Storage temperature, T <sub>stg</sub>          |                 | -65       | 150                   | °C   |

(1) Stresses beyond those listed under *Absolute Maximum Ratings* may cause permanent damage to the device. These are stress ratings only, which do not imply functional operation of the device at these or any other conditions beyond those indicated under *Recommended Operating Conditions*. Exposure to absolute-maximum-rated conditions for extended periods may affect device reliability.

## 6.2 ESD Ratings

|                    |                         |  | VALUE | UNIT |
|--------------------|-------------------------|--|-------|------|
| V <sub>(ESD)</sub> | Electrostatic discharge | Human-body model (HBM), per ANSI/ESDA/JEDEC JS-001 <sup>(1)</sup>              | ±2500 | V    |
|                    |                         | Charged-device model (CDM), per JEDEC specification JESD22-C101 <sup>(2)</sup> | ±750  |      |

(1) JEDEC document JEP155 states that 500-V HBM allows safe manufacturing with a standard ESD control process.

(2) JEDEC document JEP157 states that 250-V CDM allows safe manufacturing with a standard ESD control process.

## 6.3 Recommended Operating Conditions

over operating free-air temperature range (unless otherwise noted)

|                 |   | MIN | MAX | UNIT |
|-----------------|---|-----|-----|------|
| V <sub>CC</sub> | Power supply voltage <sup>(1)</sup>                               | 3   | 3.6 | V    |
|                 |   | 4.5 | 5.5 |      |
| I <sub>O</sub>  | Output continuous current   | –1  | 1   | mA   |
| T <sub>A</sub>  | A1/Z1-A4/Z4 versions operating ambient temperature <sup>(2)</sup> | –40 | 125 | °C   |
| T <sub>A</sub>  | A6 version operating ambient temperature <sup>(2)</sup>           | 0   | 85  | °C   |

(1) There are two isolated operating V<sub>CC</sub> ranges. For more information see the [Operating V<sub>CC</sub> Ranges](#) section.

(2) Power dissipation and thermal limits must be observed.

## 6.4 Thermal Information

| THERMAL METRIC <sup>(1)</sup> |  | DRV5056      |             | UNIT |
|-------------------------------|--|--------------|-------------|------|
|                               |  | SOT-23 (DBZ) | TO-92 (LPG) |      |
|                               |  | 3 PINS       | 3 PINS      |      |
| R <sub>θJA</sub>              | Junction-to-ambient thermal resistance       | 170          | 121         | °C/W |
| R <sub>θJC(top)</sub>         | Junction-to-case (top) thermal resistance    | 66           | 67          | °C/W |
| R <sub>θJB</sub>              | Junction-to-board thermal resistance         | 49           | 97          | °C/W |
| Y <sub>JT</sub>               | Junction-to-top characterization parameter   | 1.7          | 7.6         | °C/W |
| Y <sub>JB</sub>               | Junction-to-board characterization parameter | 48           | 97          | °C/W |

(1) For more information about traditional and new thermal metrics, see the [Semiconductor and IC Package Thermal Metrics](#) application report.

## 6.5 Electrical Characteristics

for V<sub>CC</sub> = 3 V to 3.63 V and 4.5 V to 5.5 V, over operating free-air temperature range (unless otherwise noted)

| PARAMETER       |  | TEST CONDITIONS <sup>(1)</sup>    |                            | MIN | TYP  | MAX | UNIT             |
|-----------------|--|-----------------------------------|----------------------------|-----|------|-----|------------------|
| I <sub>CC</sub> | Operating supply current                       |                                   |                            |     | 6    | 10  | mA               |
| t <sub>ON</sub> | Power-on time (see <a href="#">Figure 30</a> ) | B = 0 mT, no load on OUT          |                            |     | 150  | 300 | μs               |
| f <sub>BW</sub> | Sensing bandwidth                              |                                   |                            |     | 20   |     | kHz              |
| t <sub>d</sub>  | Propagation delay time                         | From change in B to change in OUT |                            |     | 10   |     | μs               |
| B <sub>ND</sub> | Input-referred RMS noise density               | V <sub>CC</sub> = 5 V             |                            |     | 130  |     | nT/√Hz           |
|                 |  | V <sub>CC</sub> = 3.3 V           |                            |     | 215  |     |                  |
| B <sub>N</sub>  | Input-referred noise                           | B <sub>ND</sub> × 6.6 × √20 kHz   | V <sub>CC</sub> = 5 V      |     | 0.12 |     | mT <sub>PP</sub> |
|                 |  |                                   | V <sub>CC</sub> = 3.3 V    |     | 0.2  |     |                  |
| V <sub>N</sub>  | Output-referred noise <sup>(2)</sup>           | B <sub>N</sub> × S                | DRV5056A1/Z1               |     | 24   |     | mV <sub>PP</sub> |
|                 |  |                                   | DRV5056A2/Z2,<br>DRV5056A6 |     | 12   |     |                  |
|                 |  |                                   | DRV5056A3/Z3               |     | 6    |     |                  |
|                 |  |                                   | DRV5056A4/Z4               |     | 3    |     |                  |

(1) B is the applied magnetic flux density.

(2) V<sub>N</sub> describes voltage noise on the device output. If the full device bandwidth is not needed, noise can be reduced with an RC filter.

## 6.6 Magnetic Characteristics

for  $V_{CC} = 3\text{ V to }3.63\text{ V}$  and  $4.5\text{ V to }5.5\text{ V}$ , over operating free-air temperature range (unless otherwise noted)

| PARAMETER       |   | TEST CONDITIONS <sup>(1)</sup>   |                               | MIN    | TYP            | MAX   | UNIT  |
|-----------------|---|--|-------------------------------|--------|----------------|-------|-------|
| $V_Q$           | Quiescent voltage   | $B = 0\text{ mT}$ , $T_A = 25^\circ\text{C}$   | DRV5056A1/Z1                  | 0.535  | 0.6            | 0.665 | V     |
|                 |   |  | DRV5056A2/Z2,<br>DRV5056A6    | 0.54   | 0.6            | 0.66  |       |
|                 |   |  | DRV5056A3/Z3,<br>DRV5056A4/Z4 | 0.55   | 0.6            | 0.65  |       |
| $V_{Q\Delta T}$ | Quiescent voltage temperature drift                             | $B = 0\text{ mT}$ ,<br>$T_A = -40^\circ\text{C to }125^\circ\text{C}$<br>versus $25^\circ\text{C}$ | $V_{CC} = 5\text{ V}$         | 0.08   |                | V     |       |
|                 |   |  | $V_{CC} = 3.3\text{ V}$       | 0.04   |                |       |       |
| $V_{Q\Delta L}$ | Quiescent voltage lifetime drift                                | High-temperature operating stress for 1000 hours   |                               | < 0.5% |                |       |       |
| S               | Sensitivity   | $V_{CC} = 5\text{ V}$ ,<br>$T_A = 25^\circ\text{C}$  | DRV5056A1/Z1                  | 190    | 200            | 210   | mV/mT |
|                 |   |  | DRV5056A2/Z2,<br>DRV5056A6    | 95     | 100            | 105   |       |
|                 |   |  | DRV5056A3/Z3                  | 47.5   | 50             | 52.5  |       |
|                 |   |  | DRV5056A4/Z4                  | 23.8   | 25             | 26.2  |       |
|                 |   | $V_{CC} = 3.3\text{ V}$ ,<br>$T_A = 25^\circ\text{C}$  | DRV5056A1/Z1                  | 114    | 120            | 126   |       |
|                 |   |  | DRV5056A2/Z2,<br>DRV5056A6    | 57     | 60             | 63    |       |
|                 |   |  | DRV5056A3/Z3                  | 28.5   | 30             | 31.5  |       |
|                 |   |  | DRV5056A4/Z4                  | 14.3   | 15             | 15.8  |       |
| $B_L$           | Linear magnetic sensing range <sup>(2)</sup>                    | $V_{CC} = 5\text{ V}$ ,<br>$T_A = 25^\circ\text{C}$  | DRV5056A1/Z1                  | 20     |                |       | mT    |
|                 |   |  | DRV5056A2/Z2,<br>DRV5056A6    | 39     |                |       |       |
|                 |   |  | DRV5056A3/Z3                  | 79     |                |       |       |
|                 |   |  | DRV5056A4/Z4                  | 158    |                |       |       |
|                 |   | $V_{CC} = 3.3\text{ V}$ ,<br>$T_A = 25^\circ\text{C}$  | DRV5056A1/Z1                  | 19     |                |       |       |
|                 |   |  | DRV5056A2/Z2,<br>DRV5056A6    | 39     |                |       |       |
|                 |   |  | DRV5056A3/Z3                  | 78     |                |       |       |
|                 |   |  | DRV5056A4/Z4                  | 155    |                |       |       |
| $V_L$           | Linear range of output voltage <sup>(3)</sup>                   |  | $V_Q$                         |        | $V_{CC} - 0.2$ | V     |       |
| $S_{TC}$        | Sensitivity temperature compensation for magnets <sup>(4)</sup> | DRV5056A6  | 0.05                          | 0.12   | 0.19           | %/°C  |       |
| $S_{TC}$        | Sensitivity temperature compensation for magnets <sup>(4)</sup> | DRV5056A1, DRV5056A2, DRV5056A3,<br>DRV5056A4  |                               | 0.12   |                | %/°C  |       |
| $S_{TCz}$       | Sensitivity temperature compensation for magnets <sup>(4)</sup> | DRV5056Z1, DRV5056Z2, DRV5056Z3,<br>DRV5056Z4  |                               | 0      |                | %/°C  |       |
| $S_{LE}$        | Sensitivity linearity error <sup>(3)</sup>                      | $V_{OUT}$ is within $V_L$  |                               | ±1%    |                |       |       |
| $S_{RE}$        | Sensitivity ratiometry error <sup>(5)</sup>                     | $T_A = 25^\circ\text{C}$ ,<br>with respect to $V_{CC} = 3.3\text{ V}$ or $5\text{ V}$              | -2.5%                         |        | 2.5%           |       |       |
| $S_{\Delta L}$  | Sensitivity lifetime drift                                      | High-temperature operating stress for 1000 hours   |                               | < 0.5% |                |       |       |

(1) B is the applied magnetic flux density.

(2)  $B_L$  describes the minimum linear sensing range at  $25^\circ\text{C}$  taking into account the maximum  $V_Q$  and Sensitivity tolerances.

(3) See the [Sensitivity Linearity](#) section.

(4)  $S_{TC}$  describes the rate the device increases Sensitivity with temperature. For more information, see the [Sensitivity Temperature Compensation For Magnets](#) section.

(5) See the [Ratiometric Architecture](#) section.

## 6.7 Typical Characteristics

at  $T_A = 25^\circ\text{C}$  (unless otherwise noted)

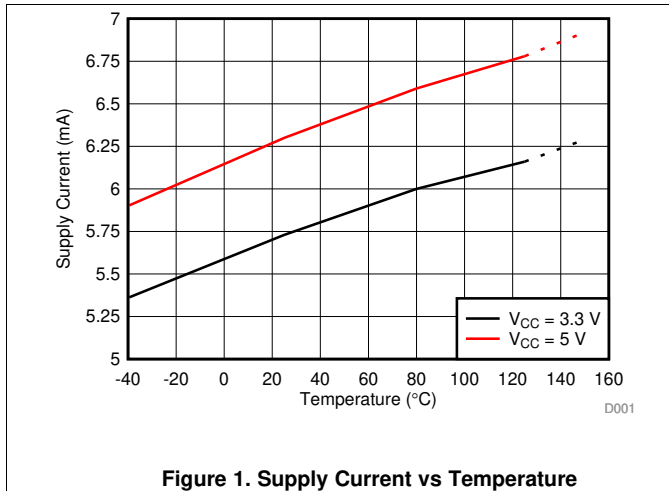

Figure 1. Supply Current vs Temperature

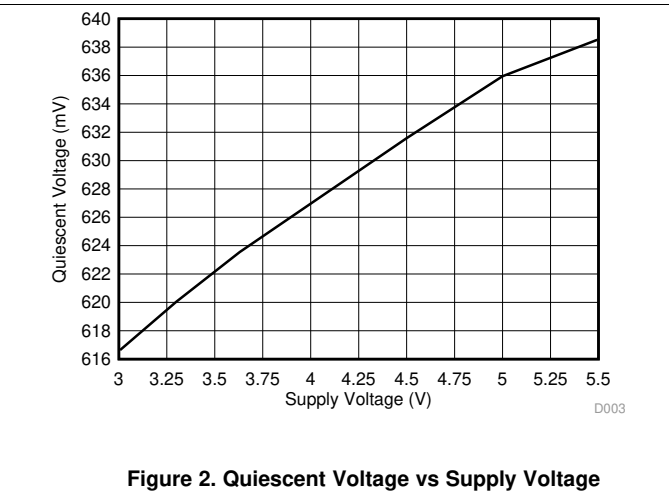

Figure 2. Quiescent Voltage vs Supply Voltage

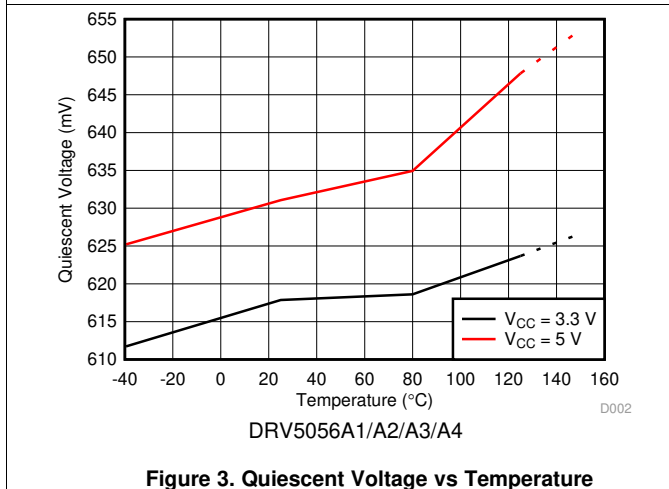

Figure 3. Quiescent Voltage vs Temperature

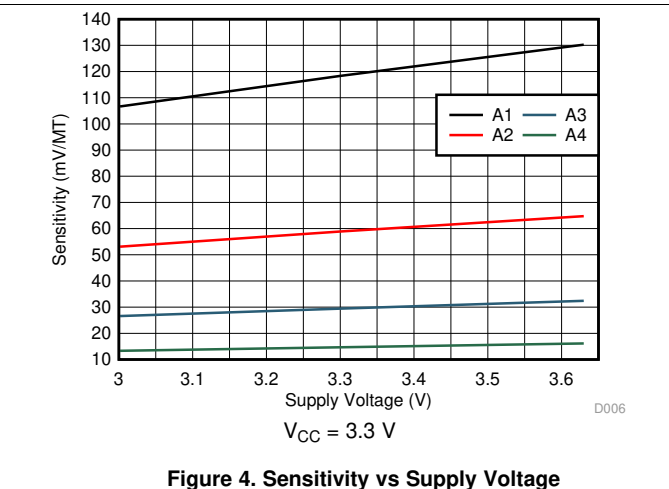

Figure 4. Sensitivity vs Supply Voltage

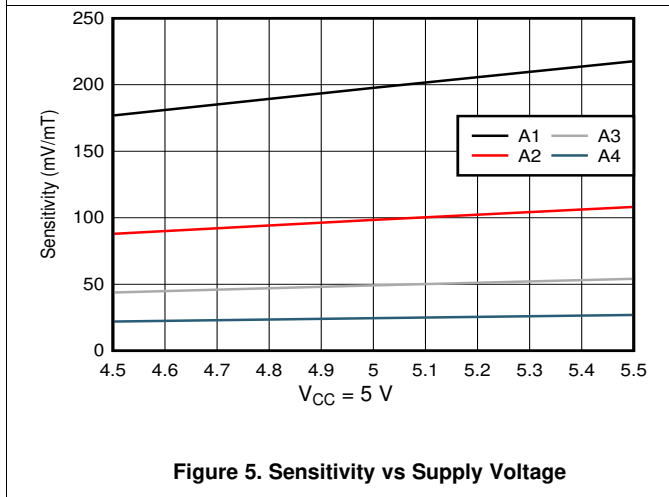

Figure 5. Sensitivity vs Supply Voltage

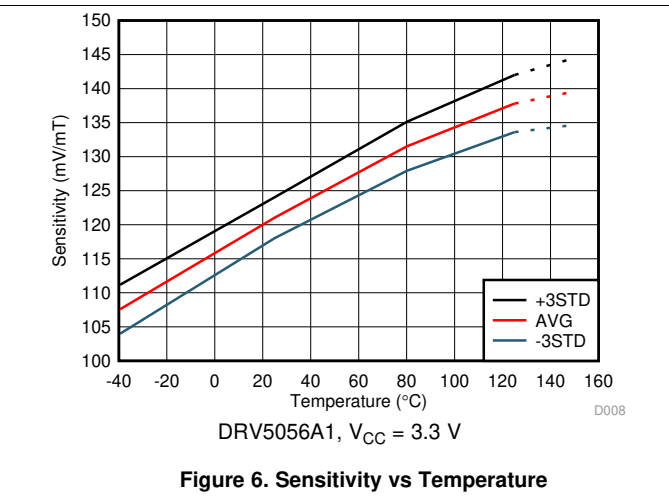

Figure 6. Sensitivity vs Temperature

Typical Characteristics (continued)

at  $T_A = 25^\circ\text{C}$  (unless otherwise noted)

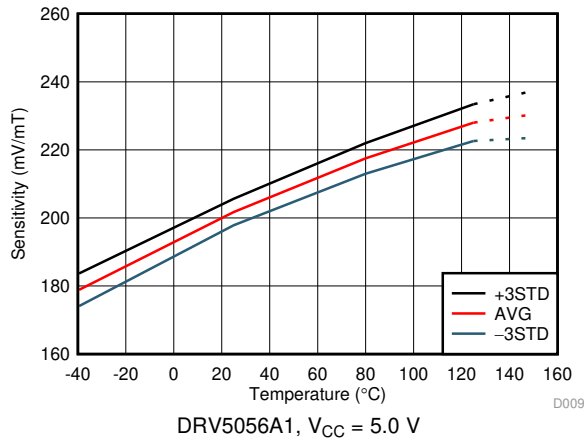

Figure 7. Sensitivity vs Temperature

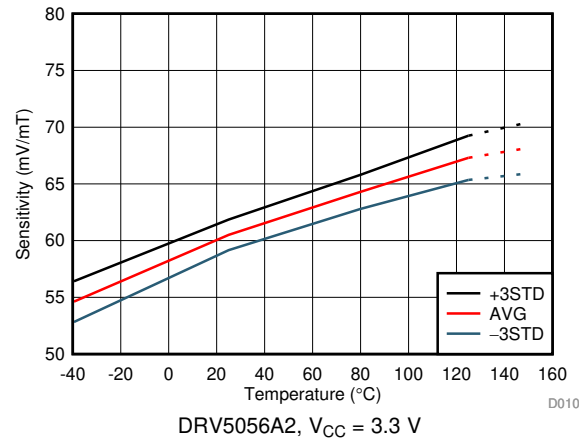

Figure 8. Sensitivity vs Temperature

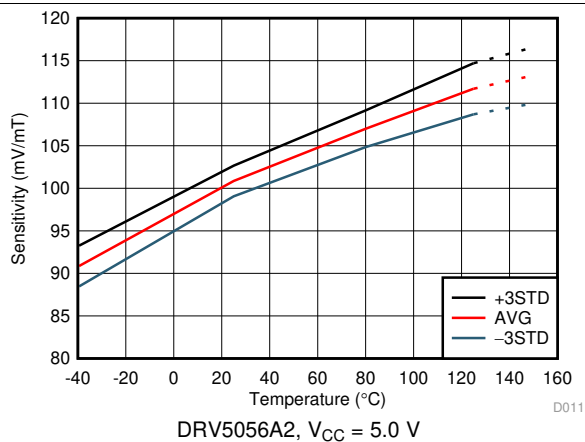

Figure 9. Sensitivity vs Temperature

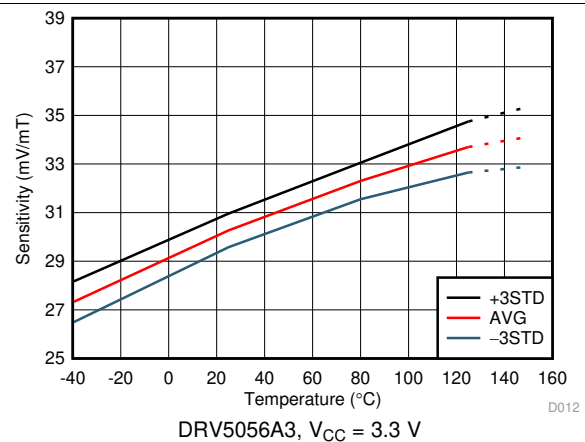

Figure 10. Sensitivity vs Temperature

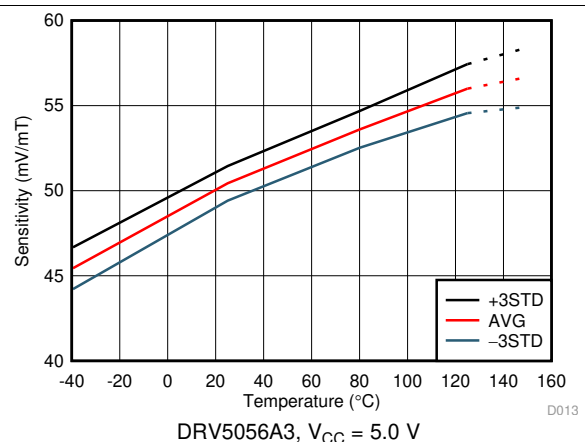

Figure 11. Sensitivity vs Temperature

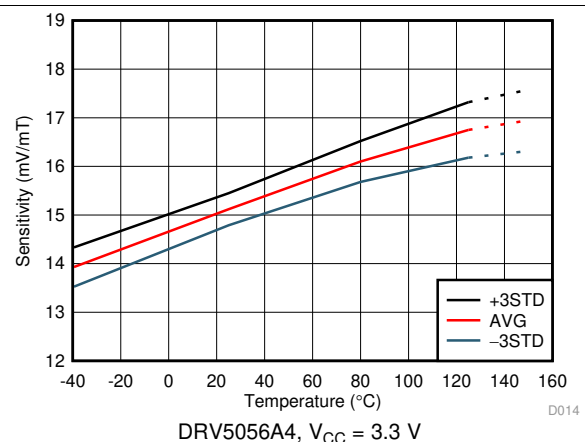
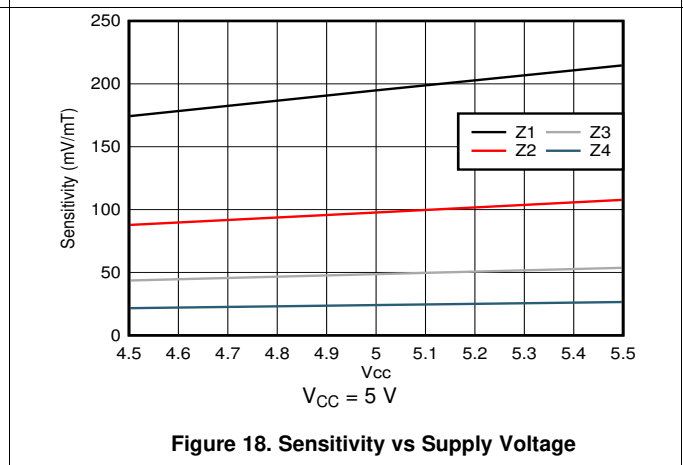
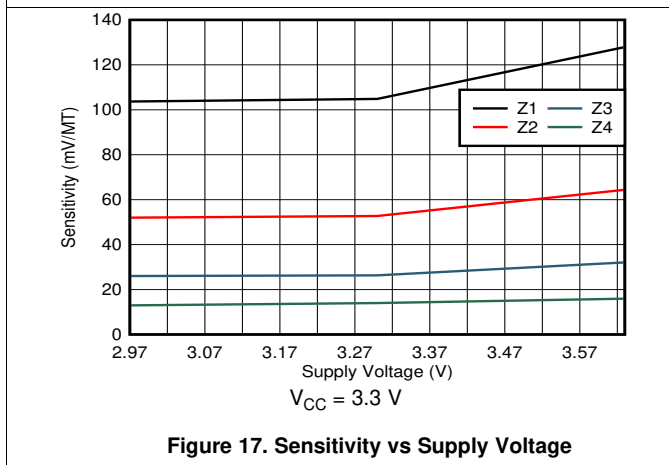
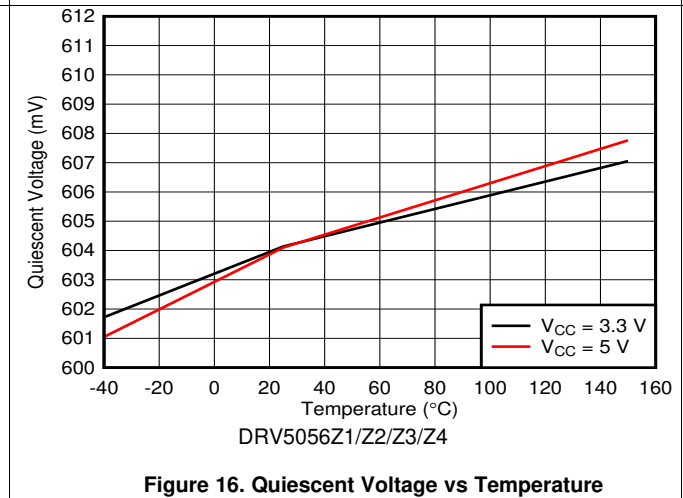
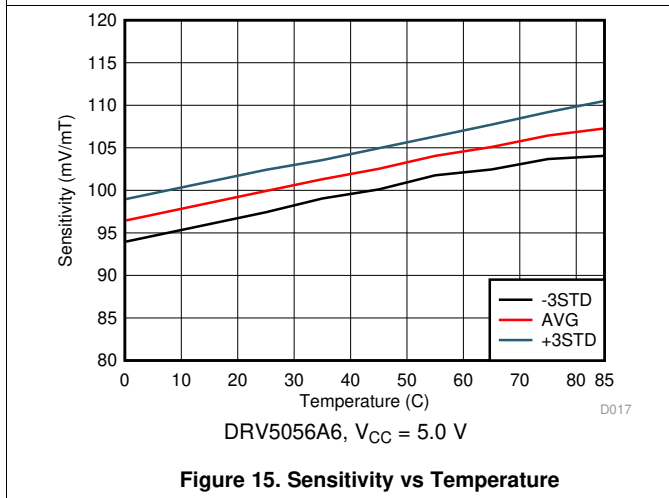
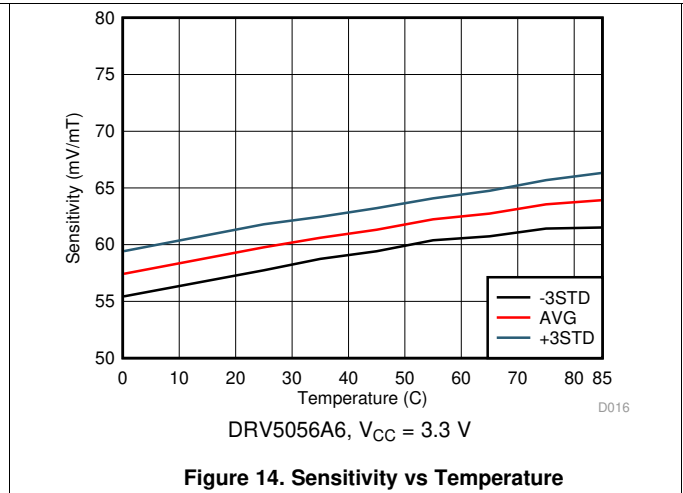
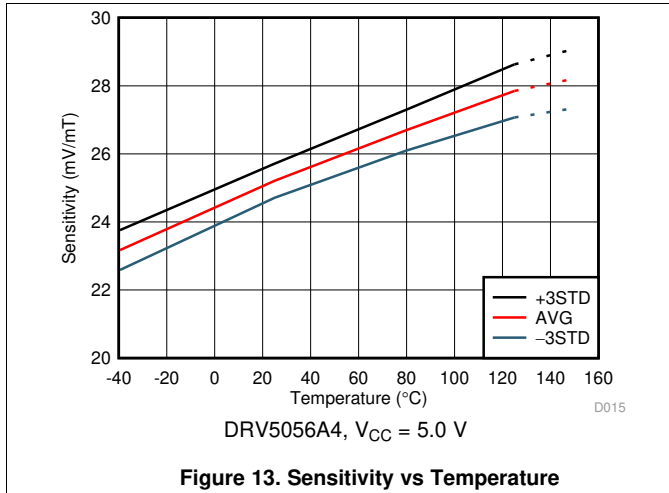

Figure 12. Sensitivity vs Temperature

Typical Characteristics (continued)

at  $T_A = 25^\circ\text{C}$  (unless otherwise noted)





Typical Characteristics (continued)

at  $T_A = 25^\circ\text{C}$  (unless otherwise noted)

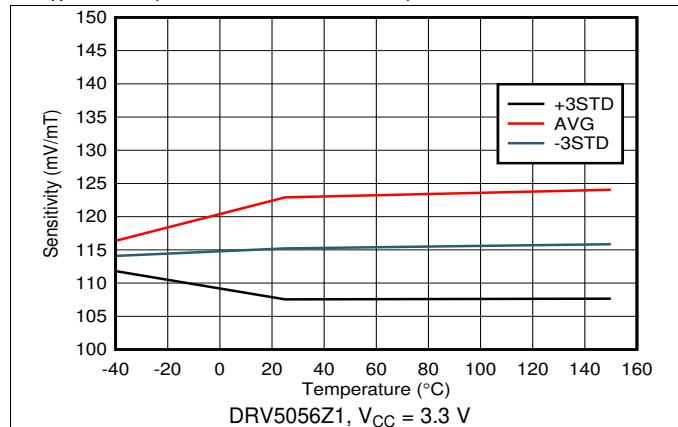

Figure 19. Sensitivity vs Temperature

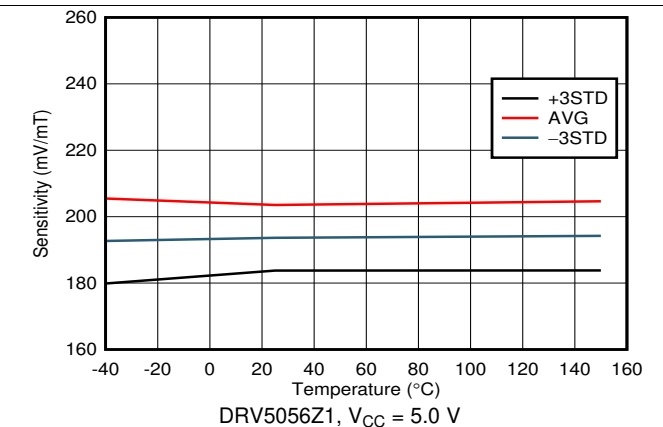

Figure 20. Sensitivity vs Temperature

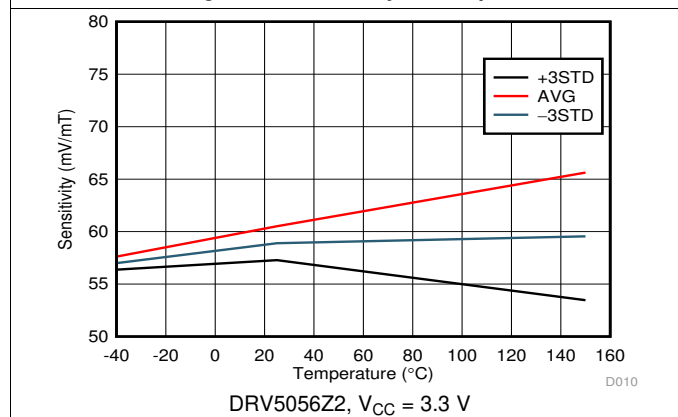

Figure 21. Sensitivity vs Temperature

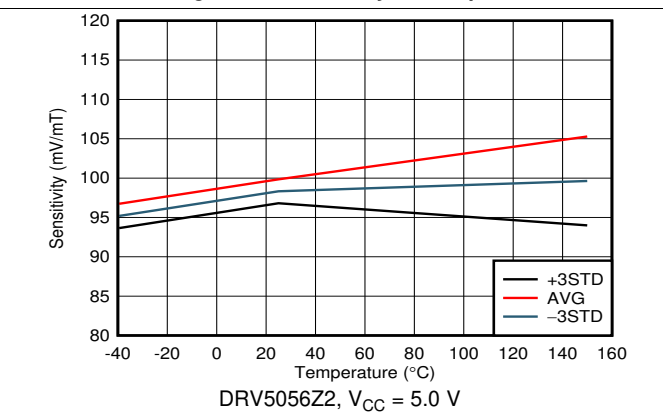

Figure 22. Sensitivity vs Temperature

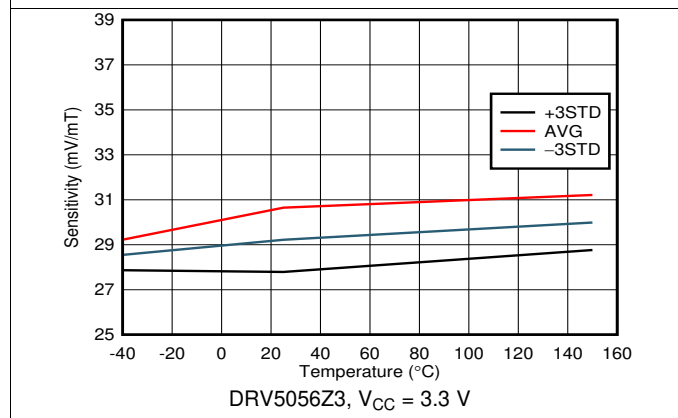

Figure 23. Sensitivity vs Temperature

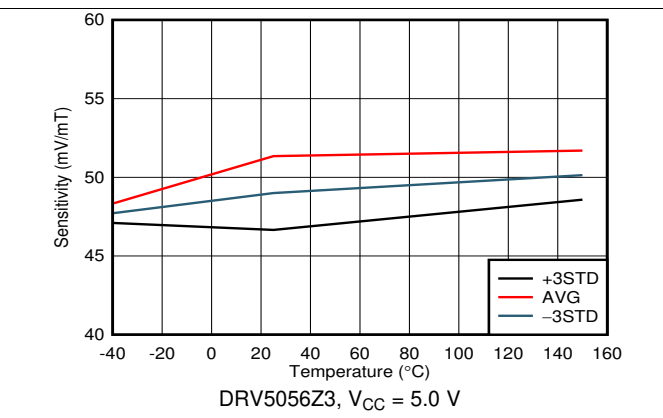
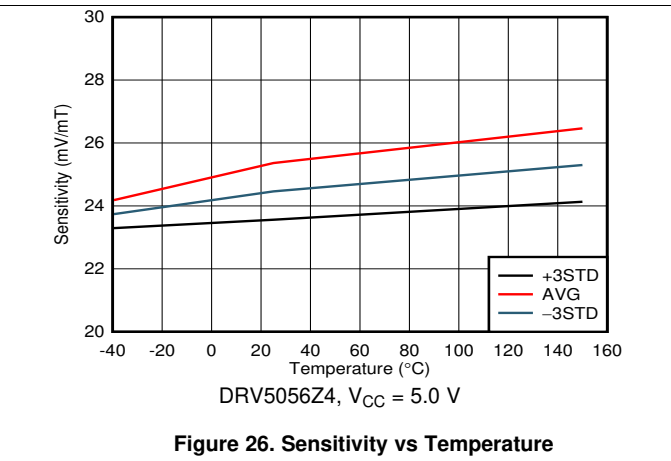
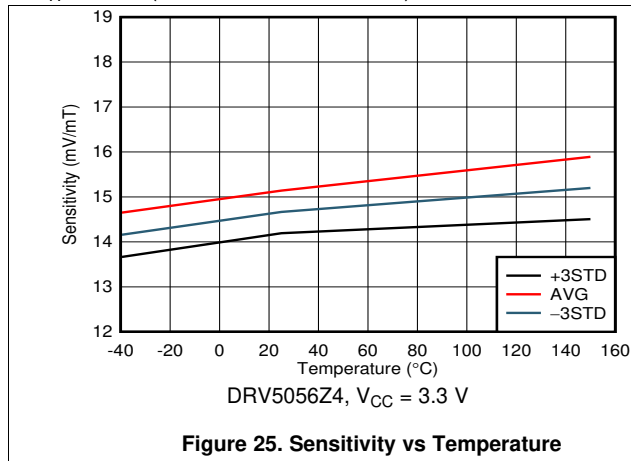

Figure 24. Sensitivity vs Temperature

## Typical Characteristics (continued)

at  $T_A = 25^\circ\text{C}$  (unless otherwise noted)



## 7 Detailed Description

### 7.1 Overview

The DRV5056 is a 3-pin linear Hall effect sensor with fully integrated signal conditioning, temperature compensation circuits, mechanical stress cancellation, and amplifiers. The device operates from 3.3-V and 5-V ( $\pm 10\%$ ) power supplies, measures magnetic flux density, and outputs a proportional analog voltage that is referenced to  $V_{CC}$ .

### 7.2 Functional Block Diagram

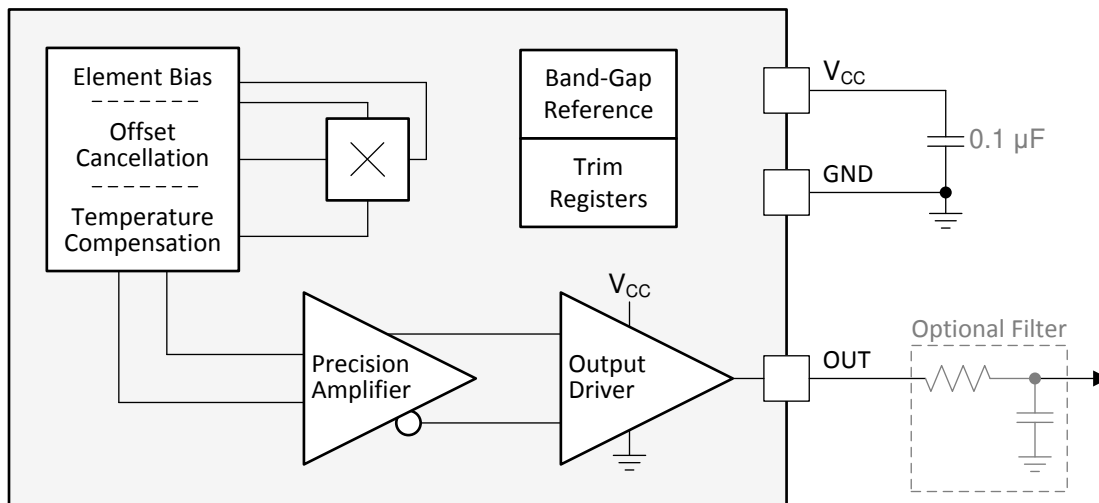

### 7.3 Feature Description

#### 7.3.1 Magnetic Flux Direction

As shown in Figure 27, the DRV5056 is sensitive to the magnetic field component that is perpendicular to the die inside the package.

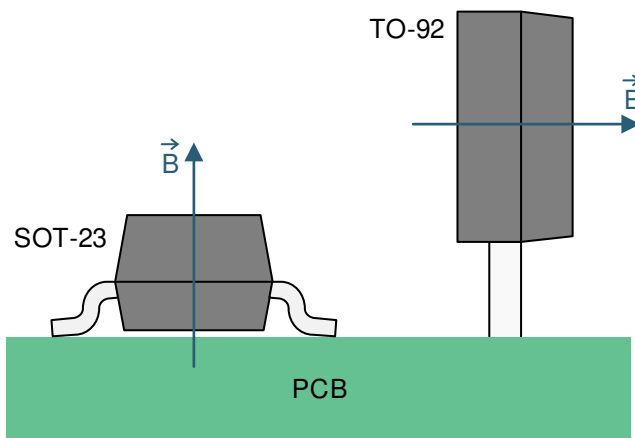
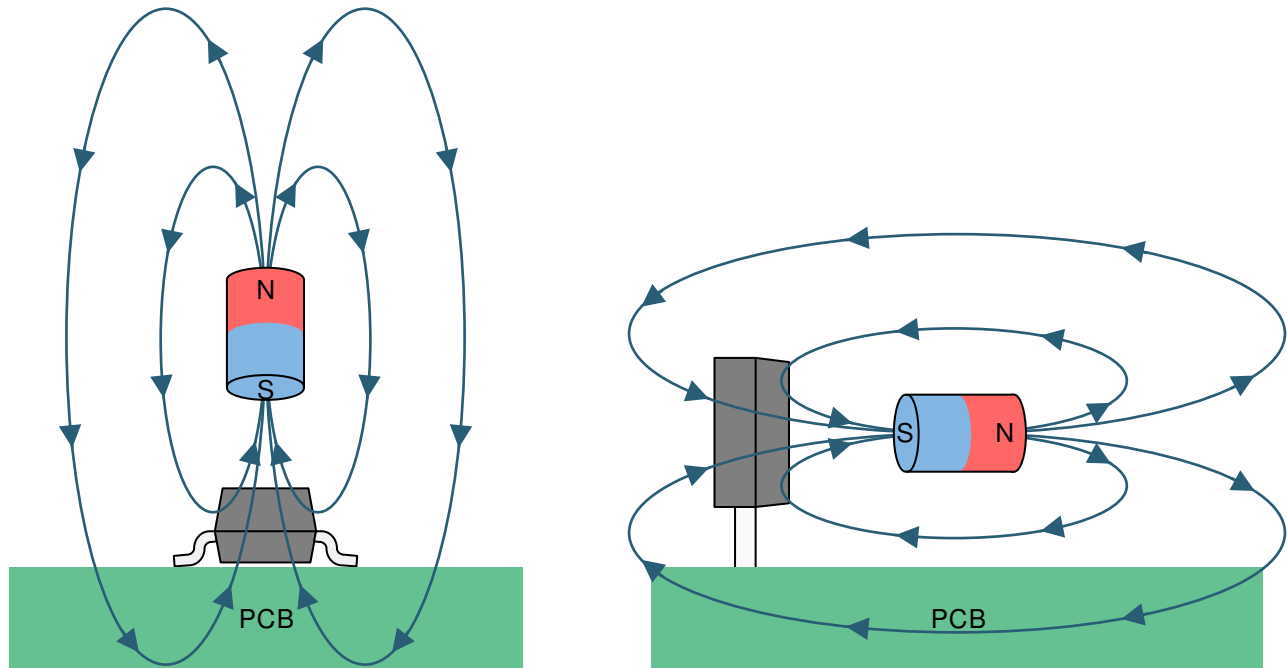

Figure 27. Direction of Sensitivity

## Feature Description (continued)

Magnetic flux that travels from the bottom to the top of the package is considered positive. This condition exists when a south magnetic pole is near the top (marked-side) of the package. Magnetic flux that travels from the top to the bottom of the package results in negative millitesla values.



**Figure 28. The Flux Direction for Positive B**

### 7.3.2 Magnetic Response

The DRV5056 outputs an analog voltage according to [Equation 1](#) when in the presence of a magnetic field:

$$V_{OUT} = V_Q + B \times (\text{Sensitivity}_{(25^\circ\text{C})} \times (1 + S_{TC} \times (T_A - 25^\circ\text{C})))$$

where

- $V_Q$  is typically 600 mV
- $B$  is the applied magnetic flux density
- $\text{Sensitivity}_{(25^\circ\text{C})}$  depends on the device option and  $V_{CC}$
- $S_{TC}$  is typically 0.12%/°C for device options DRV5056A1 - DRV5056A4 and is 0%/°C for DRV5056Z1 - DRV5056Z4 options
- $T_A$  is the ambient temperature
- $V_{OUT}$  is within the  $V_L$  range

(1)

As an example, consider the DRV5056A3 with  $V_{CC} = 3.3$  V, a temperature of 50°C, and 67 mT applied. Excluding tolerances,  $V_{OUT} = 600$  mV + 67 mT × (30 mV/mT × [1 + 0.0012/°C × (50°C – 25°C)]) = 2.67 V.

The DRV5056 only responds to the flux density of a magnetic south pole.

## Feature Description (continued)

### 7.3.3 Sensitivity Linearity

The device produces a linear response when the output voltage is within the specified  $V_L$  range. Outside this range, sensitivity is reduced and nonlinear. Figure 29 graphs the magnetic response.

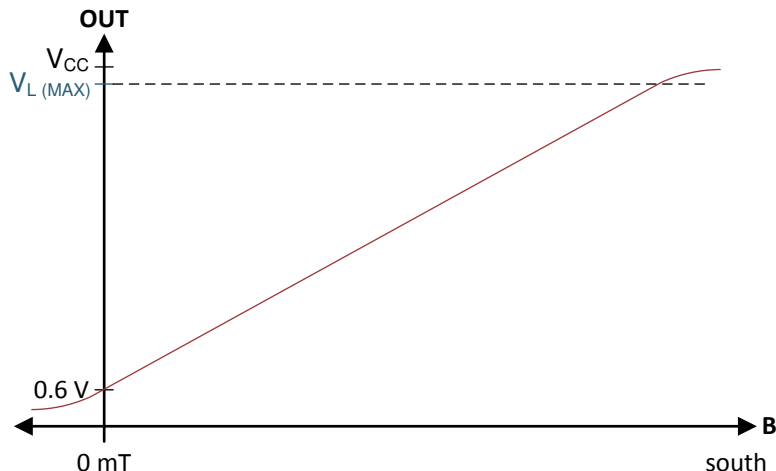

Figure 29. Magnetic Response

Equation 2 calculates parameter  $B_L$ , the minimum linear sensing range at 25°C taking into account the maximum quiescent voltage and sensitivity tolerances.

$$B_{L(MIN)} = \frac{V_{L(MAX)} - V_{Q(MAX)}}{S_{(MAX)}} \quad (2)$$

The parameter  $S_{LE}$  defines linearity error as the difference in sensitivity between any two positive  $B$  values when the output is within the  $V_L$  range.

### 7.3.4 Ratiometric Architecture

The DRV5056 has a ratiometric analog architecture that scales the sensitivity linearly with the power-supply voltage. For example, the sensitivity is 5% higher when  $V_{CC} = 5.25$  V compared to  $V_{CC} = 5$  V. This behavior enables external ADCs to digitize a more consistent value regardless of the power-supply voltage tolerance, when the ADC uses  $V_{CC}$  as its reference.

Equation 3 calculates sensitivity ratiometry error:

$$S_{RE} = 1 - \frac{S_{(V_{CC})} / S_{(5V)}}{V_{CC} / 5V} \quad \text{for } V_{CC} = 4.5 \text{ V to } 5.5 \text{ V}, \quad S_{RE} = 1 - \frac{S_{(V_{CC})} / S_{(3.3V)}}{V_{CC} / 3.3V} \quad \text{for } V_{CC} = 3 \text{ V to } 3.6 \text{ V}$$

where

- $S_{(V_{CC})}$  is the sensitivity at the current  $V_{CC}$  voltage
  - $S_{(5V)}$  or  $S_{(3.3V)}$  is the sensitivity when  $V_{CC} = 5$  V or 3.3 V
  - $V_{CC}$  is the current  $V_{CC}$  voltage
- (3)

## Feature Description (continued)

### 7.3.5 Operating $V_{CC}$ Ranges

The DRV5056 has two recommended operating  $V_{CC}$  ranges: 3 V to 3.6 V and 4.5 V to 5.5 V. When  $V_{CC}$  is in the middle region between 3.6 V to 4.5 V, the device continues to function, but sensitivity is less known because there is a crossover threshold near 4 V that adjusts device characteristics.

### 7.3.6 Sensitivity Temperature Compensation For Magnets

Magnets generally produce weaker fields as temperature increases. The DRV5056 can either compensate by increasing sensitivity with temperature or keep the sensitivity constant, as defined by the parameters  $S_{TC}$  and  $S_{TCZ}$  respectively. For device options DRV5055A1 - DRV5055A4, the sensitivity at  $T_A = 125^\circ\text{C}$  is typically 12% higher than at  $T_A = 25^\circ\text{C}$ . For device options DRV5055Z1 - DRV5055Z4, the sensitivity at  $T_A = 125^\circ\text{C}$  is typically same as the value at  $T_A = 25^\circ\text{C}$ .

### 7.3.7 Power-On Time

After the  $V_{CC}$  voltage is applied, the DRV5056 requires a short initialization time before the output is set. The parameter  $t_{ON}$  describes the time from when  $V_{CC}$  crosses 3 V until OUT is within 5% of  $V_Q$ , with 0 mT applied and no load attached to OUT. [Figure 30](#) shows this timing diagram.

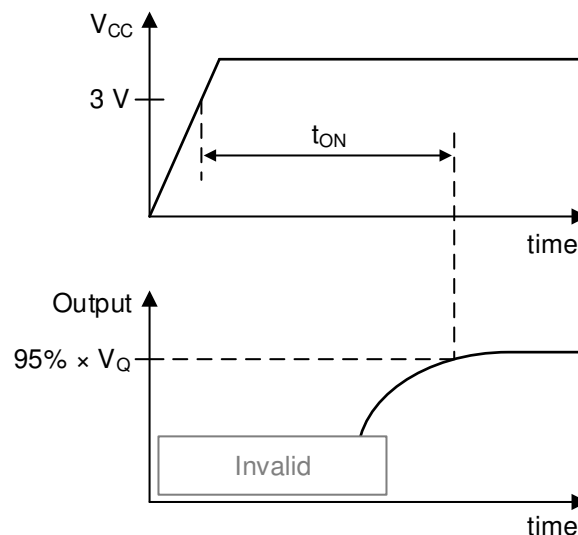

**Figure 30.  $t_{ON}$  Definition**

## Feature Description (continued)

### 7.3.8 Hall Element Location

Figure 31 shows the location of the sensing element inside each package option.

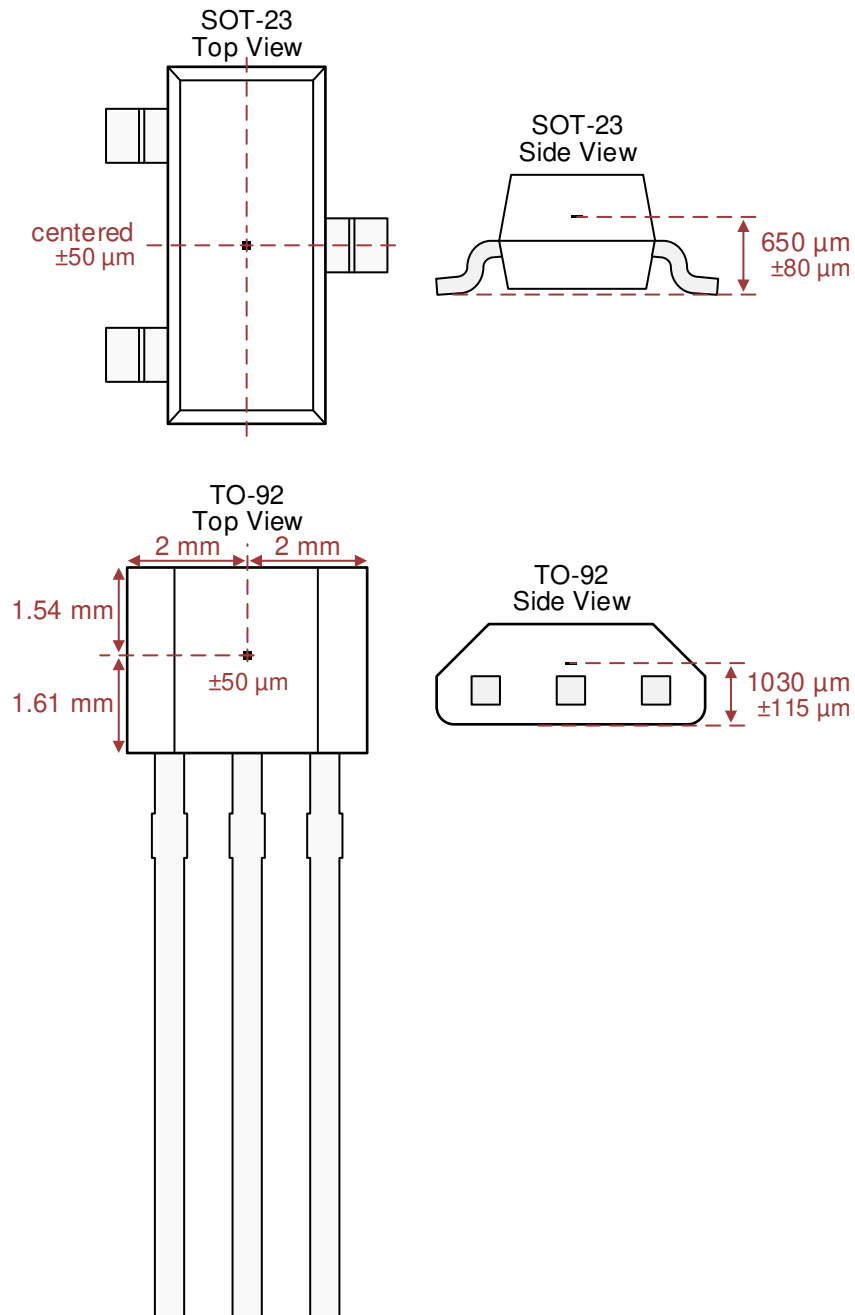

Figure 31. Hall Element Location

## 7.4 Device Functional Modes

The DRV5056 has one mode of operation that applies when the *Recommended Operating Conditions* are met.

## 8 Application and Implementation

### NOTE

Information in the following applications sections is not part of the TI component specification, and TI does not warrant its accuracy or completeness. TI's customers are responsible for determining suitability of components for their purposes. Customers should validate and test their design implementation to confirm system functionality.

### 8.1 Application Information

#### 8.1.1 Selecting the Sensitivity Option

Select the highest DRV5056 sensitivity option that can measure the required range of magnetic flux density, so that the output voltage swing is maximized.

Larger magnets and greater sensing distances can generally enable better positional accuracy than very small magnets at close distances, because magnetic flux density increases exponentially with the proximity to a magnet.

#### 8.1.2 Temperature Compensation for Magnets

The DRV5056 temperature compensation is designed to directly compensate the average drift of neodymium (NdFeB) magnets and partially compensate ferrite magnets. The residual flux density ( $B_r$ ) of a magnet typically reduces by 0.12%/°C for NdFeB, and 0.20%/°C for ferrite. When the operating temperature range of a system is reduced, temperature drift errors are also reduced.

#### 8.1.3 Adding a Low-Pass Filter

As illustrated in the *Functional Block Diagram*, an RC low-pass filter can be added to the device output for the purpose of minimizing voltage noise when the full 20-kHz bandwidth is not needed. This filter can improve the signal-to-noise ratio (SNR) and overall accuracy. Do not connect a capacitor directly to the device output without a resistor in between because doing so can make the output unstable.

#### 8.1.4 Designing for Wire Break Detection

Some systems must detect if interconnect wires become open or shorted. The DRV5056 can support this function.

First, select a sensitivity option that causes the output voltage to stay within the  $V_L$  range during normal operation. Second, add a pullup resistor between OUT and  $V_{CC}$ . TI recommends a value between 20 k $\Omega$  to 100 k $\Omega$ , and the current through OUT must not exceed the  $I_O$  specification, including current going into an external ADC. Then, if the output voltage is ever measured to be within 150 mV of  $V_{CC}$  or GND, a fault condition exists. [Figure 32](#) shows the circuit, and [Table 1](#) describes fault scenarios.

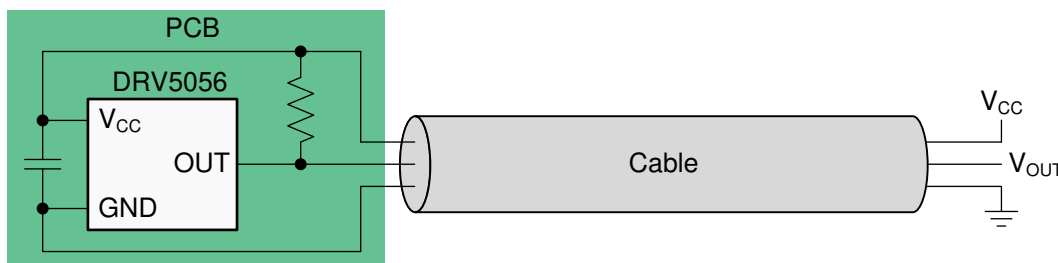

Figure 32. Wire Fault Detection Circuit



**Table 1. Fault Scenarios and the Resulting  $V_{OUT}$**

| FAULT SCENARIO         | $V_{OUT}$         |
|------------------------|-------------------|
| $V_{CC}$ disconnects   | Close to GND      |
| GND disconnects        | Close to $V_{CC}$ |
| $V_{CC}$ shorts to OUT | Close to $V_{CC}$ |
| GND shorts to OUT      | Close to GND      |

## 8.2 Typical Application

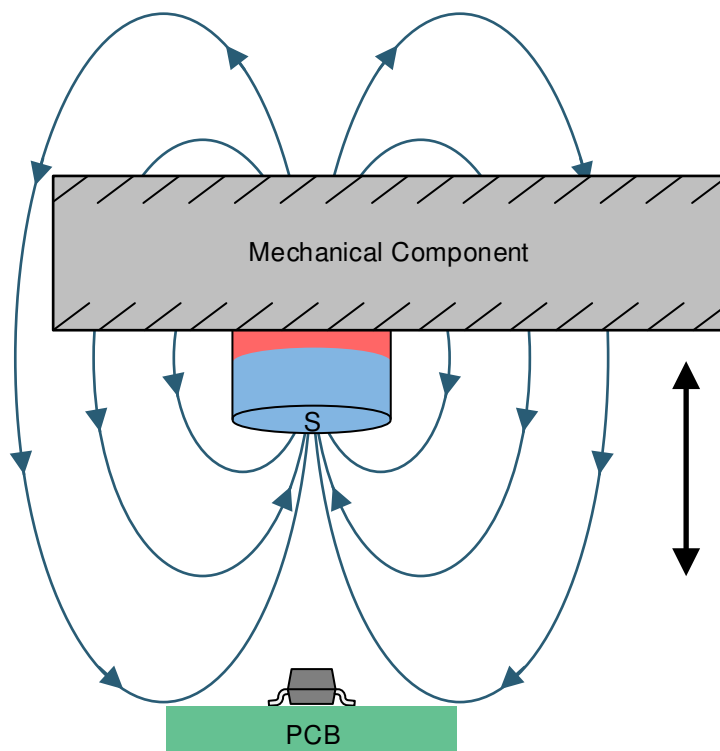

**Figure 33. Unipolar Sensing Application**

### 8.2.1 Design Requirements

Use the parameters listed in [Table 2](#) for this design example.

**Table 2. Design Parameters**

| DESIGN PARAMETER                | EXAMPLE VALUE                                |
|---------------------------------|--|
| $V_{CC}$                        | 3.3 V  |
| Magnet                          | 10-mm diameter × 6-mm long cylinder, ferrite |
| Distance from magnet to sensor  | From 20 mm to 3 mm                           |
| Maximum B at the sensor at 25°C | 72 mT at 3 mm                                |
| Device option                   | DRV5056A3                                    |

### 8.2.2 Detailed Design Procedure

This design example consists of a mechanical component that moves back and forth, an embedded magnet with the south pole facing the printed-circuit board, and a DRV5056. The DRV5056 outputs an analog voltage that describes the precise position of the component. The component must not contain ferromagnetic materials such as iron, nickel, and cobalt because these materials change the magnetic flux density at the sensor.

When designing a linear magnetic sensing system, always consider these three variables: the magnet, sensing distance, and range of the sensor. Select the DRV5056 with the highest sensitivity that has a  $B_L$  (linear magnetic sensing range) that is larger than the maximum magnetic flux density in the application.

Magnets are made from various ferromagnetic materials that have tradeoffs in cost, drift with temperature, absolute maximum temperature ratings, remanence or residual induction ( $B_r$ ), and coercivity ( $H_c$ ). The  $B_r$  and the dimensions of a magnet determine the magnetic flux density ( $B$ ) produced in 3-dimensional space. For simple magnet shapes, such as rectangular blocks and cylinders, there are simple equations that solve  $B$  at a given distance centered with the magnet. Figure 34 shows diagrams for Equation 4 and Equation 5.

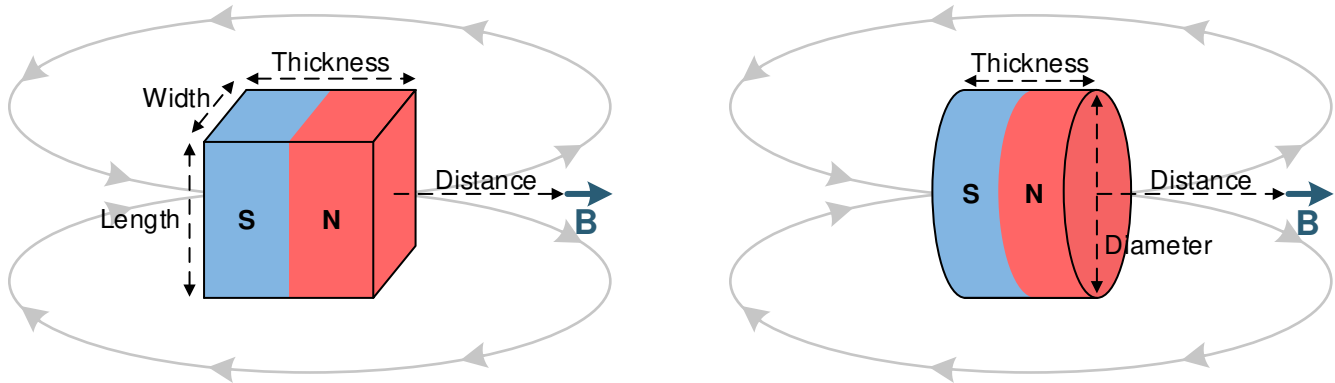

Figure 34. Rectangular Block and Cylinder Magnets

Use Equation 4 for the rectangular block shown in Figure 34:

$$\vec{B} = \frac{B_r}{\pi} \left( \arctan\left(\frac{WL}{2D\sqrt{4D^2 + W^2 + L^2}}\right) - \arctan\left(\frac{WL}{2(D+T)\sqrt{4(D+T)^2 + W^2 + L^2}}\right) \right) \tag{4}$$

Use Equation 5 for the cylinder shown in Figure 34:

$$\vec{B} = \frac{B_r}{2} \left( \frac{D+T}{\sqrt{(0.5C)^2 + (D+T)^2}} - \frac{D}{\sqrt{(0.5C)^2 + D^2}} \right)$$

where

- W is width
- L is length
- T is thickness (the direction of magnetization)
- D is distance
- C is diameter

(5)

### 8.2.3 Application Curve

Figure 35 shows the magnetic flux density versus distance for a 10-mm × 6-mm cylinder ferrite magnet.

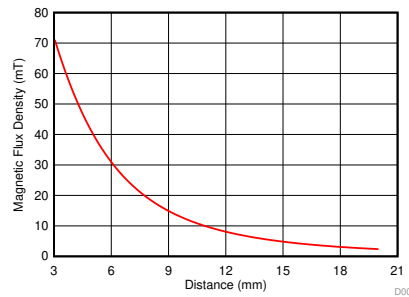

**Figure 35. Magnetic Profile of a 10-mm × 6-mm Cylindrical Ferrite Magnet**

### 8.3 What to Do and What Not to Do

Because the Hall element is sensitive to magnetic fields that are perpendicular to the top of the package, a correct magnet approach must be used for the sensor to detect the field. Figure 36 illustrates correct and incorrect approaches.

What to Do and What Not to Do (continued)

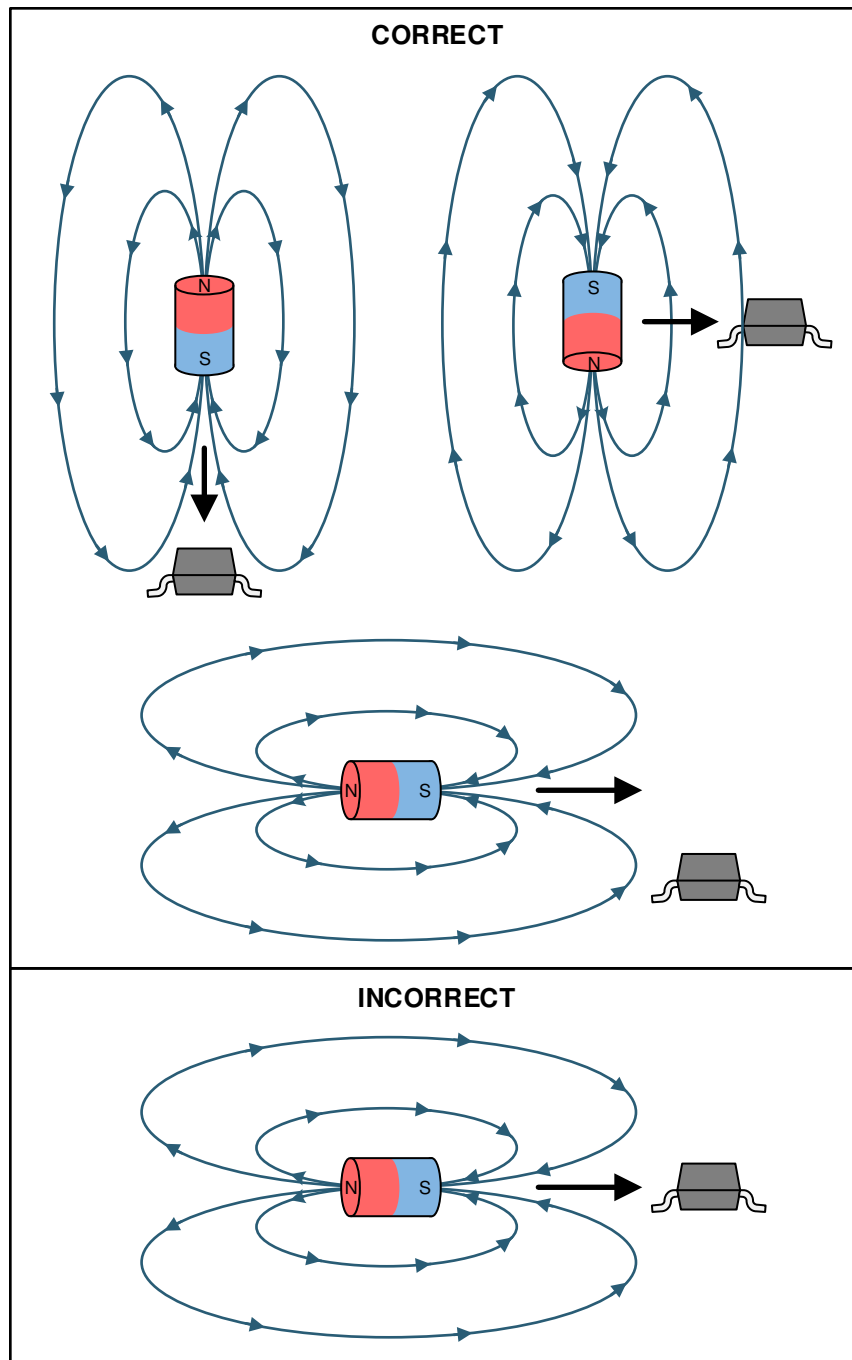

Figure 36. Correct and Incorrect Magnet Approaches

## 9 Power Supply Recommendations

A decoupling capacitor close to the device must be used to provide local energy with minimal inductance. TI recommends using a ceramic capacitor with a value of at least 0.01  $\mu\text{F}$ .

## 10 Layout

### 10.1 Layout Guidelines

Magnetic fields pass through most nonferromagnetic materials with no significant disturbance. Embedding Hall effect sensors within plastic or aluminum enclosures and sensing magnets on the outside is common practice. Magnetic fields also easily pass through most printed-circuit boards, which makes placing the magnet on the opposite side possible.

### 10.2 Layout Examples

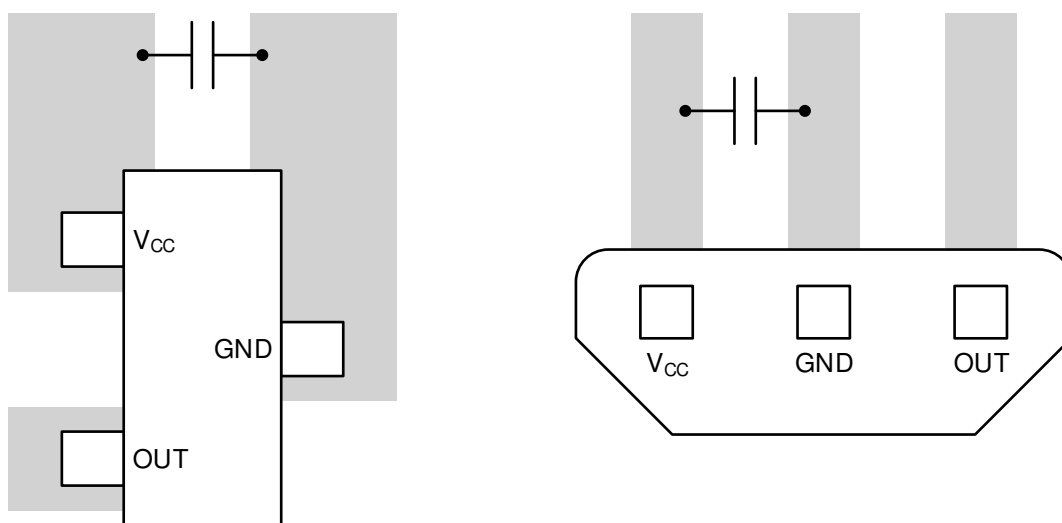

Figure 37. Layout Examples

## 11 Device and Documentation Support

### 11.1 Documentation Support

#### 11.1.1 Related Documentation

For related documentation see the following:

- Texas Instruments, [Incremental rotary encoder design considerations application note](#)
- Texas Instruments, [Using linear hall effect sensors to measure angle application note](#)
- Texas Instruments, [Angle measurements with linear hall effect sensors](#)

#### 11.2 Receiving Notification of Documentation Updates

To receive notification of documentation updates, navigate to the device product folder on ti.com. In the upper right corner, click on *Alert me* to register and receive a weekly digest of any product information that has changed. For change details, review the revision history included in any revised document.

#### 11.3 Community Resources

TI E2E™ support forums are an engineer's go-to source for fast, verified answers and design help — straight from the experts. Search existing answers or ask your own question to get the quick design help you need.

Linked content is provided "AS IS" by the respective contributors. They do not constitute TI specifications and do not necessarily reflect TI's views; see TI's [Terms of Use](#).

#### 11.4 Trademarks

E2E is a trademark of Texas Instruments.  
All other trademarks are the property of their respective owners.

#### 11.5 Electrostatic Discharge Caution



This integrated circuit can be damaged by ESD. Texas Instruments recommends that all integrated circuits be handled with appropriate precautions. Failure to observe proper handling and installation procedures can cause damage.

ESD damage can range from subtle performance degradation to complete device failure. Precision integrated circuits may be more susceptible to damage because very small parametric changes could cause the device not to meet its published specifications.

#### 11.6 Glossary

[SLYZ022](#) — *TI Glossary*.

This glossary lists and explains terms, acronyms, and definitions.

## 12 Mechanical, Packaging, and Orderable Information

The following pages include mechanical, packaging, and orderable information. This information is the most current data available for the designated devices. This data is subject to change without notice and revision of this document. For browser-based versions of this data sheet, refer to the left-hand navigation.

**PACKAGING INFORMATION**

| Orderable Device | Status<br>(1) | Package Type | Package Drawing | Pins | Package Qty | Eco Plan<br>(2) | Lead finish/<br>Ball material<br>(6) | MSL Peak Temp<br>(3) | Op Temp (°C) | Device Marking<br>(4/5) | Samples                 |
|------------------|---------------|--------------|-----------------|------|-------------|-----------------|--------------------------------------|----------------------|--------------|-------------------------|-------------------------|
| DRV5056A1QDBZR   | ACTIVE        | SOT-23       | DBZ             | 3    | 3000        | RoHS & Green    | SN                                   | Level-2-260C-1 YEAR  | -40 to 125   | 56A1                    | <a href="#">Samples</a> |
| DRV5056A1QDBZT   | ACTIVE        | SOT-23       | DBZ             | 3    | 250         | RoHS & Green    | SN                                   | Level-2-260C-1 YEAR  | -40 to 125   | 56A1                    | <a href="#">Samples</a> |
| DRV5056A1QLPG    | ACTIVE        | TO-92        | LPG             | 3    | 1000        | RoHS & Green    | SN                                   | N / A for Pkg Type   | -40 to 125   | 56A1                    | <a href="#">Samples</a> |
| DRV5056A1QLPGM   | ACTIVE        | TO-92        | LPG             | 3    | 3000        | RoHS & Green    | SN                                   | N / A for Pkg Type   | -40 to 125   | 56A1                    | <a href="#">Samples</a> |
| DRV5056A2QDBZR   | ACTIVE        | SOT-23       | DBZ             | 3    | 3000        | RoHS & Green    | SN                                   | Level-2-260C-1 YEAR  | -40 to 125   | 56A2                    | <a href="#">Samples</a> |
| DRV5056A2QDBZT   | ACTIVE        | SOT-23       | DBZ             | 3    | 250         | RoHS & Green    | SN                                   | Level-2-260C-1 YEAR  | -40 to 125   | 56A2                    | <a href="#">Samples</a> |
| DRV5056A2QLPG    | ACTIVE        | TO-92        | LPG             | 3    | 1000        | RoHS & Green    | SN                                   | N / A for Pkg Type   | -40 to 125   | 56A2                    | <a href="#">Samples</a> |
| DRV5056A2QLPGM   | ACTIVE        | TO-92        | LPG             | 3    | 3000        | RoHS & Green    | SN                                   | N / A for Pkg Type   | -40 to 125   | 56A2                    | <a href="#">Samples</a> |
| DRV5056A3QDBZR   | ACTIVE        | SOT-23       | DBZ             | 3    | 3000        | RoHS & Green    | SN                                   | Level-2-260C-1 YEAR  | -40 to 125   | 56A3                    | <a href="#">Samples</a> |
| DRV5056A3QDBZT   | ACTIVE        | SOT-23       | DBZ             | 3    | 250         | RoHS & Green    | SN                                   | Level-2-260C-1 YEAR  | -40 to 125   | 56A3                    | <a href="#">Samples</a> |
| DRV5056A3QLPG    | ACTIVE        | TO-92        | LPG             | 3    | 1000        | RoHS & Green    | SN                                   | N / A for Pkg Type   | -40 to 125   | 56A3                    | <a href="#">Samples</a> |
| DRV5056A3QLPGM   | ACTIVE        | TO-92        | LPG             | 3    | 3000        | RoHS & Green    | SN                                   | N / A for Pkg Type   | -40 to 125   | 56A3                    | <a href="#">Samples</a> |
| DRV5056A4QDBZR   | ACTIVE        | SOT-23       | DBZ             | 3    | 3000        | RoHS & Green    | SN                                   | Level-2-260C-1 YEAR  | -40 to 125   | 56A4                    | <a href="#">Samples</a> |
| DRV5056A4QDBZT   | ACTIVE        | SOT-23       | DBZ             | 3    | 250         | RoHS & Green    | SN                                   | Level-2-260C-1 YEAR  | -40 to 125   | 56A4                    | <a href="#">Samples</a> |
| DRV5056A4QLPG    | ACTIVE        | TO-92        | LPG             | 3    | 1000        | RoHS & Green    | SN                                   | N / A for Pkg Type   | -40 to 125   | 56A4                    | <a href="#">Samples</a> |
| DRV5056A4QLPGM   | ACTIVE        | TO-92        | LPG             | 3    | 3000        | RoHS & Green    | SN                                   | N / A for Pkg Type   | -40 to 125   | 56A4                    | <a href="#">Samples</a> |
| DRV5056A6QDBZR   | ACTIVE        | SOT-23       | DBZ             | 3    | 3000        | RoHS & Green    | SN                                   | Level-2-260C-1 YEAR  | -40 to 125   | 56A6                    | <a href="#">Samples</a> |
| DRV5056A6QDBZT   | ACTIVE        | SOT-23       | DBZ             | 3    | 250         | RoHS & Green    | SN                                   | Level-2-260C-1 YEAR  | -40 to 125   | 56A6                    | <a href="#">Samples</a> |
| DRV5056Z1QDBZR   | ACTIVE        | SOT-23       | DBZ             | 3    | 3000        | RoHS & Green    | SN                                   | Level-2-260C-1 YEAR  | -40 to 125   | 56Z1                    | <a href="#">Samples</a> |
| DRV5056Z1QDBZT   | ACTIVE        | SOT-23       | DBZ             | 3    | 250         | RoHS & Green    | SN                                   | Level-2-260C-1 YEAR  | -40 to 125   | 56Z1                    | <a href="#">Samples</a> |

| Orderable Device | Status<br>(1) | Package Type | Package Drawing | Pins | Package Qty | Eco Plan<br>(2) | Lead finish/<br>Ball material<br>(6) | MSL Peak Temp<br>(3) | Op Temp (°C) | Device Marking<br>(4/5) | Samples                 |
|------------------|---------------|--------------|-----------------|------|-------------|-----------------|--------------------------------------|----------------------|--------------|-------------------------|-------------------------|
| DRV5056Z2QDBZR   | ACTIVE        | SOT-23       | DBZ             | 3    | 3000        | RoHS & Green    | SN                                   | Level-2-260C-1 YEAR  | -40 to 125   | 56Z2                    | <a href="#">Samples</a> |
| DRV5056Z2QDBZT   | ACTIVE        | SOT-23       | DBZ             | 3    | 250         | RoHS & Green    | SN                                   | Level-2-260C-1 YEAR  | -40 to 125   | 56Z2                    | <a href="#">Samples</a> |
| DRV5056Z3QDBZR   | ACTIVE        | SOT-23       | DBZ             | 3    | 3000        | RoHS & Green    | SN                                   | Level-2-260C-1 YEAR  | -40 to 125   | 56Z3                    | <a href="#">Samples</a> |
| DRV5056Z3QDBZT   | ACTIVE        | SOT-23       | DBZ             | 3    | 250         | RoHS & Green    | SN                                   | Level-2-260C-1 YEAR  | -40 to 125   | 56Z3                    | <a href="#">Samples</a> |
| DRV5056Z4QDBZR   | ACTIVE        | SOT-23       | DBZ             | 3    | 3000        | RoHS & Green    | SN                                   | Level-2-260C-1 YEAR  | -40 to 125   | 56Z4                    | <a href="#">Samples</a> |
| DRV5056Z4QDBZT   | ACTIVE        | SOT-23       | DBZ             | 3    | 250         | RoHS & Green    | SN                                   | Level-2-260C-1 YEAR  | -40 to 125   | 56Z4                    | <a href="#">Samples</a> |

(1) The marketing status values are defined as follows:

**ACTIVE:** Product device recommended for new designs.

**LIFEBUY:** TI has announced that the device will be discontinued, and a lifetime-buy period is in effect.

**NRND:** Not recommended for new designs. Device is in production to support existing customers, but TI does not recommend using this part in a new design.

**PREVIEW:** Device has been announced but is not in production. Samples may or may not be available.

**OBSOLETE:** TI has discontinued the production of the device.

(2) **RoHS:** TI defines "RoHS" to mean semiconductor products that are compliant with the current EU RoHS requirements for all 10 RoHS substances, including the requirement that RoHS substance do not exceed 0.1% by weight in homogeneous materials. Where designed to be soldered at high temperatures, "RoHS" products are suitable for use in specified lead-free processes. TI may reference these types of products as "Pb-Free".

**RoHS Exempt:** TI defines "RoHS Exempt" to mean products that contain lead but are compliant with EU RoHS pursuant to a specific EU RoHS exemption.

**Green:** TI defines "Green" to mean the content of Chlorine (Cl) and Bromine (Br) based flame retardants meet JS709B low halogen requirements of <=1000ppm threshold. Antimony trioxide based flame retardants must also meet the <=1000ppm threshold requirement.

(3) MSL, Peak Temp. - The Moisture Sensitivity Level rating according to the JEDEC industry standard classifications, and peak solder temperature.

(4) There may be additional marking, which relates to the logo, the lot trace code information, or the environmental category on the device.

(5) Multiple Device Markings will be inside parentheses. Only one Device Marking contained in parentheses and separated by a "~" will appear on a device. If a line is indented then it is a continuation of the previous line and the two combined represent the entire Device Marking for that device.

(6) Lead finish/Ball material - Orderable Devices may have multiple material finish options. Finish options are separated by a vertical ruled line. Lead finish/Ball material values may wrap to two lines if the finish value exceeds the maximum column width.



**Important Information and Disclaimer:** The information provided on this page represents TI's knowledge and belief as of the date that it is provided. TI bases its knowledge and belief on information provided by third parties, and makes no representation or warranty as to the accuracy of such information. Efforts are underway to better integrate information from third parties. TI has taken and continues to take reasonable steps to provide representative and accurate information but may not have conducted destructive testing or chemical analysis on incoming materials and chemicals. TI and TI suppliers consider certain information to be proprietary, and thus CAS numbers and other limited information may not be available for release.

In no event shall TI's liability arising out of such information exceed the total purchase price of the TI part(s) at issue in this document sold by TI to Customer on an annual basis.

**OTHER QUALIFIED VERSIONS OF DRV5056 :**

- Automotive: [DRV5056-Q1](#)

NOTE: Qualified Version Definitions:

- Automotive - Q100 devices qualified for high-reliability automotive applications targeting zero defects

**TAPE AND REEL INFORMATION**

**QUADRANT ASSIGNMENTS FOR PIN 1 ORIENTATION IN TAPE**

\*All dimensions are nominal

| Device         | Package Type | Package Drawing | Pins | SPQ  | Reel Diameter (mm) | Reel Width W1 (mm) | A0 (mm) | B0 (mm) | K0 (mm) | P1 (mm) | W (mm) | Pin1 Quadrant |
|----------------|--------------|-----------------|------|------|--------------------|--------------------|---------|---------|---------|---------|--------|---------------|
| DRV5056A1QDBZR | SOT-23       | DBZ             | 3    | 3000 | 180.0              | 8.4                | 3.15    | 2.77    | 1.22    | 4.0     | 8.0    | Q3            |
| DRV5056A1QDBZT | SOT-23       | DBZ             | 3    | 250  | 180.0              | 8.4                | 3.15    | 2.77    | 1.22    | 4.0     | 8.0    | Q3            |
| DRV5056A2QDBZR | SOT-23       | DBZ             | 3    | 3000 | 180.0              | 8.4                | 3.15    | 2.77    | 1.22    | 4.0     | 8.0    | Q3            |
| DRV5056A2QDBZT | SOT-23       | DBZ             | 3    | 250  | 180.0              | 8.4                | 3.15    | 2.77    | 1.22    | 4.0     | 8.0    | Q3            |
| DRV5056A3QDBZR | SOT-23       | DBZ             | 3    | 3000 | 180.0              | 8.4                | 3.15    | 2.77    | 1.22    | 4.0     | 8.0    | Q3            |
| DRV5056A3QDBZT | SOT-23       | DBZ             | 3    | 250  | 180.0              | 8.4                | 3.15    | 2.77    | 1.22    | 4.0     | 8.0    | Q3            |
| DRV5056A4QDBZR | SOT-23       | DBZ             | 3    | 3000 | 180.0              | 8.4                | 3.15    | 2.77    | 1.22    | 4.0     | 8.0    | Q3            |
| DRV5056A4QDBZT | SOT-23       | DBZ             | 3    | 250  | 180.0              | 8.4                | 3.15    | 2.77    | 1.22    | 4.0     | 8.0    | Q3            |
| DRV5056A6QDBZR | SOT-23       | DBZ             | 3    | 3000 | 178.0              | 9.0                | 3.15    | 2.77    | 1.22    | 4.0     | 8.0    | Q3            |
| DRV5056A6QDBZT | SOT-23       | DBZ             | 3    | 3000 | 180.0              | 8.4                | 3.15    | 2.77    | 1.22    | 4.0     | 8.0    | Q3            |
| DRV5056A6QDBZT | SOT-23       | DBZ             | 3    | 250  | 180.0              | 8.4                | 3.15    | 2.77    | 1.22    | 4.0     | 8.0    | Q3            |
| DRV5056Z1QDBZR | SOT-23       | DBZ             | 3    | 3000 | 180.0              | 8.4                | 3.15    | 2.77    | 1.22    | 4.0     | 8.0    | Q3            |
| DRV5056Z1QDBZT | SOT-23       | DBZ             | 3    | 250  | 180.0              | 8.4                | 3.15    | 2.77    | 1.22    | 4.0     | 8.0    | Q3            |
| DRV5056Z2QDBZR | SOT-23       | DBZ             | 3    | 3000 | 180.0              | 8.4                | 3.15    | 2.77    | 1.22    | 4.0     | 8.0    | Q3            |
| DRV5056Z2QDBZT | SOT-23       | DBZ             | 3    | 250  | 180.0              | 8.4                | 3.15    | 2.77    | 1.22    | 4.0     | 8.0    | Q3            |
| DRV5056Z3QDBZR | SOT-23       | DBZ             | 3    | 3000 | 180.0              | 8.4                | 3.15    | 2.77    | 1.22    | 4.0     | 8.0    | Q3            |

| Device         | Package Type | Package Drawing | Pins | SPQ  | Reel Diameter (mm) | Reel Width W1 (mm) | A0 (mm) | B0 (mm) | K0 (mm) | P1 (mm) | W (mm) | Pin1 Quadrant |
|----------------|--------------|-----------------|------|------|--------------------|--------------------|---------|---------|---------|---------|--------|---------------|
| DRV5056Z3QDBZT | SOT-23       | DBZ             | 3    | 250  | 180.0              | 8.4                | 3.15    | 2.77    | 1.22    | 4.0     | 8.0    | Q3            |
| DRV5056Z4QDBZR | SOT-23       | DBZ             | 3    | 3000 | 180.0              | 8.4                | 3.15    | 2.77    | 1.22    | 4.0     | 8.0    | Q3            |
| DRV5056Z4QDBZT | SOT-23       | DBZ             | 3    | 250  | 180.0              | 8.4                | 3.15    | 2.77    | 1.22    | 4.0     | 8.0    | Q3            |

**TAPE AND REEL BOX DIMENSIONS**

\*All dimensions are nominal

| Device         | Package Type | Package Drawing | Pins | SPQ  | Length (mm) | Width (mm) | Height (mm) |
|----------------|--------------|-----------------|------|------|-------------|------------|-------------|
| DRV5056A1QDBZR | SOT-23       | DBZ             | 3    | 3000 | 213.0       | 191.0      | 35.0        |
| DRV5056A1QDBZT | SOT-23       | DBZ             | 3    | 250  | 213.0       | 191.0      | 35.0        |
| DRV5056A2QDBZR | SOT-23       | DBZ             | 3    | 3000 | 213.0       | 191.0      | 35.0        |
| DRV5056A2QDBZT | SOT-23       | DBZ             | 3    | 250  | 213.0       | 191.0      | 35.0        |
| DRV5056A3QDBZR | SOT-23       | DBZ             | 3    | 3000 | 213.0       | 191.0      | 35.0        |
| DRV5056A3QDBZT | SOT-23       | DBZ             | 3    | 250  | 213.0       | 191.0      | 35.0        |
| DRV5056A4QDBZR | SOT-23       | DBZ             | 3    | 3000 | 213.0       | 191.0      | 35.0        |
| DRV5056A4QDBZT | SOT-23       | DBZ             | 3    | 250  | 213.0       | 191.0      | 35.0        |
| DRV5056A6QDBZR | SOT-23       | DBZ             | 3    | 3000 | 180.0       | 180.0      | 18.0        |
| DRV5056A6QDBZT | SOT-23       | DBZ             | 3    | 3000 | 213.0       | 191.0      | 35.0        |
| DRV5056A6QDBZT | SOT-23       | DBZ             | 3    | 250  | 213.0       | 191.0      | 35.0        |
| DRV5056Z1QDBZR | SOT-23       | DBZ             | 3    | 3000 | 213.0       | 191.0      | 35.0        |
| DRV5056Z1QDBZT | SOT-23       | DBZ             | 3    | 250  | 213.0       | 191.0      | 35.0        |
| DRV5056Z2QDBZR | SOT-23       | DBZ             | 3    | 3000 | 213.0       | 191.0      | 35.0        |
| DRV5056Z2QDBZT | SOT-23       | DBZ             | 3    | 250  | 213.0       | 191.0      | 35.0        |
| DRV5056Z3QDBZR | SOT-23       | DBZ             | 3    | 3000 | 213.0       | 191.0      | 35.0        |
| DRV5056Z3QDBZT | SOT-23       | DBZ             | 3    | 250  | 213.0       | 191.0      | 35.0        |
| DRV5056Z4QDBZR | SOT-23       | DBZ             | 3    | 3000 | 213.0       | 191.0      | 35.0        |

---

| Device         | Package Type | Package Drawing | Pins | SPQ | Length (mm) | Width (mm) | Height (mm) |
|----------------|--------------|-----------------|------|-----|-------------|------------|-------------|
| DRV5056Z4QDBZT | SOT-23       | DBZ             | 3    | 250 | 213.0       | 191.0      | 35.0        |

# LPG0003A



# PACKAGE OUTLINE

## TO-92 - 5.05 mm max height

TRANSISTOR OUTLINE

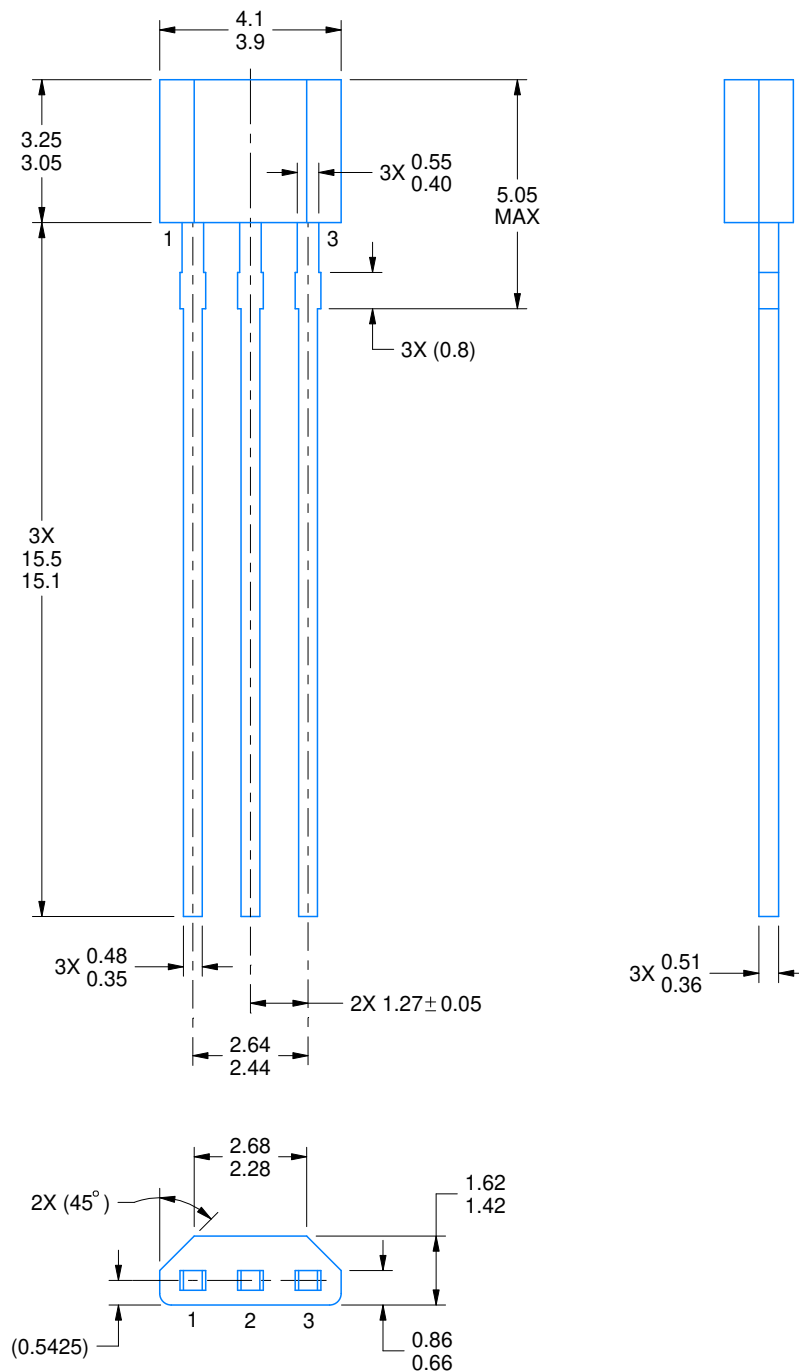

4221343/C 01/2018

### NOTES:

1. All linear dimensions are in millimeters. Any dimensions in parenthesis are for reference only. Dimensioning and tolerancing per ASME Y14.5M.
2. This drawing is subject to change without notice.

# EXAMPLE BOARD LAYOUT

LPG0003A

TO-92 - 5.05 mm max height

TRANSISTOR OUTLINE

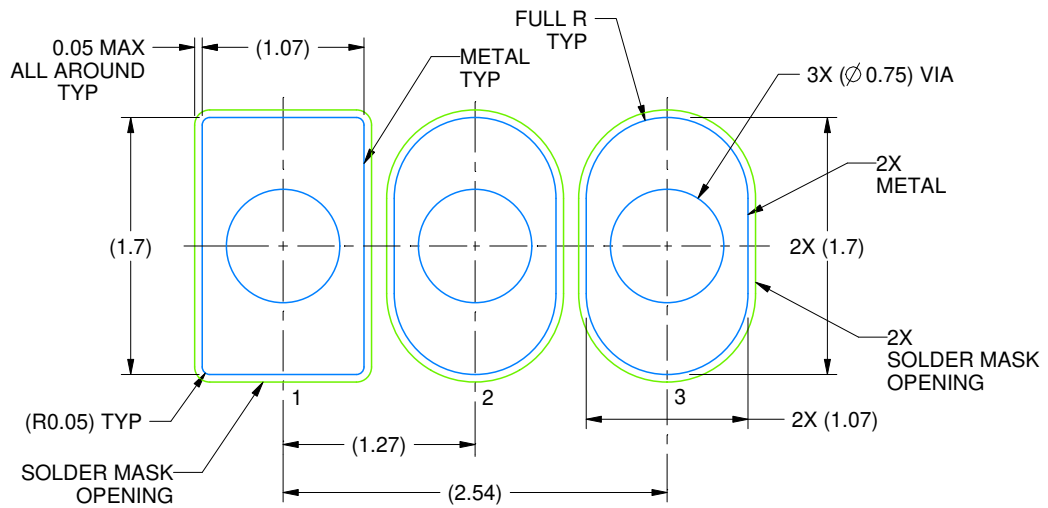

LAND PATTERN EXAMPLE  
NON-SOLDER MASK DEFINED  
SCALE:20X

4221343/C 01/2018

# TAPE SPECIFICATIONS

LPG0003A

TO-92 - 5.05 mm max height

TRANSISTOR OUTLINE

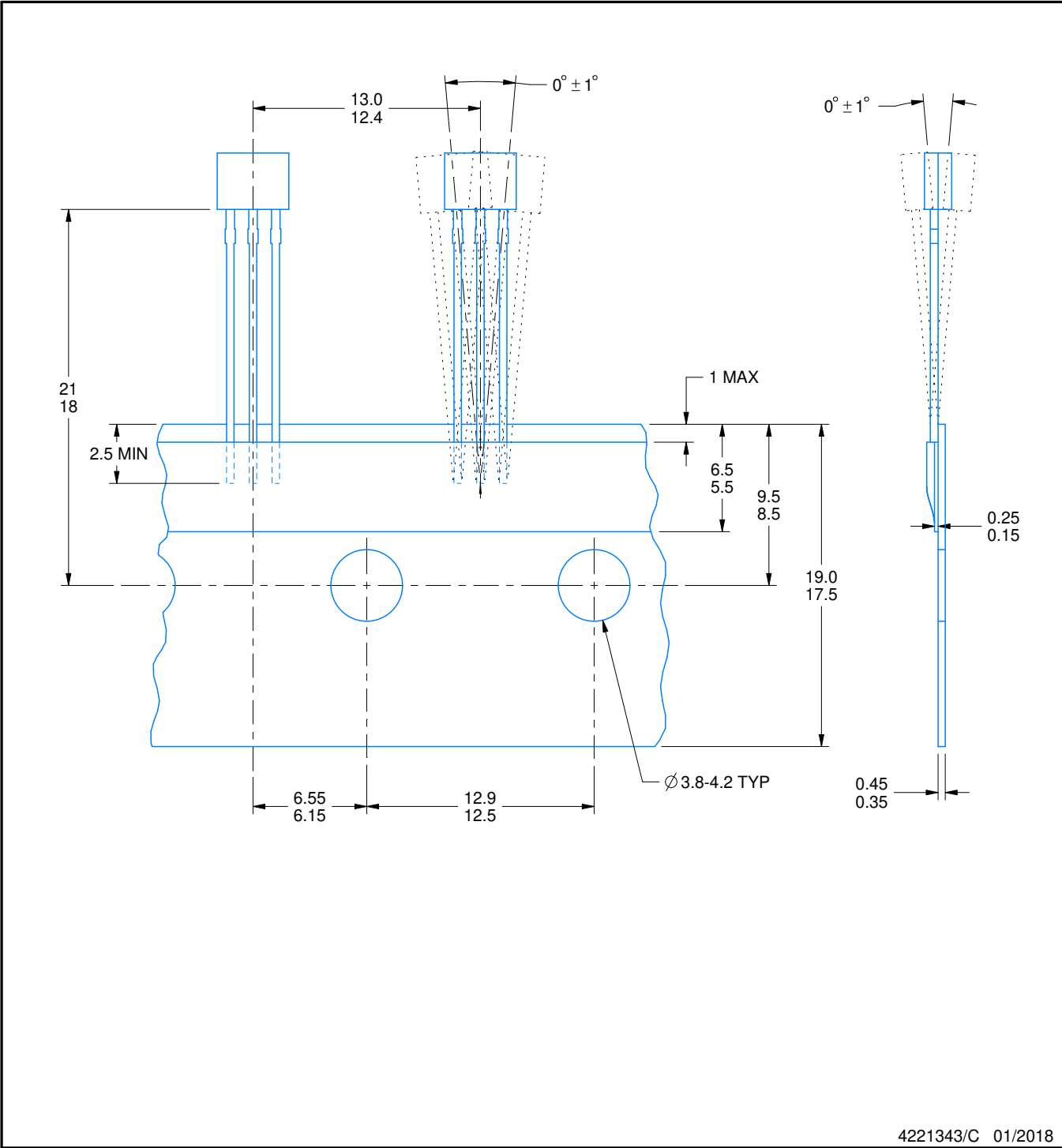

4221343/C 01/2018



# DBZ0003A



# PACKAGE OUTLINE

## SOT-23 - 1.12 mm max height

SMALL OUTLINE TRANSISTOR

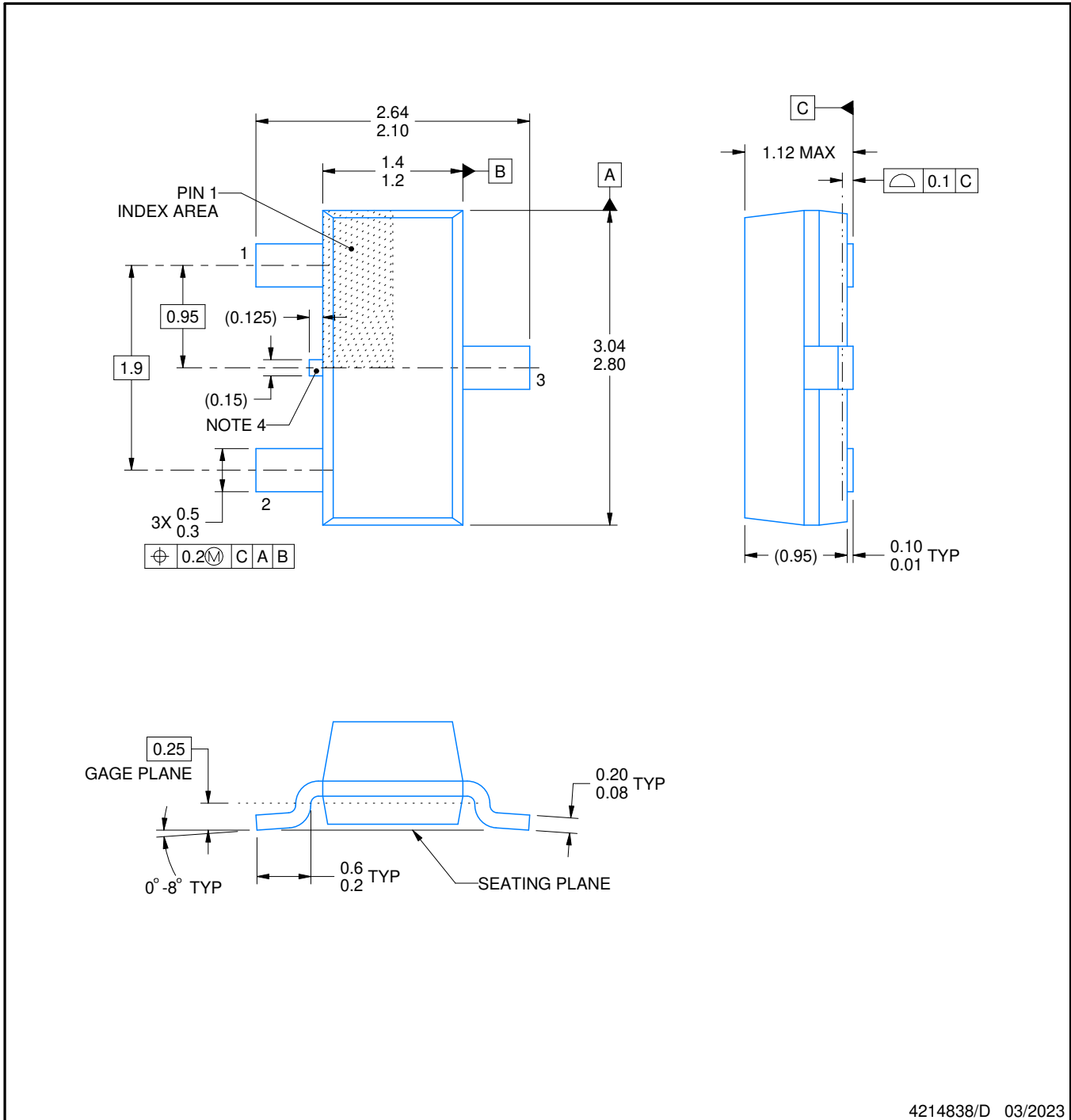

4214838/D 03/2023

### NOTES:

1. All linear dimensions are in millimeters. Any dimensions in parenthesis are for reference only. Dimensioning and tolerancing per ASME Y14.5M.
2. This drawing is subject to change without notice.
3. Reference JEDEC registration TO-236, except minimum foot length.
4. Support pin may differ or may not be present.

# EXAMPLE BOARD LAYOUT

DBZ0003A

SOT-23 - 1.12 mm max height

SMALL OUTLINE TRANSISTOR

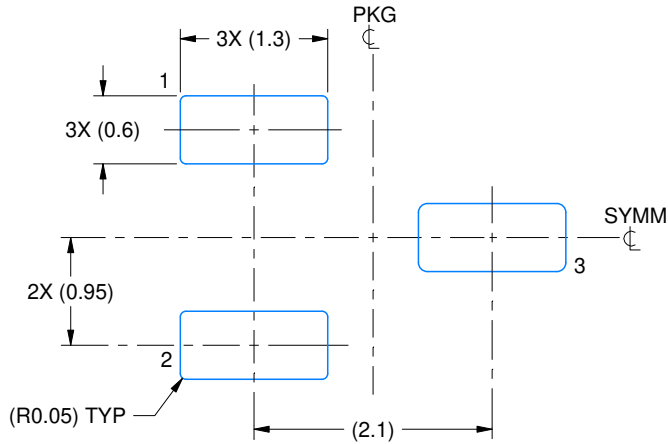

LAND PATTERN EXAMPLE  
SCALE:15X

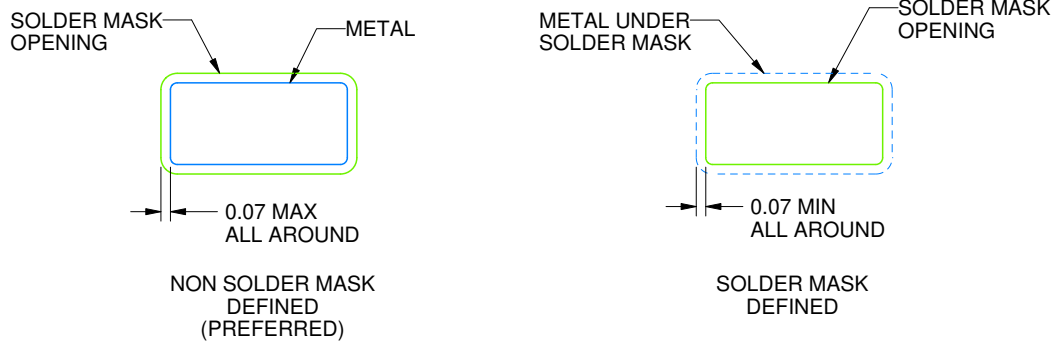

SOLDER MASK DETAILS

4214838/D 03/2023

NOTES: (continued)

4. Publication IPC-7351 may have alternate designs.
5. Solder mask tolerances between and around signal pads can vary based on board fabrication site.

# EXAMPLE STENCIL DESIGN

DBZ0003A

SOT-23 - 1.12 mm max height

SMALL OUTLINE TRANSISTOR

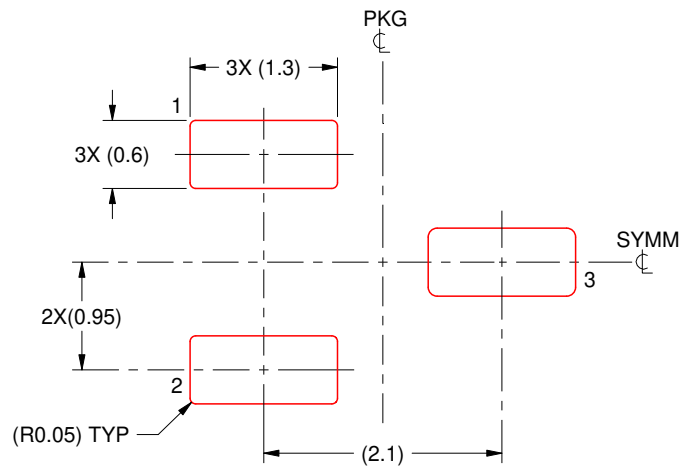

SOLDER PASTE EXAMPLE  
BASED ON 0.125 THICK STENCIL  
SCALE:15X

4214838/D 03/2023

NOTES: (continued)

6. Laser cutting apertures with trapezoidal walls and rounded corners may offer better paste release. IPC-7525 may have alternate design recommendations.
7. Board assembly site may have different recommendations for stencil design.

## IMPORTANT NOTICE AND DISCLAIMER

TI PROVIDES TECHNICAL AND RELIABILITY DATA (INCLUDING DATA SHEETS), DESIGN RESOURCES (INCLUDING REFERENCE DESIGNS), APPLICATION OR OTHER DESIGN ADVICE, WEB TOOLS, SAFETY INFORMATION, AND OTHER RESOURCES "AS IS" AND WITH ALL FAULTS, AND DISCLAIMS ALL WARRANTIES, EXPRESS AND IMPLIED, INCLUDING WITHOUT LIMITATION ANY IMPLIED WARRANTIES OF MERCHANTABILITY, FITNESS FOR A PARTICULAR PURPOSE OR NON-INFRINGEMENT OF THIRD PARTY INTELLECTUAL PROPERTY RIGHTS.

These resources are intended for skilled developers designing with TI products. You are solely responsible for (1) selecting the appropriate TI products for your application, (2) designing, validating and testing your application, and (3) ensuring your application meets applicable standards, and any other safety, security, regulatory or other requirements.

These resources are subject to change without notice. TI grants you permission to use these resources only for development of an application that uses the TI products described in the resource. Other reproduction and display of these resources is prohibited. No license is granted to any other TI intellectual property right or to any third party intellectual property right. TI disclaims responsibility for, and you will fully indemnify TI and its representatives against, any claims, damages, costs, losses, and liabilities arising out of your use of these resources.

TI's products are provided subject to [TI's Terms of Sale](#) or other applicable terms available either on [ti.com](https://www.ti.com) or provided in conjunction with such TI products. TI's provision of these resources does not expand or otherwise alter TI's applicable warranties or warranty disclaimers for TI products.

TI objects to and rejects any additional or different terms you may have proposed.

Mailing Address: Texas Instruments, Post Office Box 655303, Dallas, Texas 75265  
Copyright © 2023, Texas Instruments Incorporated