

## The RF MOSFET Line 15W, to 400MHz, 28V

Rev. V2

Designed for wideband large signal amplifier and oscillator applications  
Up to 400 MHz range, in single-ended configuration

N-Channel enhancement mode

- Guaranteed 28 volt, 150 MHz performance  
Output power = 15 watts  
Narrowband gain = 16 dB (Typ.)  
Efficiency = 60% (Typ.)
- Small- and large-signal characterization
- 100% tested for load mismatch at all phase angles with 30:1 VSWR
- Excellent thermal stability, ideally suited for Cass A operation
- Facilitates manual gain control, ALC and modulation techniques

### Product Image

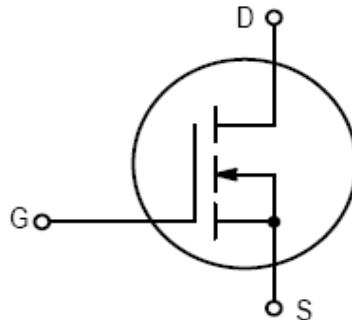
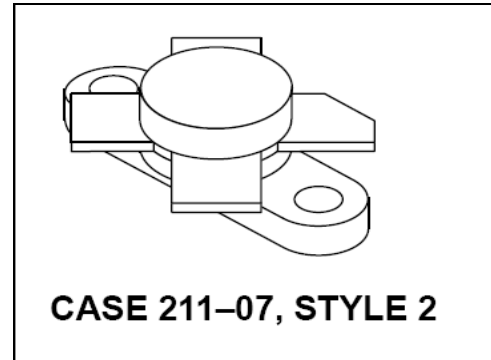

### MAXIMUM RATINGS

Rating	Symbol	Value	Unit
Drain-Source Voltage	$V_{DSS}$	65	Vdc
Drain-Gate Voltage ( $R_{GS} = 1.0 \text{ M}\Omega$ )	$V_{DGR}$	65	Vdc
Gate-Source Voltage	$V_{GS}$	$\pm 40$	Vdc
Drain Current — Continuous	$I_D$	2.5	Adc
Total Device Dissipation @ $T_C = 25^\circ\text{C}$ Derate above $25^\circ\text{C}$	$P_D$	55 0.314	Watts W/ $^\circ\text{C}$
Storage Temperature Range	$T_{stg}$	-65 to +150	$^\circ\text{C}$
Operating Junction Temperature	$T_J$	200	$^\circ\text{C}$

### THERMAL CHARACTERISTICS

Characteristic	Symbol	Max	Unit
Thermal Resistance, Junction to Case	$R_{\theta JC}$	3.2	$^\circ\text{C}/\text{W}$

**NOTE – CAUTION** – MOS devices are susceptible to damage from electrostatic charge. Reasonable precautions in handling and packaging MOS devices should be observed.

**ELECTRICAL CHARACTERISTICS** ( $T_C = 25^\circ\text{C}$  unless otherwise noted.)

Characteristic	Symbol	Min	Typ	Max	Unit
----------------	--------	-----	-----	-----	------

**OFF CHARACTERISTICS (1)**

Drain-Source Breakdown Voltage ( $V_{GS} = 0, I_D = 5.0 \text{ mA}$ )	$V_{(BR)DSS}$	65	—	—	Vdc
Zero-Gate Voltage Drain Current ( $V_{DS} = 28 \text{ V}, V_{GS} = 0$ )	$I_{DSS}$	—	—	2.0	mAdc
Gate-Source Leakage Current ( $V_{GS} = 40 \text{ V}, V_{DS} = 0$ )	$I_{GSS}$	—	—	1.0	$\mu\text{Adc}$

**ON CHARACTERISTICS (1)**

Gate Threshold Voltage ( $V_{DS} = 10 \text{ V}, I_D = 25 \text{ mA}$ )	$V_{GS(th)}$	1.0	3.0	6.0	Vdc
Forward Transconductance ( $V_{DS} = 10 \text{ V}, I_D = 250 \text{ mA}$ )	$g_{fs}$	250	400	—	mmhos

**DYNAMIC CHARACTERISTICS (1)**

Input Capacitance ( $V_{DS} = 28 \text{ V}, V_{GS} = 0, f = 1.0 \text{ MHz}$ )	$C_{iss}$	—	24	—	pF
Output Capacitance ( $V_{DS} = 28 \text{ V}, V_{GS} = 0, f = 1.0 \text{ MHz}$ )	$C_{oss}$	—	27	—	pF
Reverse Transfer Capacitance ( $V_{DS} = 28 \text{ V}, V_{GS} = 0, f = 1.0 \text{ MHz}$ )	$C_{rss}$	—	5.5	—	pF

**FUNCTIONAL CHARACTERISTICS**

Noise Figure ( $V_{DS} = 28 \text{ Vdc}, I_D = 500 \text{ mA}, f = 150 \text{ MHz}$ )	NF	—	1.0	—	dB
Common Source Power Gain (Figure 1) ( $V_{DD} = 28 \text{ Vdc}, P_{out} = 15 \text{ W}, f = 150 \text{ MHz}, I_{DQ} = 25 \text{ mA}$ )	$G_{ps}$	13	16	—	dB
Drain Efficiency (Figure 1) ( $V_{DD} = 28 \text{ Vdc}, P_{out} = 15 \text{ W}, f = 150 \text{ MHz}, I_{DQ} = 25 \text{ mA}$ )	$\eta$	50	60	—	%
Electrical Ruggedness (Figure 1) ( $V_{DD} = 28 \text{ Vdc}, P_{out} = 15 \text{ W}, f = 150 \text{ MHz}, I_{DQ} = 25 \text{ mA},$ $V_{SWR} 30:1$ at all Phase Angles)	$\psi$	No Degradation in Output Power			

NOTES:

1. Each side measured separately.

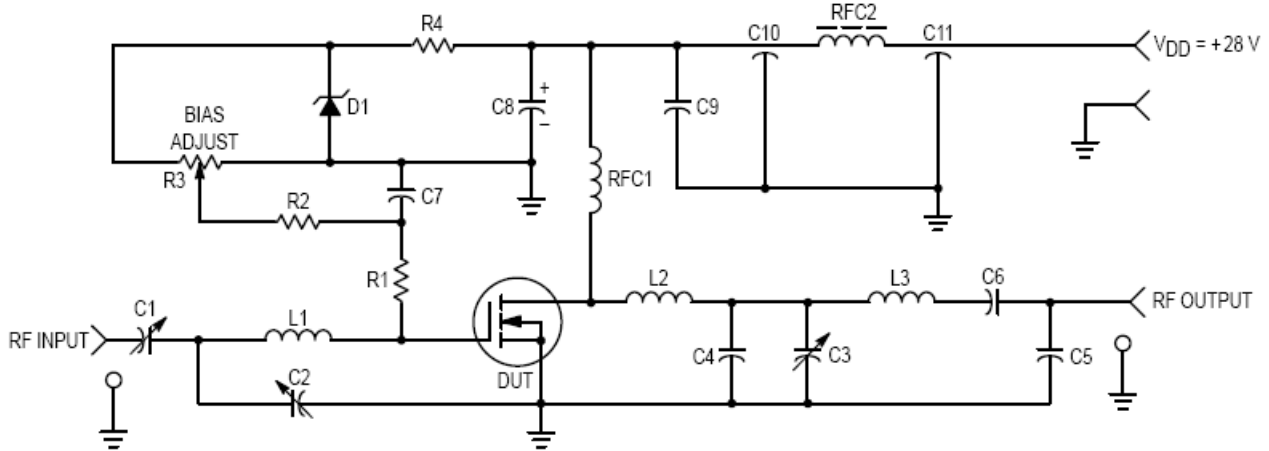

C1, C2 — Arco 406, 15–115 pF or Equivalent  
 C3 — Arco 404, 8–60 pF or Equivalent  
 C4 — 43 pF Mini-Unelco or Equivalent  
 C5 — 24 pF Mini-Unelco or Equivalent  
 C6 — 680 pF, 100 Mils Chip  
 C7 — 0.01  $\mu$ F Ceramic  
 C8 — 100  $\mu$ F, 40 V  
 C9 — 0.1  $\mu$ F Ceramic  
 C10, C11 — 680 pF Feedthru  
 D1 — 1N5925A Motorola Zener

L1 — 2 Turns, 0.29" ID, #18 AWG, 0.10" Long  
 L2 — 2 Turns, 0.23" ID, #18 AWG, 0.10" Long  
 L3 — 2–1/4 Turns, 0.29" ID, #18 AWG, 0.125" Long  
 RFC1 — 20 Turns, 0.30" ID, #20 AWG Enamel Closewound  
 RFC2 — Ferroxcube VK-200 — 19/4B  
 R1 — 27  $\Omega$ , 1 W Thin Film  
 R2 — 10 k $\Omega$ , 1/4 W  
 R3 — 10 Turns, 10 k $\Omega$   
 R4 — 1.8 k $\Omega$ , 1/2 W  
 Board Material — 0.062" G10, 1 oz. Cu Clad, Double Sided

Figure 1. 150 MHz Test Circuit

## TYPICAL CHARACTERISTICS

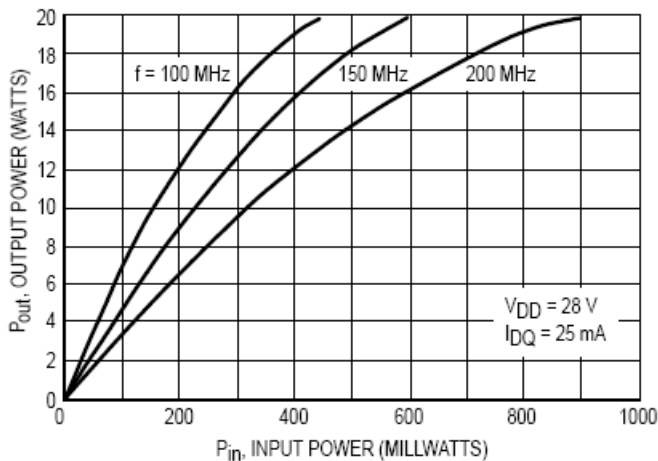

Figure 2. Output Power versus Input Power

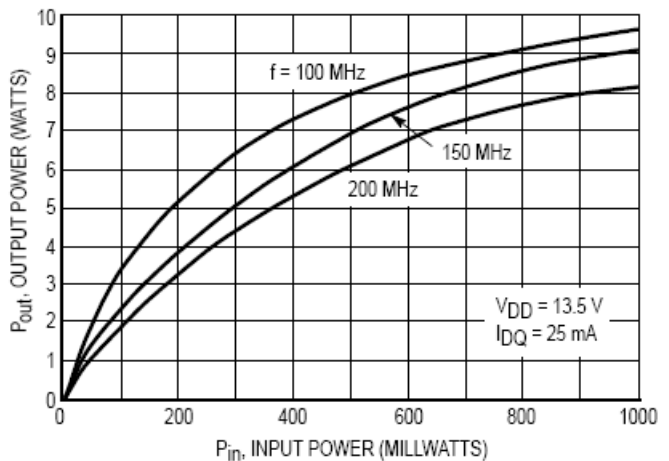

Figure 3. Output Power versus Input Power

## TYPICAL CHARACTERISTICS

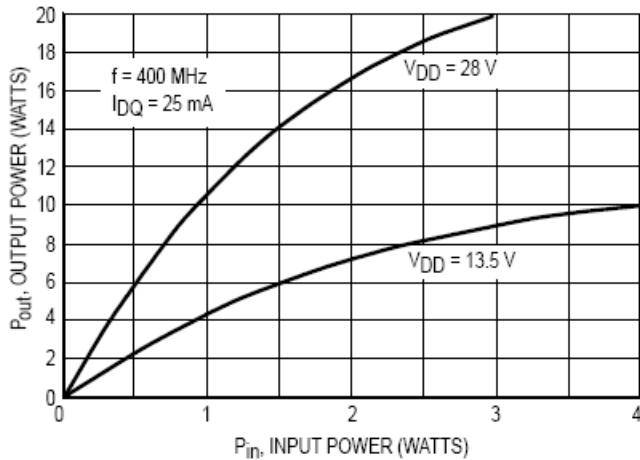

Figure 4. Output Power versus Input Power

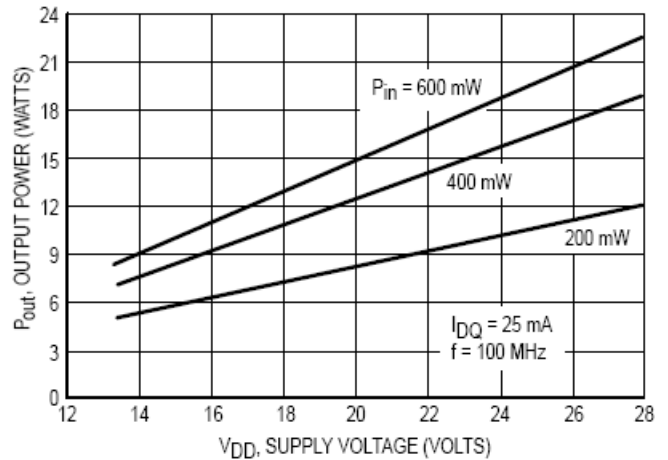

Figure 5. Output Power versus Supply Voltage

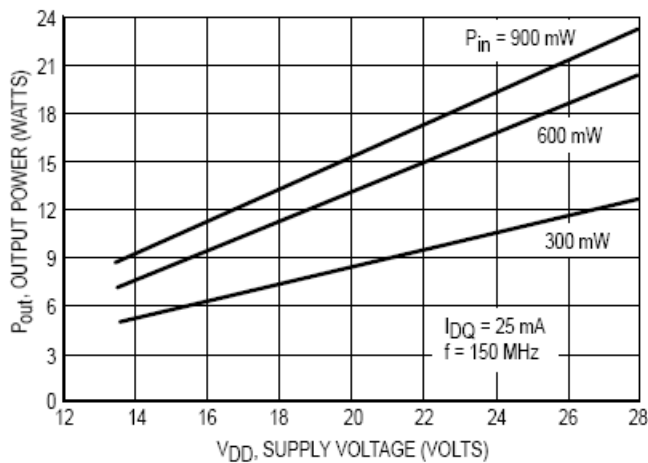

Figure 6. Output Power versus Supply Voltage

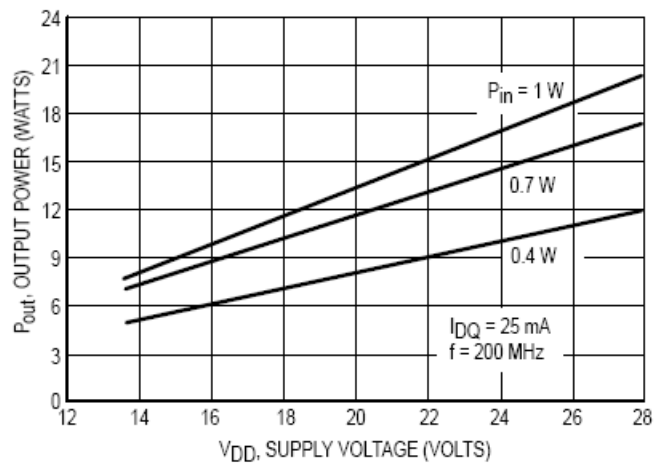

Figure 7. Output Power versus Supply Voltage

## TYPICAL CHARACTERISTICS

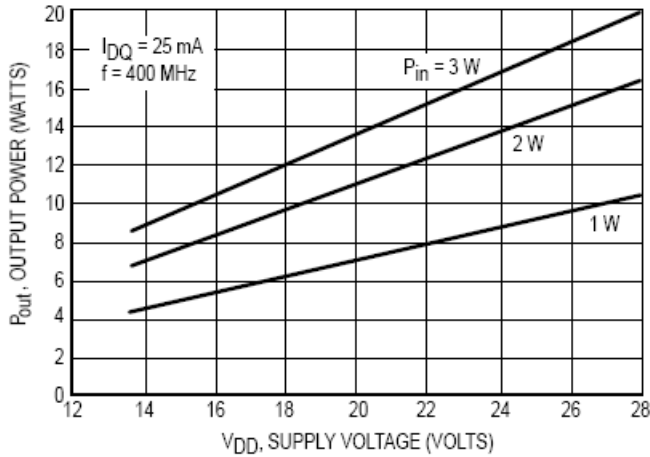

Figure 8. Output Power versus Supply Voltage

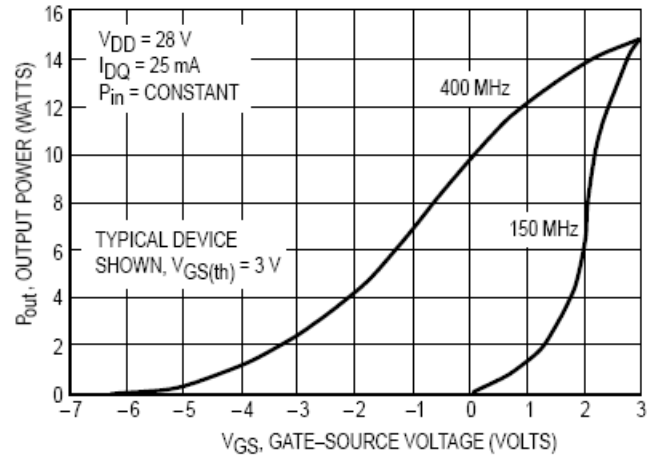

Figure 9. Output Power versus Gate Voltage

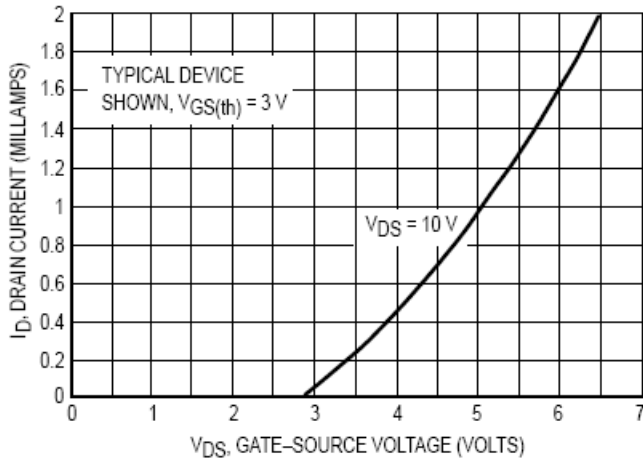

Figure 10. Drain Current versus Gate Voltage (Transfer Characteristics)

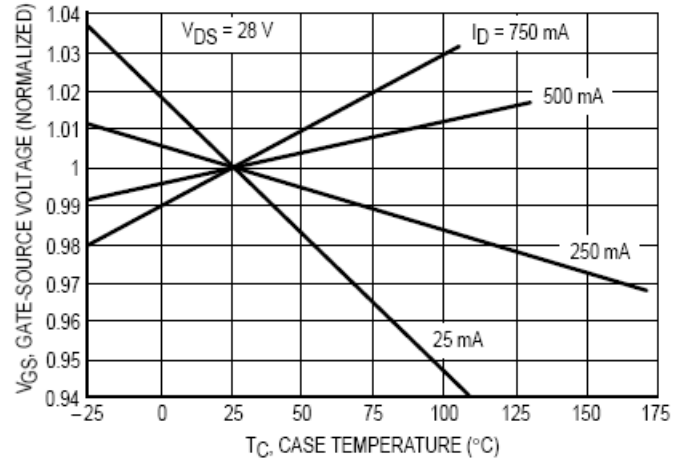

Figure 11. Gate-Source Voltage versus Case Temperature

## TYPICAL CHARACTERISTICS

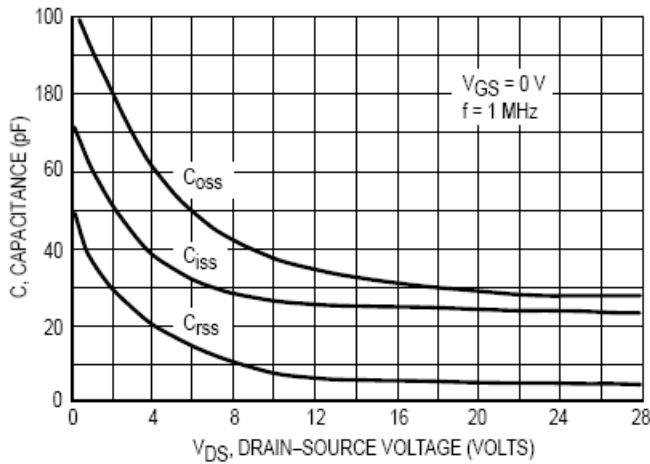

Figure 12. Capacitance versus Drain-Source Voltage

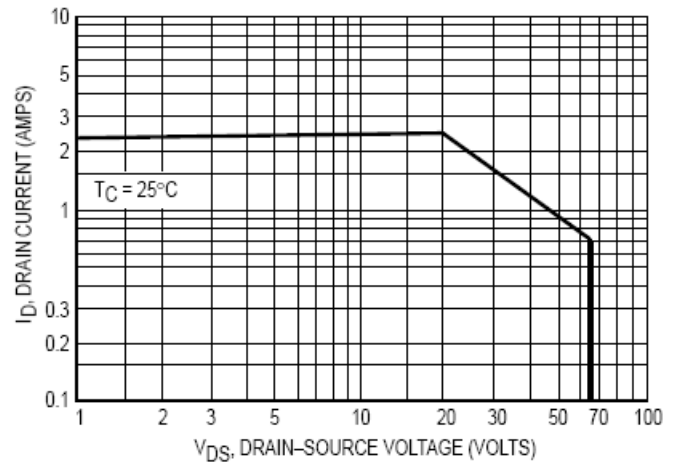

Figure 13. DC Safe Operating Area

## TYPICAL 400 MHz PERFORMANCE

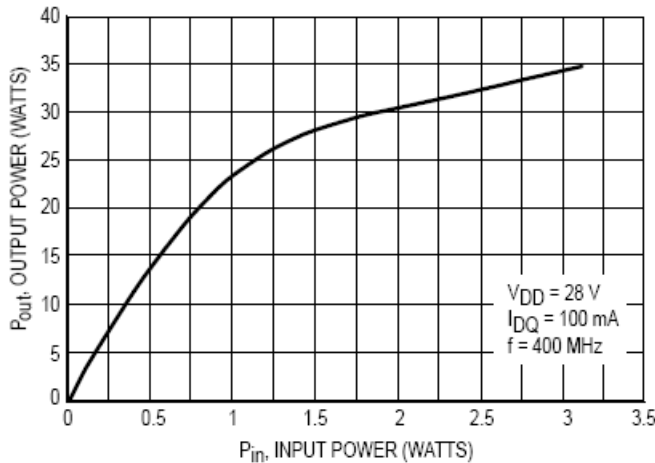

Figure 14. Output Power versus Input Power

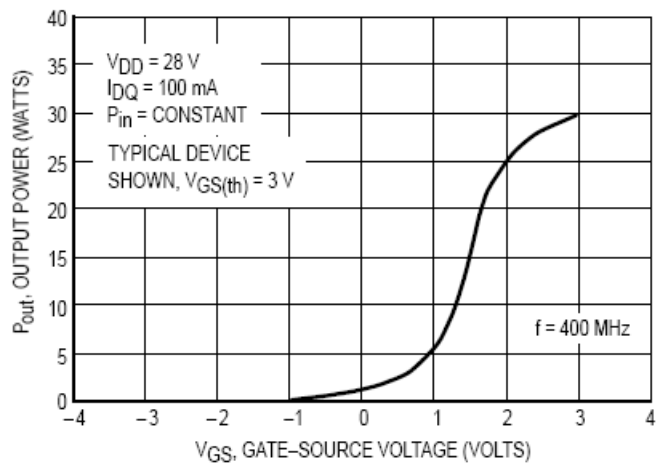

Figure 15. Output Power versus Gate Voltage

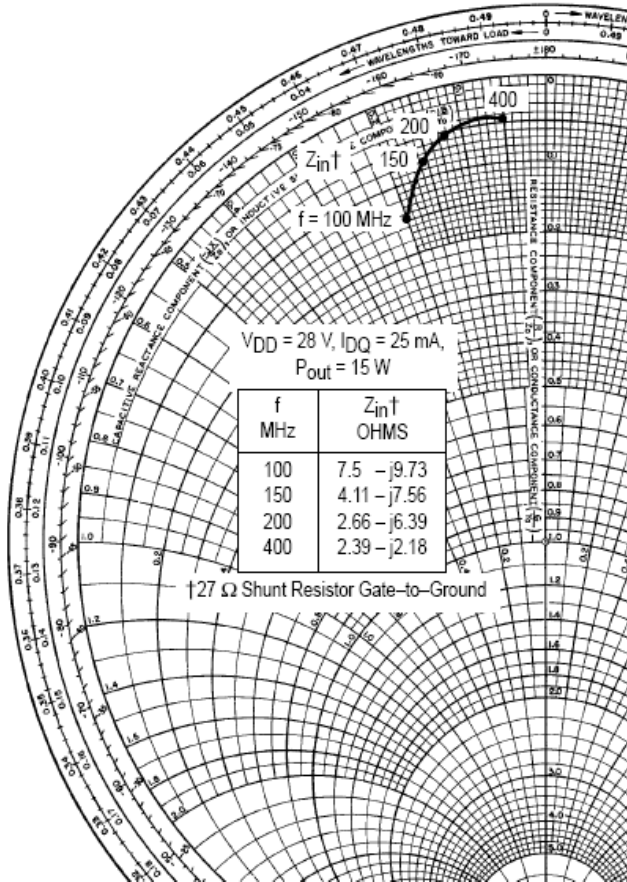

Figure 16. Large-Signal Series Equivalent Input Impedance,  $Z_{in}\dagger$

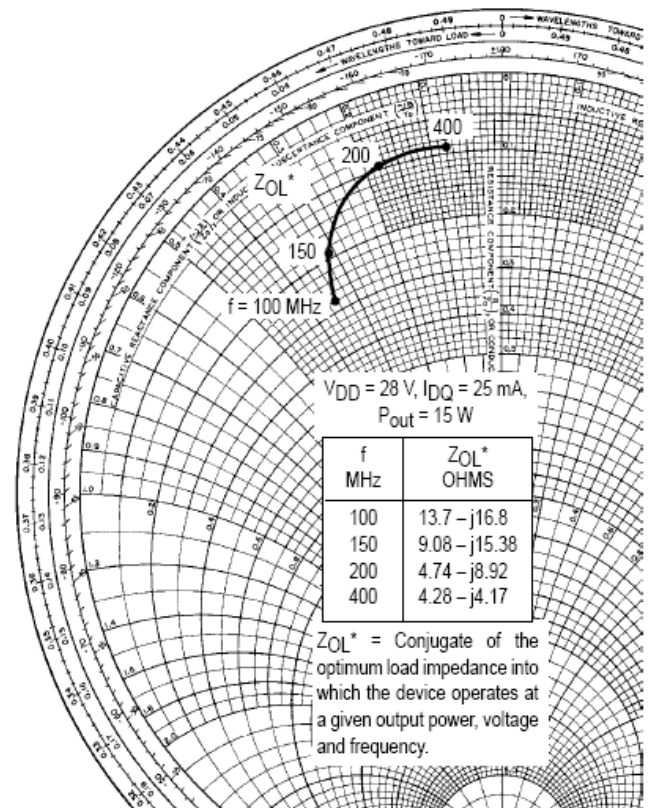

Figure 17. Large-Signal Series Equivalent Output Impedance,  $Z_{OL}^*$



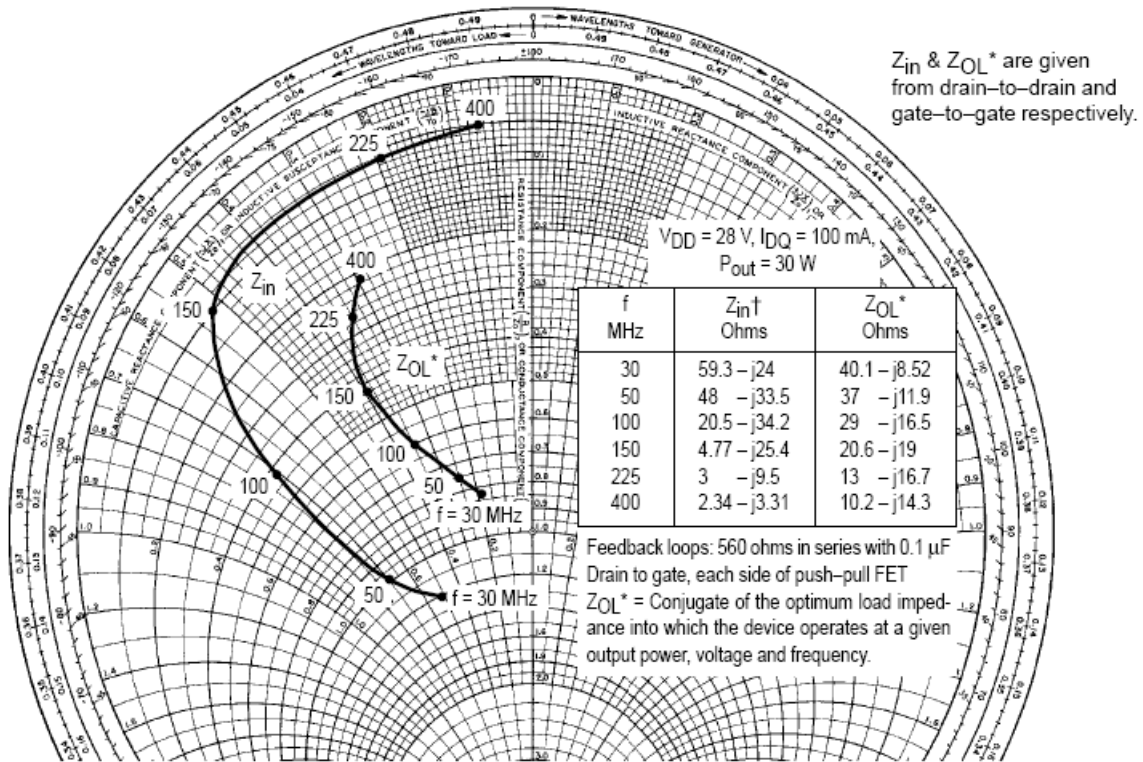
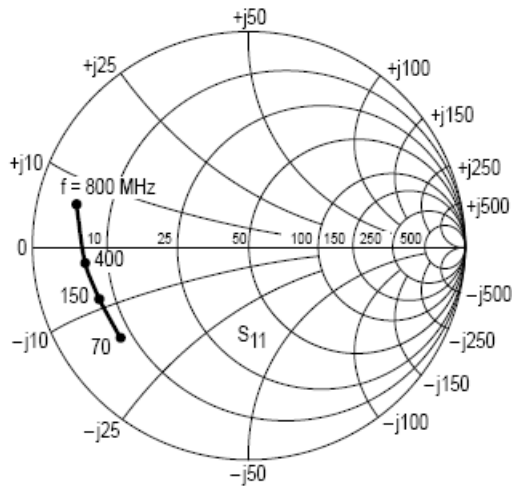

Figure 18. Input and Outut Impedance



f (MHz)	S <sub>11</sub>		S <sub>21</sub>		S <sub>12</sub>		S <sub>22</sub>	
	S <sub>11</sub>	∠	S <sub>21</sub>	∠	S <sub>12</sub>	∠	S <sub>22</sub>	∠
2.0	0.988	-11	41.19	173	0.006	67	0.729	-12
5.0	0.970	-27	40.07	164	0.014	62	0.720	-31
10	0.923	-52	35.94	149	0.026	54	0.714	-58
20	0.837	-88	27.23	129	0.040	36	0.690	-96
30	0.784	-111	20.75	117	0.046	27	0.684	-118
40	0.751	-125	16.49	108	0.048	22	0.680	-131
50	0.733	-135	13.41	103	0.050	19	0.679	-139
60	0.720	-142	11.43	99	0.050	16	0.678	-145
70	0.709	-147	9.871	96	0.050	14	0.679	-149
80	0.707	-152	8.663	93	0.051	13	0.683	-153
90	0.706	-155	7.784	91	0.051	13	0.682	-155
100	0.708	-157	7.008	88	0.051	13	0.680	-157
110	0.711	-159	6.435	86	0.051	14	0.681	-158
120	0.714	-161	5.899	85	0.051	15	0.682	-159
130	0.717	-163	5.439	82	0.052	16	0.684	-160
140	0.720	-164	5.068	80	0.052	17	0.684	-161
150	0.723	-165	4.709	80	0.052	18	0.686	-161
160	0.727	-166	4.455	78	0.052	18	0.690	-161
170	0.732	-167	4.200	77	0.052	18	0.694	-162
180	0.735	-168	3.967	75	0.052	19	0.699	-162
190	0.738	-169	3.756	74	0.052	19	0.703	-163
200	0.740	-170	3.545	73	0.052	20	0.706	-163
225	0.746	-171	3.140	69	0.053	22	0.717	-163
250	0.742	-172	2.783	67	0.053	25	0.724	-163
275	0.744	-173	2.540	64	0.054	27	0.724	-163
300	0.751	-174	2.323	60	0.055	29	0.736	-163
325	0.757	-175	2.140	58	0.058	32	0.749	-163
350	0.760	-176	1.963	54	0.059	35	0.758	-163
375	0.762	-177	1.838	52	0.062	38	0.768	-163
400	0.774	-179	1.696	50	0.065	41	0.783	-163
425	0.775	-179	1.590	48	0.068	43	0.793	-163
450	0.781	+179	1.493	46	0.071	46	0.805	-163
475	0.787	+177	1.415	43	0.074	47	0.813	-164
500	0.792	+176	1.332	40	0.079	48	0.825	-164
525	0.797	+175	1.259	38	0.083	50	0.831	-164
550	0.801	+175	1.185	37	0.088	51	0.843	-164
575	0.810	+174	1.145	36	0.094	52	0.855	-164
600	0.816	+173	1.091	34	0.101	52	0.869	-165
625	0.818	+171	1.041	32	0.106	53	0.871	-165
650	0.825	+170	0.994	30	0.112	53	0.884	-165
675	0.834	+169	0.962	29	0.119	53	0.890	-165
700	0.837	+168	0.922	27	0.127	53	0.906	-166
725	0.836	+167	0.879	25	0.133	52	0.909	-167
750	0.841	+166	0.838	25	0.140	53	0.917	-167
775	0.844	+165	0.824	24	0.148	52	0.933	-167
800	0.846	+163	0.785	21	0.154	50	0.941	-168

Table 1. Common Source Scattering Parameters  
V<sub>DS</sub> = 28 V, I<sub>D</sub> = 0.5 A



**Figure 19.  $S_{11}$ , Input Reflection Coefficient versus Frequency**  
 $V_{DS} = 28\text{ V}$   $I_D = 0.5\text{ A}$

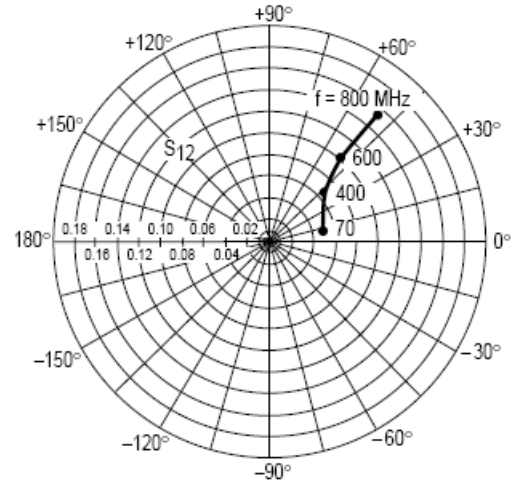

**Figure 20.  $S_{12}$ , Reverse Transmission Coefficient versus Frequency**  
 $V_{DS} = 28\text{ V}$   $I_D = 0.5\text{ A}$

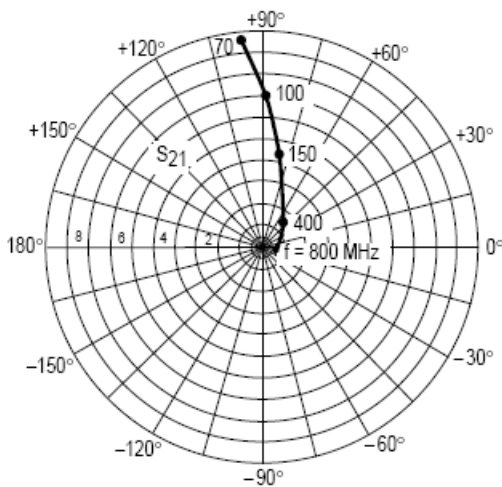

**Figure 21.  $S_{21}$ , Forward Transmission Coefficient versus Frequency**  
 $V_{DS} = 28\text{ V}$   $I_D = 0.5\text{ A}$

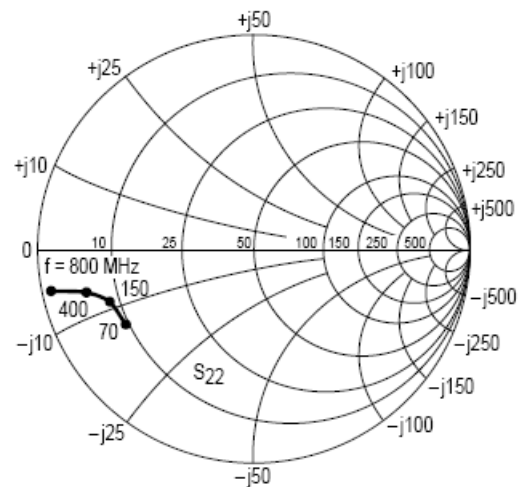

**Figure 22.  $S_{22}$ , Output Reflection Coefficient versus Frequency**  
 $V_{DS} = 28\text{ V}$   $I_D = 0.5\text{ A}$

## RF POWER MOSFET CONSIDERATIONS

### DESIGN CONSIDERATIONS

The MRF137 is a RF power N-Channel enhancement-mode field-effect transistor (FET) designed especially for VHF power amplifier applications. M/A-COM RF MOS FETs feature a vertical structure with a planar design, thus avoiding the processing difficulties associated with V-groove vertical power FETs.

M/A-COM Application Note AN211A, FETs in Theory and Practice, is suggested reading for those not familiar with the construction and characteristics of FETs.

The major advantages of RF power FETs include high gain, low noise, simple bias systems, relative immunity from thermal runaway, and the ability to withstand severely mismatched loads without suffering damage. Power output can be varied over a wide range with a low power dc control signal, thus facilitating manual gain control, ALC and modulation.

### DC BIAS

The MRF137 is an enhancement mode FET and, therefore, does not conduct when drain voltage is applied. Drain current flows when a positive voltage is applied to the gate. See Figure 10 for a typical plot of drain current versus gate voltage. RF power FETs require forward bias for optimum performance.

The value of quiescent drain current ( $I_{DQ}$ ) is not critical for many applications. The MRF137 was characterized at  $I_{DQ} = 25$  mA, which is the suggested minimum value of  $I_{DQ}$ . For special applications such as linear amplification,  $I_{DQ}$  may have to be selected to optimize the critical parameters.

The gate is a dc open circuit and draws no current. Therefore, the gate bias circuit may generally be just a simple

resistive divider network. Some special applications may require a more elaborate bias system.

### GAIN CONTROL

Power output of the MRF137 may be controlled from its rated value down to zero (negative gain) by varying the dc gate voltage. This feature facilitates the design of manual gain control, AGC/ALC and modulation systems. (See Figure 9.)

### AMPLIFIER DESIGN

Impedance matching networks similar to those used with bipolar VHF transistors are suitable for MRF137. See M/A-COM Application Note AN721, Impedance Matching Networks Applied to RF Power Transistors. The higher input impedance of RF MOS FETs helps ease the task of broadband network design. Both small signal scattering parameters and large signal impedances are provided. While the s-parameters will not produce an exact design solution for high power operation, they do yield a good first approximation. This is an additional advantage of RF MOS power FETs.

RF power FETs are triode devices and, therefore, not unilateral. This, coupled with the very high gain of the MRF137, yields a device capable of self oscillation. Stability may be achieved by techniques such as drain loading, input shunt resistive loading, or output to input feedback. Two port parameter stability analysis with the MRF137 s-parameters provides a useful tool for selection of loading or feedback circuitry to assure stable operation. See M/A-COM Application Note AN215A for a discussion of two port network theory and stability.

### LOW NOISE OPERATION

Input resistive loading will degrade noise performance, and noise figure may vary significantly with gate driving impedance. A low loss input matching network with its gate impedance optimized for lowest noise is recommended.

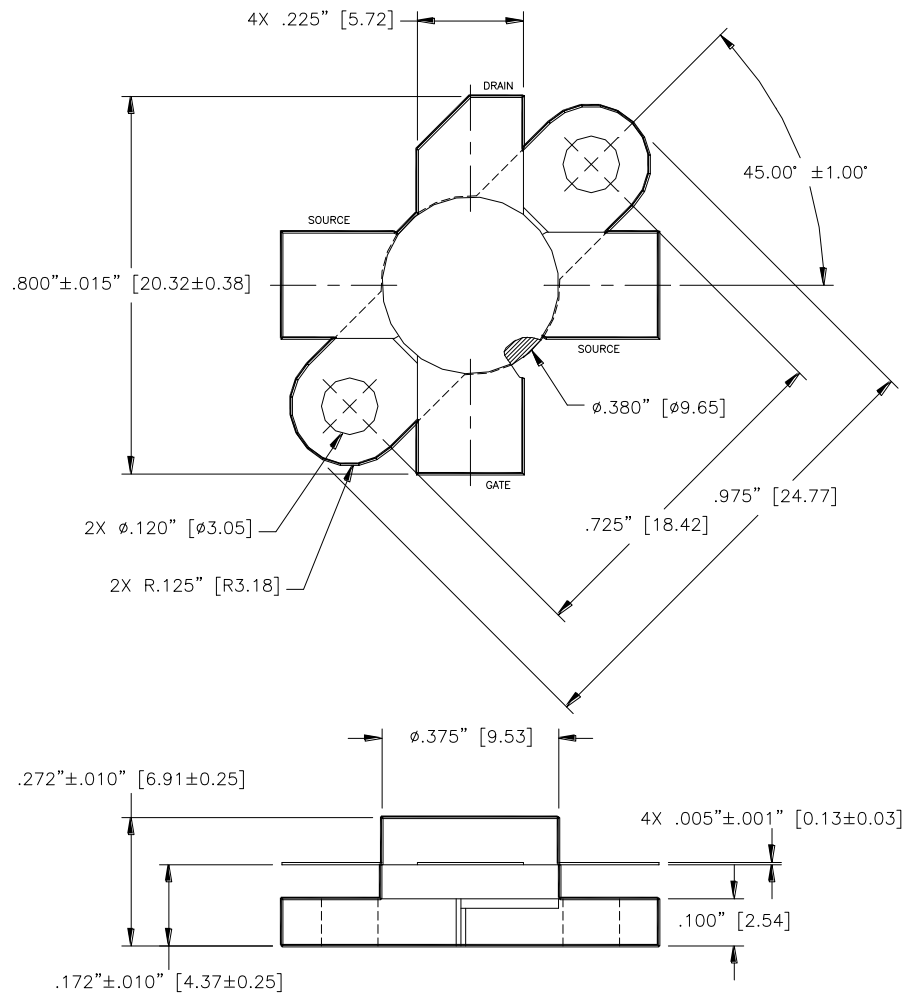

Unless otherwise noted, tolerances are inches ±.005" [millimeters ±0.13mm]

M/A-COM Technology Solutions Inc. All rights reserved.

Information in this document is provided in connection with M/A-COM Technology Solutions Inc ("MACOM") products. These materials are provided by MACOM as a service to its customers and may be used for informational purposes only. Except as provided in MACOM's Terms and Conditions of Sale for such products or in any separate agreement related to this document, MACOM assumes no liability whatsoever. MACOM assumes no responsibility for errors or omissions in these materials. MACOM may make changes to specifications and product descriptions at any time, without notice. MACOM makes no commitment to update the information and shall have no responsibility whatsoever for conflicts or incompatibilities arising from future changes to its specifications and product descriptions. No license, express or implied, by estoppel or otherwise, to any intellectual property rights is granted by this document.

THESE MATERIALS ARE PROVIDED "AS IS" WITHOUT WARRANTY OF ANY KIND, EITHER EXPRESS OR IMPLIED, RELATING TO SALE AND/OR USE OF MACOM PRODUCTS INCLUDING LIABILITY OR WARRANTIES RELATING TO FITNESS FOR A PARTICULAR PURPOSE, CONSEQUENTIAL OR INCIDENTAL DAMAGES, MERCHANTABILITY, OR INFRINGEMENT OF ANY PATENT, COPYRIGHT OR OTHER INTELLECTUAL PROPERTY RIGHT. MACOM FURTHER DOES NOT WARRANT THE ACCURACY OR COMPLETENESS OF THE INFORMATION, TEXT, GRAPHICS OR OTHER ITEMS CONTAINED WITHIN THESE MATERIALS. MACOM SHALL NOT BE LIABLE FOR ANY SPECIAL, INDIRECT, INCIDENTAL, OR CONSEQUENTIAL DAMAGES, INCLUDING WITHOUT LIMITATION, LOST REVENUES OR LOST PROFITS, WHICH MAY RESULT FROM THE USE OF THESE MATERIALS.

MACOM products are not intended for use in medical, lifesaving or life sustaining applications. MACOM customers using or selling MACOM products for use in such applications do so at their own risk and agree to fully indemnify MACOM for any damages resulting from such improper use or sale.