

FEATURES

- Tiny, 3.35 mm × 2.5 mm × 0.98 mm surface-mount package
- Noninverted signal output
- Omnidirectional response
- High SNR of 65 dBA
- Sensitivity of -38 dBV
- Sensitivity tolerance of ±2 dB
- Extended frequency response from 60 Hz to 20 kHz
- Enhanced radio frequency (RF) performance
- Acoustic overload point of 124 dB SPL
- Low current consumption of 180 µA
- Single-ended analog output
- High PSR of -78 dBV
- Compatible with Sn/Pb and Pb-free solder processes
- RoHS/WEEE compliant

APPLICATIONS

- Smartphones and feature phones
- Tablet computers
- Teleconferencing systems
- Digital still and video cameras
- Bluetooth headsets
- Notebook PCs
- Security and surveillance

GENERAL DESCRIPTION

The **ADMP510**¹ is an RF hardened, analog output, bottom-ported, omnidirectional MEMS microphone with high performance, ultralow noise, and low power. The **ADMP510** consists of a MEMS microphone element, an impedance converter, and an output amplifier. The **ADMP510** sensitivity specification makes it an excellent choice for both near-field and far-field applications. The **ADMP510** is pin compatible with the **ADMP504** microphone.

FUNCTIONAL BLOCK DIAGRAM

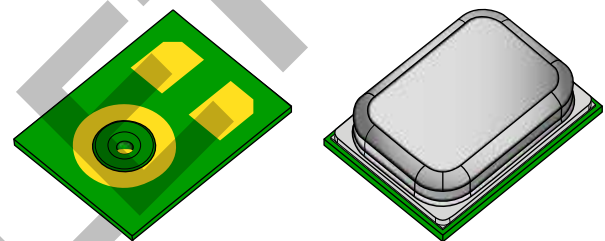
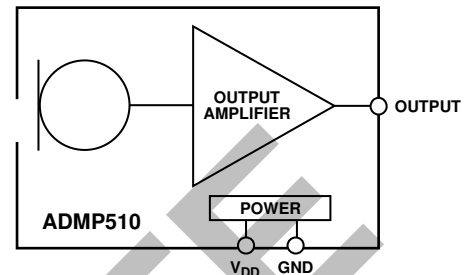

Figure 2. Isometric Views of the Microphone Package

The **ADMP510** has a very high signal-to-noise ratio (SNR) and extended wideband frequency response, resulting in natural sound with high intelligibility. Low current consumption enables long battery life for portable applications.

The **ADMP510** is available in an ultraminiature 3.35 mm × 2.5 mm × 0.98 mm surface-mount package. It is reflow solder compatible with no sensitivity degradation.

¹ Protected by U.S. Patents 7,449,356; 7,825,484; 7,885,423; and 7,961,897. Other patents are pending.

TABLE OF CONTENTS

Features	1	Applications Information	7
Applications	1	Interfacing with Analog Devices Codecs	7
Functional Block Diagram	1	Supporting Documents	7
General Description	1	PCB Design and Land Pattern Layout	8
Revision History	2	Handling Instructions	9
Specifications	3	Pick-and-Place Equipment	9
Absolute Maximum Ratings	4	Reflow Solder	9
ESD Caution	4	Board Wash	9
Soldering Profile	4	Outline Dimensions	10
Pin Configuration and Function Descriptions	5	Ordering Guide	10
Typical Performance Characteristics	6		

REVISION HISTORY

10/13—Rev. 0 to Rev. A	
Change to Figure 5	6

7/13—Revision 0: Initial Version

SPECIFICATIONS

$T_A = 25^\circ\text{C}$, $V_{DD} = 1.8\text{ V}$, unless otherwise noted. All minimum and maximum specifications are guaranteed. Typical specifications are not guaranteed.

Table 1.

Parameter	Symbol	Test Conditions/Comments	Min	Typ	Max	Unit
PERFORMANCE						
Directionality				Omni		
Output Polarity				Noninverted		
Sensitivity		1 kHz, 94 dB sound pressure level (SPL)	-40	-38	-36	dBV
Signal-to-Noise Ratio	SNR	20 Hz to 20 kHz, A-weighted		65		dBA
Equivalent Input Noise	EIN	20 Hz to 20 kHz, A-weighted		29		dBA SPL
Dynamic Range		Derived from EIN and maximum acoustic input		91		dB
Frequency Response ¹		Low frequency -3 dB point		60		Hz
		High frequency -3 dB point		>20		kHz
Total Harmonic Distortion	THD	105 dB SPL		0.2	1	%
Power Supply Rejection	PSR	217 Hz, 100 mV p-p square wave superimposed on $V_{DD} = 1.8\text{ V}$ (A-weighted)		-78		dBV
Power Supply Rejection Ratio	PSRR	1 kHz, 100 mV p-p sine wave superimposed on $V_{DD} = 1.8\text{ V}$		-55		dB
Acoustic Overload Point		10% THD		124		dB SPL
POWER SUPPLY						
Supply Voltage	V_{DD}		1.5		3.63	V
Supply Current	I_S	$V_{DD} = 1.8\text{ V}$		180	220	μA
		$V_{DD} = 3.3\text{ V}$		210	250	μA
OUTPUT CHARACTERISTICS						
Output Impedance	Z_{OUT}			350		Ω
Output DC Offset				0.7		V
Maximum Output Voltage		124 dB SPL input		0.398		V rms
Noise Floor		20 Hz to 20 kHz, A-weighted, rms		-103		dBV

¹ See Figure 5 and Figure 6.

ABSOLUTE MAXIMUM RATINGS

Table 2.

Parameter	Rating
Supply Voltage	-0.3 V to +3.63 V
Sound Pressure Level (SPL)	160 dB
Mechanical Shock	10,000 g
Vibration	Per MIL-STD-883 Method 2007, Test Condition B
Temperature Range	-40°C to +85°C

Stresses above those listed under Absolute Maximum Ratings may cause permanent damage to the device. This is a stress rating only; functional operation of the device at these or any other conditions above those indicated in the operational section of this specification is not implied. Exposure to absolute maximum rating conditions for extended periods may affect device reliability.

ESD CAUTION



ESD (electrostatic discharge) sensitive device. Charged devices and circuit boards can discharge without detection. Although this product features patented or proprietary protection circuitry, damage may occur on devices subjected to high energy ESD. Therefore, proper ESD precautions should be taken to avoid performance degradation or loss of functionality.

SOLDERING PROFILE

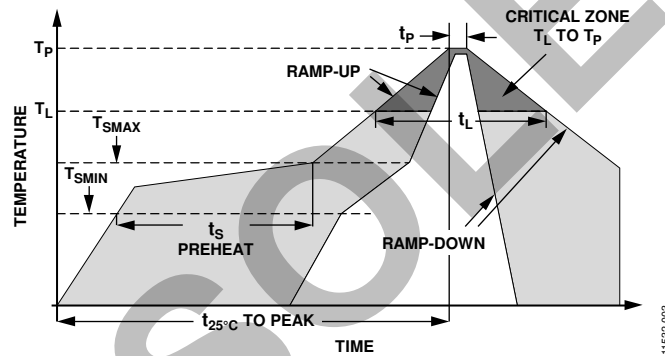
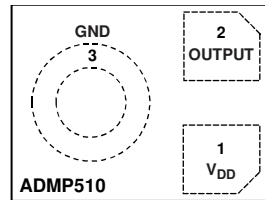

Figure 3. Recommended Soldering Profile Limits

Table 3. Recommended Soldering Profile Limits

Profile Feature	Sn63/Pb37	Pb-Free
Average Ramp Rate (T_L to T_P)	1.25°C/sec maximum	1.25°C/sec maximum
Preheat		
Minimum Temperature (T_{SMIN})	100°C	150°C
Maximum Temperature (T_{SMAX})	150°C	200°C
Time, T_{SMIN} to T_{SMAX} (t_S)	60 sec to 75 sec	60 sec to 75 sec
Ramp-Up Rate (T_{SMAX} to T_L)	1.25°C/sec	1.25°C/sec
Time Maintained Above Liquidous (t_L)	45 sec to 75 sec	~50 sec
Liquidous Temperature (T_L)	183°C	217°C
Peak Temperature (T_P)	215°C +3°C/-3°C	260°C +0°C/-5°C
Time Within 5°C of Actual Peak Temperature (t_P)	20 sec to 30 sec	20 sec to 30 sec
Ramp-Down Rate	3°C/sec maximum	3°C/sec maximum
Time 25°C ($t_{25^\circ C}$) to Peak Temperature	5 minutes maximum	5 minutes maximum

PIN CONFIGURATION AND FUNCTION DESCRIPTIONS



TOP VIEW
(TERMINAL SIDE DOWN)
Not to Scale

11552-004

Figure 4. Pin Configuration

Table 4. Pin Function Descriptions

Pin No.	Mnemonic	Description
1	V _{DD}	Power Supply
2	OUTPUT	Analog Output Signal
3	GND	Ground

TYPICAL PERFORMANCE CHARACTERISTICS

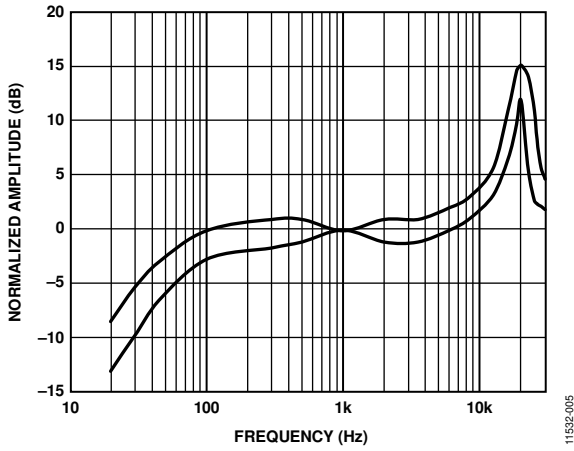

Figure 5. Frequency Response Mask

11532-005

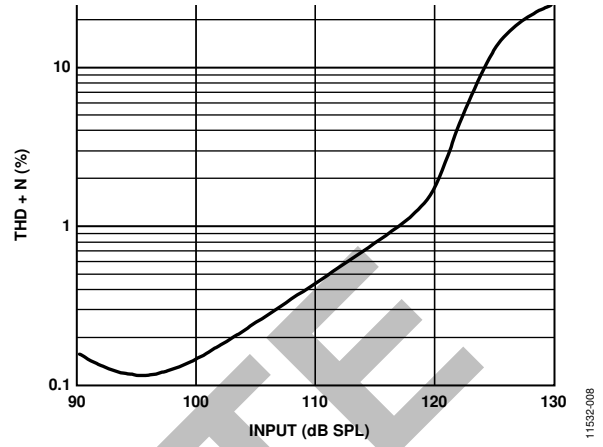

Figure 8. THD + N vs. Input SPL

11532-008

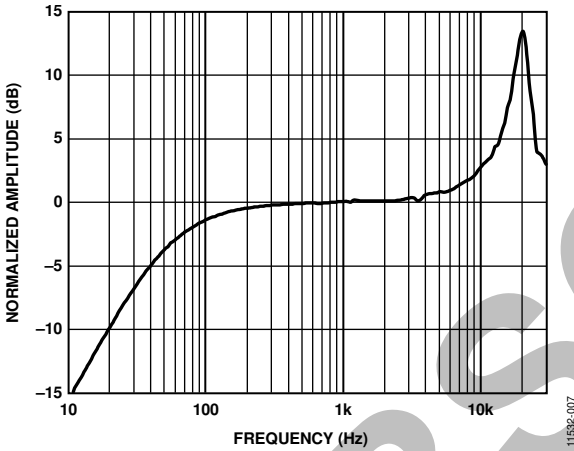

Figure 6. Typical Frequency Response (Measured)

11532-007

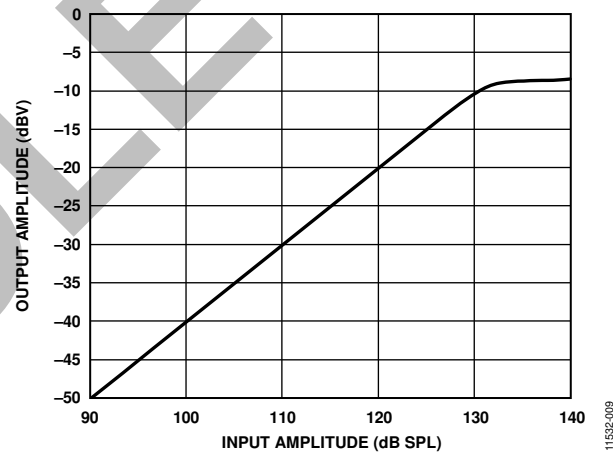

Figure 9. Linearity

11532-009

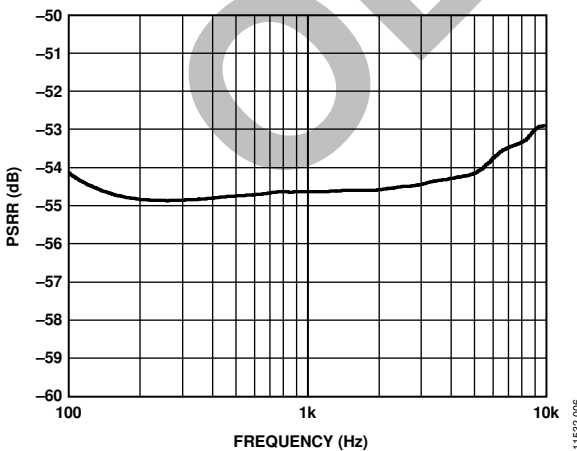

Figure 7. Typical Power Supply Rejection Ratio vs. Frequency

11532-006

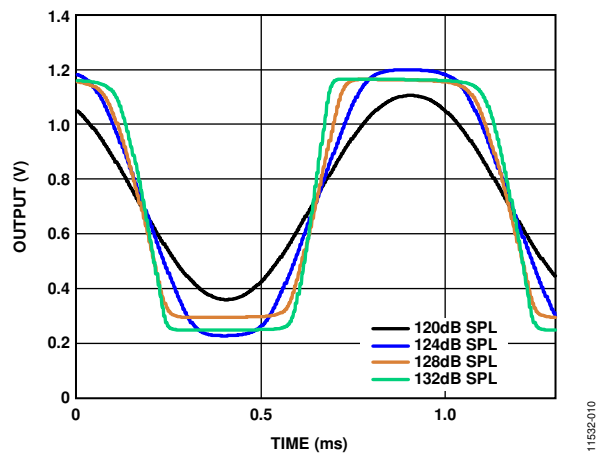

Figure 10. Clipping Characteristics

11532-010

APPLICATIONS INFORMATION

INTERFACING WITH ANALOG DEVICES CODECS

The output of the [ADMP510](#) can be connected to a dedicated codec microphone input (see Figure 11) or to a high input impedance gain stage (see Figure 12). A 0.1 μF ceramic capacitor placed close to the [ADMP510](#) supply pin is used for testing and is recommended to adequately decouple the microphone from noise on the power supply. A dc blocking capacitor is required at the output of the microphone. This capacitor creates a high-pass filter with a corner frequency at

$$f_c = 1/(2\pi \times C \times R)$$

where R is the input impedance of the codec.

A minimum value of 2.2 μF is recommended in Figure 11 because the input impedance of the [ADAU1761/ADAU1361](#) can be as low as 2 k Ω at its highest PGA gain setting, which results in a high-pass filter corner frequency at about 37 Hz.

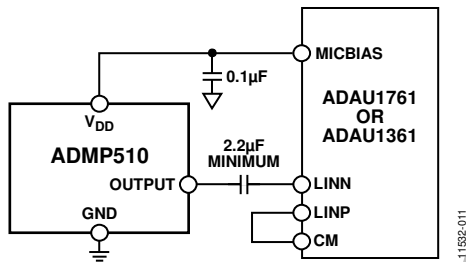

Figure 11. [ADMP510](#) Connected to the [ADAU1761](#) or [ADAU1361](#) Codec

Figure 12 shows the [ADMP510](#) connected to an [ADA4075-2](#) op amp configured as a noninverting preamplifier.

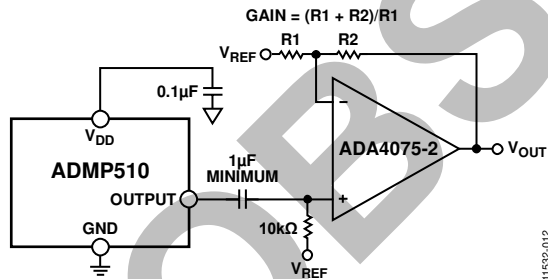

Figure 12. [ADMP510](#) Connected to the [ADA4075-2](#) Op Amp

SUPPORTING DOCUMENTS

For additional information, see the following documents.

Evaluation Board User Guide

[UG-325](#), *Analog Output MEMS Microphone Flex Evaluation Board*

Circuit Note

[CN-0207](#), *High Performance Analog MEMS Microphone's Simple Interface to SigmaDSP Audio Codec*

Application Notes

[AN-1003](#), *Recommendations for Mounting and Connecting the Analog Devices, Inc., Bottom-Ported MEMS Microphones*

[AN-1068](#), *Reflow Soldering of the MEMS Microphone*

[AN-1112](#), *Microphone Specifications Explained*

[AN-1124](#), *Recommendations for Sealing Analog Devices, Inc., Bottom-Port MEMS Microphones from Dust and Liquid Ingress*

[AN-1140](#), *Microphone Array Beamforming*

[AN-1165](#), *Op Amps for MEMS Microphone Preamp Circuits*

[AN-1181](#), *Using a MEMS Microphone in a 2-Wire Microphone Circuit*

PCB DESIGN AND LAND PATTERN LAYOUT

Lay out the PCB land pattern for the [ADMP510](#) at a 1:1 ratio to the solder pads on the microphone package (see Figure 13). Take care to avoid applying solder paste to the sound hole in the PCB. Figure 14 shows a suggested solder paste stencil pattern layout.

The diameter of the sound hole in the PCB should be larger than the diameter of the sound port of the microphone. A minimum diameter of 0.5 mm is recommended.

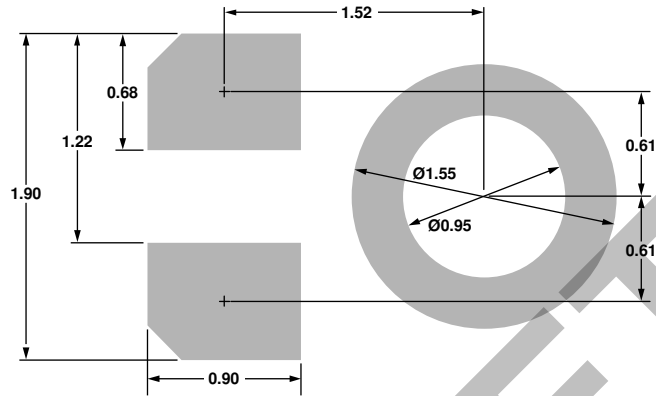

Figure 13. Suggested PCB Land Pattern Layout

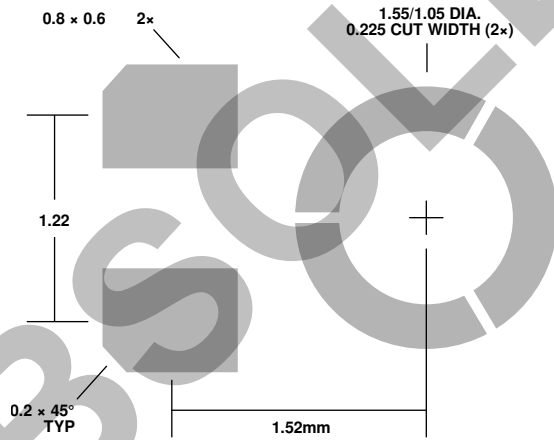

Figure 14. Suggested Solder Paste Stencil Pattern Layout

HANDLING INSTRUCTIONS

PICK-AND-PLACE EQUIPMENT

The MEMS microphone can be handled using standard pick-and-place and chip shooting equipment. Take care to avoid damage to the MEMS microphone structure as follows:

- Use a standard pickup tool to handle the microphone. Because the microphone hole is located on the bottom surface of the package (see Figure 2), the pickup tool can make contact with any part of the top lid surface.
- Do not pick up the microphone with a vacuum tool that makes contact with the bottom side of the microphone.
- Do not use excessive force to place the microphone on the PCB.

REFLOW SOLDER

For best results, the soldering profile should be in accordance with the recommendations of the manufacturer of the solder paste used to attach the MEMS microphone to the PCB. It is recommended that the solder reflow profile not exceed the limit conditions specified in Figure 3 and Table 3.

BOARD WASH

When washing the PCB, ensure that water does not make contact with the microphone port. Do not use blow-off procedures or ultrasonic cleaning.

OBSOLETE

OUTLINE DIMENSIONS

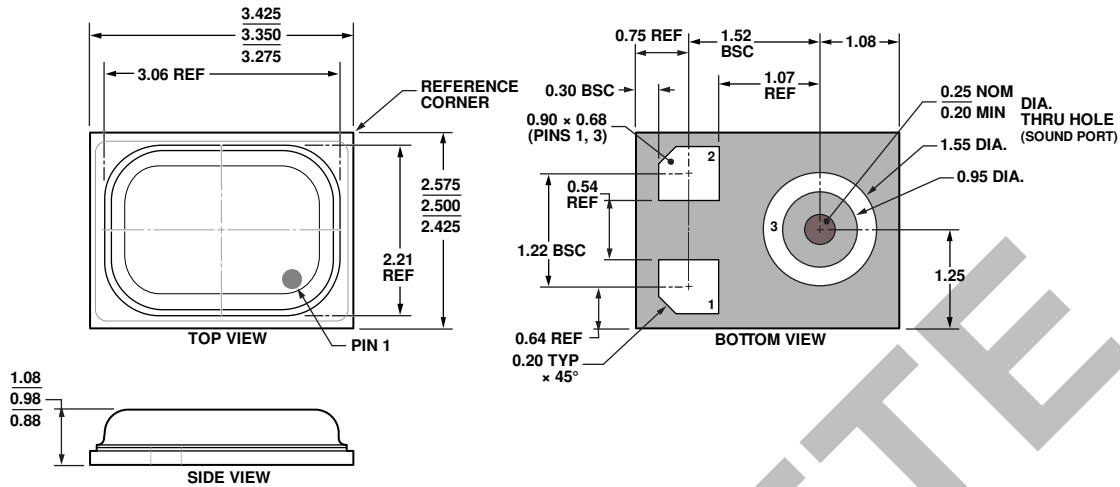

Figure 15. 3-Terminal Chip Array Small Outline No Lead Cavity [LGA_CAV]
 3.35 mm x 2.5 mm Body
 (CE-3-5)
 Dimensions shown in millimeters

01-29-2013-A

ORDERING GUIDE

Model ¹	Temperature Range	Package Description	Package Option ²	Ordering Quantity
ADMP510ACEZ-RL	-40°C to +85°C	3-Terminal LGA_CAV, 13" Tape and Reel	CE-3-5	10,000
ADMP510ACEZ-RL7	-40°C to +85°C	3-Terminal LGA_CAV, 7" Tape and Reel	CE-3-5	1,000
EVAL-ADMP510Z-FLEX		Flexible Evaluation Board		

¹ Z = RoHS Compliant Part.
² This package option is halide free.

NOTES

OBSOLETE

NOTES

OBSOLETE