

**AEC-Q200 Compliant Chip Multilayer Ceramic Capacitors for Infotainment**  
**GRT21BC71E106KE13\_ (0805, X7S:EIA, 10uF, DC25V)**  
 \_: packaging code

**Reference Sheet**

**1.Scope**

This product specification is applied to Chip Multilayer Ceramic Capacitors used for Car Multimedia, Car Interior, Car Comfort application and General Electronic equipment.

Please contact us when using this product for any other applications than described in the above.

Do not use these products in applications critical to passenger safety and car driving function (e.g. ABS, AIRBAG, etc.).

**2.MURATA Part NO. System**

(Ex.)

GRT	21	B	C7	1E	106	K	E13	L
	(1)L/W Dimensions	(2)T Dimensions	(3)Temperature Characteristics	(4)Rated Voltage	(5)Nominal Capacitance	(6)Capacitance Tolerance	(7)Murata's Control Code	(8)Packaging Code

**3. Type & Dimensions**

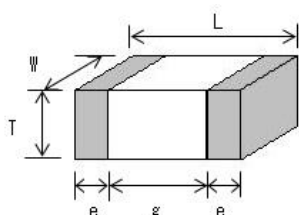

(Unit:mm)

(1)-1 L	(1)-2 W	(2) T	e	g
2.0±0.2	1.25±0.2	1.25±0.2	0.2 to 0.7	0.7 min.

**4.Rated value**

(3) Temperature Characteristics (Public STD Code):X7S(EIA)		(4) Rated Voltage	(5) Nominal Capacitance	(6) Capacitance Tolerance	Specifications and Test Methods (Operating Temp. Range)
Temp. coeff or Cap. Change	Temp. Range (Ref.Temp.)				
-22 to 22 %	-55 to 125 °C (25 °C)	DC 25 V	10 uF	±10 %	-55 to 125 °C

**5.Package**

mark	(8) Packaging	Packaging Unit
L	φ180mm Reel EMBOSED W8P4	3000 pcs./Reel
K	φ330mm Reel EMBOSED W8P4	10000 pcs./Reel

Product specifications in this catalog are as of Sep.9,2021,and are subject to change or obsolescence without notice.  
 Please consult the approval sheet before ordering.  
 Please read rating and !Cautions first.

■ AEC-Q200 Murata Standard Specification and Test Methods

No	AEC-Q200 Test Item	Specifications.	AEC-Q200 Test Method																						
1	Pre-and Post-Stress Electrical Test		-																						
2	High Temperature Exposure (Storage)	The measured and observed characteristics should satisfy the specifications in the following table.	Solder the capacitor on the test substrate(glass epoxy board). Set the capacitor for 1000+/-12 hours at maximum operating temperature +/-3°C. Set for 24+/-2 hours at room temperature, then measure.  • Initial measurement Perform a heat treatment at 150+0/-10 °C for 1hour and then sit for 24+/-2 hours at room temperature. Perform the initial measurement.																						
	Appearance	No marking defects																							
	Capacitance Change	Within +/-12.5%																							
	D.F.	0.2 max.																							
3	Temperature Cycling	The measured and observed characteristics should satisfy the specifications in the following table.	Solder the capacitor on the test substrate(glass epoxy board). Perform cycles test according to the four heat treatments in the following table. Set for 24+/-2 hours at room temperature, then measure.  <table border="1" style="margin-left: 20px;"> <thead> <tr> <th rowspan="2">Step</th> <th rowspan="2">Time (min)</th> <th colspan="2">Cycles</th> </tr> <tr> <th>1000</th> <th>5</th> </tr> </thead> <tbody> <tr> <td>1</td> <td>15+/-3</td> <td>-40°C+0/-3</td> <td>-55°C+0/-3</td> </tr> <tr> <td>2</td> <td>1</td> <td>Room</td> <td>Room</td> </tr> <tr> <td>3</td> <td>15+/-3</td> <td>105°C+3/-0</td> <td>125°C+3/-0</td> </tr> <tr> <td>4</td> <td>1</td> <td>Room</td> <td>Room</td> </tr> </tbody> </table> • Initial measurement Perform a heat treatment at 150+0/-10 °C for 1hour and then sit for 24+/-2 hours at room temperature. Perform the initial measurement.	Step	Time (min)	Cycles		1000	5	1	15+/-3	-40°C+0/-3	-55°C+0/-3	2	1	Room	Room	3	15+/-3	105°C+3/-0	125°C+3/-0	4	1	Room	Room
	Step	Time (min)				Cycles																			
				1000	5																				
	1	15+/-3		-40°C+0/-3	-55°C+0/-3																				
2	1	Room	Room																						
3	15+/-3	105°C+3/-0	125°C+3/-0																						
4	1	Room	Room																						
Appearance	No marking defects																								
Capacitance Change	Within +/-7.5%																								
D.F.	0.2 max.																								
4	Destructive Physical Analysis	No defects or abnormalities	Per EIA-469																						
	5	Biased Humidity	The measured and observed characteristics should satisfy the specifications in the following table.	Solder the capacitor on the test substrate(glass epoxy board). Apply the rated voltage and 1.3+0.2/-0Vdc (add 6.8kΩ resistor) at 85+/-3°C and 80%RH to 85%RH humidity for 1000+/-12 hours. The charge/discharge current is less than 50mA.  • Initial measurement Perform a heat treatment at 150+0/-10 °C for 1hour and then sit for 24+/-2 hours at room temperature. Perform the initial measurement.  • Measurement after test Perform a heat treatment at 150+0/-10 °C for 1hour and then sit for 24+/-2 hours at room temperature. Perform the initial measurement.																					
		Appearance	No marking defects																						
		Capacitance Change	Within +/-12.5%																						
D.F.		0.2 max.																							
5	Biased Humidity	Insulation Resistance 25°C	More than 100MΩ or 5Ω · F (Whichever is smaller)																						

No	AEC-Q200 Test Item	Specifications.	AEC-Q200 Test Method									
6	Operational Life	The measured and observed characteristics should satisfy the specifications in the following table.	Solder the capacitor on the test substrate(glass epoxy board). Apply 100% of the rated voltage for 1000+/-12 hours at maximum operating temperature +/-3°C. The charge/discharge current is less than 50mA.  • Initial measurement Perform a heat treatment at 150+0/-10 °C for 1 hour and then sit for 24+/-2 hours at room temperature. Perform the initial measurement.  • Measurement after test Perform a heat treatment at 150+0/-10 °C for 1 hour and then sit for 24+/-2 hours at room temperature. Perform the initial measurement.									
	Appearance	No marking defects										
	Capacitance Change	Within +/-12.5%										
	D.F.	0.2 max.										
7	External Visual	No defects or abnormalities	Visual inspection									
				8	Physical Dimension	Within the specified dimensions	Using Measuring instrument of dimension.					
								9	Resistance to Solvents	Appearance	No marking defects	Per MIL-STD-202 Method 215 Solvent 1 : 1 part (by volume) of isopropyl alcohol 3 parts (by volume) of mineral spirits Solvent 2 : Terpene defluxer Solvent 3 : 42 parts (by volume) of water 1 part (by volume) of propylene glycol monomethyl ether 1 part (by volume) of monoethanolamine
										Capacitance	Within the specified initial value.	
D.F.	Within the specified initial value.											
Insulation Resistance 25°C	Within the specified initial value.											
10	Mechanical Shock	Appearance	No marking defects	Solder the capacitor on the test substrate(glass epoxy board). Three shocks in each direction should be applied along 3 mutually perpendicular axes of the test specimen (18 shocks). The specified test pulse should be Half-sine and should have a duration :0.5ms, peak value:1500g and velocity change: 4.7m/s.								
		Capacitance	Within the specified initial value.									
		D.F.	Within the specified initial value.									
		Insulation Resistance 25°C	Within the specified initial value.									
11	Vibration	Appearance	No marking defects	Solder the capacitor on the test substrate(glass epoxy board). The capacitor should be subjected to a simple harmonic motion having a total amplitude of 1.5mm, the frequency being varied uniformly between the approximate limits of 10Hz and 2000Hz. The frequency range, from 10Hz to 2000Hz and return to 10Hz, should be traversed in approximately 20 minutes. This motion should be applied for 12 cycles in each 3 mutually perpendicular directions (total of 36 times).								
		Capacitance	Within the specified initial value.									
		D.F.	Within the specified initial value.									
		Insulation Resistance 25°C	Within the specified initial value.									
12	Resistance to Soldering Heat	The measured and observed characteristics should satisfy the specifications in the following table.	Immerse the capacitor in Sn-3.0Ag-0.5Cu solder solution or an eutectic solder solution at 260+/-5°C for 10+/-1 seconds. Set for 24+/-2 hours at room temperature, then measure.  • Initial measurement Perform a heat treatment at 150+0/-10 °C for 1 hour and then sit for 24+/-2 hours at room temperature. Perform the initial measurement.									
		Appearance		No marking defects								
		Capacitance Change		Within +/-15%								
		D.F.		Within the specified initial value.								
12	Resistance to Soldering Heat	Insulation Resistance 25°C	Within the specified initial value.									

No	AEC-Q200 Test Item	Specifications.	AEC-Q200 Test Method														
13	Thermal Shock	The measured and observed characteristics shall satisfy the specifications in the following table.	Solder the capacitor on the test substrate(glass epoxy board). Perform the 300 cycles according to the two heat treatments listed in the following table(Maximum transfer time is 20 seconds). Set for 24+/-2 hours at room temperature, then measure. <table border="1" style="margin: 10px auto;"> <thead> <tr> <th>Step</th> <th>1</th> <th>2</th> </tr> </thead> <tbody> <tr> <td>Temp.(°C)</td> <td>Min.Operating Temp.+0/-3</td> <td>Max.Operating Temp.+3/-0</td> </tr> <tr> <td>Time (min)</td> <td>15+/-3</td> <td>15+/-3</td> </tr> </tbody> </table> • Initial measurement Perform a heat treatment at 150+0/-10 °C for 1hour and then sit for 24+/-2 hours at room temperature. Perform the initial measurement.	Step	1	2	Temp.(°C)	Min.Operating Temp.+0/-3	Max.Operating Temp.+3/-0	Time (min)	15+/-3	15+/-3					
	Step	1		2													
	Temp.(°C)	Min.Operating Temp.+0/-3		Max.Operating Temp.+3/-0													
	Time (min)	15+/-3		15+/-3													
Appearance	No marking defects																
Capacitance Change	Within +/-10.0%																
14	ESD	Appearance	Per AEC-Q200-002 Voltage setting level : 2kV														
		Capacitance		Within the specified initial value.													
		D.F.		Within the specified initial value.													
		Insulation Resistance 25°C		Within the specified initial value.													
15	Solderability	95% of the terminations is to be soldered evenly and continuously.	(a) Preheat at 155°C for 4 hours. After preheating, immerse the capacitor in a solution of rosin ethanol 25(mass)%. Immerse in Sn-3.0Ag-0.5Cu solder solution at 245+/-5°C or an eutectic solder solution at 235+/-5°C for 5+0/-0.5 seconds.														
			(b) should be placed into steam aging for 8 hours+/-15 minutes. After preheating, immerse the capacitor in a solution of rosin ethanol 25(mass)%. Immerse in Sn-3.0Ag-0.5Cu solder solution at 245+/-5°C or an eutectic solder solution at 235+/-5°C for 5+0/-0.5 seconds.														
			(c) should be placed into steam aging for 8 hours+/-15 minutes. After preheating, immerse the capacitor in a solution of rosin ethanol 25(mass)%. Immerse in Sn-3.0Ag-0.5Cu solder solution or an eutectic solder solution for 120+/-5 seconds at 260+/-5°C.														
16	Electrical Chatacterization	Appearance	Visual inspection.														
		Capacitance	The capacitance/D.F. should be measured at 25°C at the frequency and voltage shown in the table. <table border="1" style="margin: 10px auto;"> <thead> <tr> <th rowspan="2">Char Item.</th> <th colspan="2">C ≤ 10μF</th> <th rowspan="2">10μF &lt; C</th> </tr> <tr> <th>6.3V max.</th> <th>10V min.</th> </tr> </thead> <tbody> <tr> <td>Frequency</td> <td>1.0+/-0.1kHz</td> <td>1.0+/-0.1kHz</td> <td>120+/-24Hz</td> </tr> <tr> <td>Voltage</td> <td>0.5+/-0.1Vrms</td> <td>1.0+/-0.2Vrms</td> <td>0.5+/-0.1Vrms</td> </tr> </tbody> </table>	Char Item.	C ≤ 10μF		10μF < C	6.3V max.	10V min.	Frequency	1.0+/-0.1kHz	1.0+/-0.1kHz	120+/-24Hz	Voltage	0.5+/-0.1Vrms	1.0+/-0.2Vrms	0.5+/-0.1Vrms
		Char Item.			C ≤ 10μF			10μF < C									
			6.3V max.	10V min.													
		Frequency	1.0+/-0.1kHz	1.0+/-0.1kHz	120+/-24Hz												
		Voltage	0.5+/-0.1Vrms	1.0+/-0.2Vrms	0.5+/-0.1Vrms												
D.F.	0.125 max.																
Insulation Resistance 25°C	More than 1000MΩ or 50Ω · F (Whichever is smaller)	The insulation resistance should be measured with a DC voltage not exceeding the rated voltage at 25°C and maximum operating temperature within 1minute of charging.															
Insulation Resistance 125°C	More than 100MΩ or 5Ω · F (Whichever is smaller)	The charge/discharge current is less than 50mA.															
Dielectric Strength	No failure	No failure should be observed when 250% of the rated voltage is applied between the terminations for 1 second to 5 seconds. The charge/discharge current is less than 50mA.															

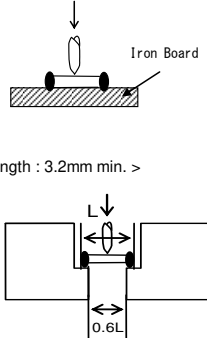
No	AEC-Q200 Test Item	Specifications.	AEC-Q200 Test Method																												
17	Board Flex	<p>Appearance: No marking defects</p> <p>Capacitance: Within the specified initial value.</p> <p>D.F.: Within the specified initial value.</p> <p>Insulation Resistance 25°C: Within the specified initial value.</p>	<p>Solder the capacitor on the test substrate(glass epoxy board) shown in Fig1.</p> <p>Then apply a force in the direction shown in Fig 2 for 60 seconds.</p> <p>The soldering should be done by the reflow method and should be conducted with care so that the soldering is uniform and free of defects such as heat shock.</p> <table border="1" data-bbox="938 472 1358 618"> <thead> <tr> <th>Series</th> <th>a</th> <th>b</th> <th>c</th> </tr> </thead> <tbody> <tr> <td>GRT03</td> <td>0.3</td> <td>0.9</td> <td>0.3</td> </tr> <tr> <td>GRT15</td> <td>0.5</td> <td>1.5</td> <td>0.6</td> </tr> <tr> <td>GRT18</td> <td>0.6</td> <td>2.2</td> <td>0.9</td> </tr> <tr> <td>GRT21</td> <td>0.8</td> <td>3.0</td> <td>1.3</td> </tr> <tr> <td>GRT31</td> <td>2.0</td> <td>4.4</td> <td>1.7</td> </tr> <tr> <td>GRT32</td> <td>2.0</td> <td>4.4</td> <td>2.6</td> </tr> </tbody> </table> <p>(in mm)</p>  <p>Fig.1 t : 1.6mm (GRT03,15:0.8mm)</p>  <p>Fig.2</p>	Series	a	b	c	GRT03	0.3	0.9	0.3	GRT15	0.5	1.5	0.6	GRT18	0.6	2.2	0.9	GRT21	0.8	3.0	1.3	GRT31	2.0	4.4	1.7	GRT32	2.0	4.4	2.6
Series	a	b	c																												
GRT03	0.3	0.9	0.3																												
GRT15	0.5	1.5	0.6																												
GRT18	0.6	2.2	0.9																												
GRT21	0.8	3.0	1.3																												
GRT31	2.0	4.4	1.7																												
GRT32	2.0	4.4	2.6																												
18	Terminal Strength	<p>Appearance: No marking defects</p> <p>Capacitance: Within the specified initial value.</p> <p>D.F.: Within the specified initial value.</p> <p>Insulation Resistance 25°C: Within the specified initial value.</p>	<p>Solder the capacitor on the test substrate(glass epoxy board) shown in Fig3.</p> <p>Then apply 18N* force in parallel with the test jig for 60 seconds.</p> <p>The soldering should be done either with an iron or using the reflow method and should be conducted with care so that the soldering is uniform and free of defects such as heat shock</p> <p>*2N(GRT03,15)</p> <table border="1" data-bbox="948 1115 1367 1261"> <thead> <tr> <th>Series</th> <th>a</th> <th>b</th> <th>c</th> </tr> </thead> <tbody> <tr> <td>GRT03</td> <td>0.3</td> <td>0.9</td> <td>0.3</td> </tr> <tr> <td>GRT15</td> <td>0.4</td> <td>1.5</td> <td>0.5</td> </tr> <tr> <td>GRT18</td> <td>1.0</td> <td>3.0</td> <td>1.2</td> </tr> <tr> <td>GRT21</td> <td>1.2</td> <td>4.0</td> <td>1.65</td> </tr> <tr> <td>GRT31</td> <td>2.2</td> <td>5.0</td> <td>2.0</td> </tr> <tr> <td>GRT32</td> <td>2.2</td> <td>5.0</td> <td>2.9</td> </tr> </tbody> </table> <p>(in mm)</p>  <p>Fig.3</p>	Series	a	b	c	GRT03	0.3	0.9	0.3	GRT15	0.4	1.5	0.5	GRT18	1.0	3.0	1.2	GRT21	1.2	4.0	1.65	GRT31	2.2	5.0	2.0	GRT32	2.2	5.0	2.9
Series	a	b	c																												
GRT03	0.3	0.9	0.3																												
GRT15	0.4	1.5	0.5																												
GRT18	1.0	3.0	1.2																												
GRT21	1.2	4.0	1.65																												
GRT31	2.2	5.0	2.0																												
GRT32	2.2	5.0	2.9																												
19	Beam Load Test	<p>Destruction value should be exceed following one.</p> <p>&lt; Chip L dimension : 2.5mm max. &gt;</p> <p>Chip thickness &gt; 0.5mm rank : 20N</p> <p>Chip thickness = 0.5mm rank : 8N</p> <p>Chip thickness = 0.3mm rank : 5N</p> <p>Chip thickness &lt; 0.3mm rank : 2.5N</p> <p>&lt; Chip L dimension : 3.2mm min. &gt;</p> <p>Chip thickness &lt; 1.25mm rank : 15N</p> <p>Chip thickness ≥ 1.25mm rank : 54.5N</p>	<p>Place the capacitor in the beam load fixture as Fig 4.</p> <p>Apply a force.</p> <p>&lt; Chip Length : 2.5mm max. &gt;</p>  <p>Fig.4</p> <p>Speed supplied the Stress Load : *0.5mm/s *GRT03 : 0.1mm/s</p>																												

No	AEC-Q200 Test Item	Specifications.	AEC-Q200 Test Method												
20	Capacitance Temperature Characteristics	C7 : Within +/-22% (-55°C to +125°C) D7 : Within +22/-33% (-55°C to +125°C) E7 : Within +22/-56% (-55°C to +125°C)	The capacitance change should be measured after 5 minutes at each specified temperature stage. Capacitance value as a reference is the value in step 3.  · Measurement Voltage : Less than 1.0Vrms (Refer to the individual data sheet) <table border="1" style="margin: 10px auto;"> <thead> <tr> <th>Step</th> <th>Temperature(°C)</th> </tr> </thead> <tbody> <tr> <td>1</td> <td>Reference Temp.+/-2</td> </tr> <tr> <td>2</td> <td>Min. Operating Temp.+/-3</td> </tr> <tr> <td>3</td> <td>Reference Temp.+/-2</td> </tr> <tr> <td>4</td> <td>Max. Operating Temp.+/-3</td> </tr> <tr> <td>5</td> <td>Reference Temp.+/-2</td> </tr> </tbody> </table> · Initial measurement Perform a heat treatment at 150+0/-10 °C for 1 hour and then sit for 24+/-2 hours at room temperature. Perform the initial measurement.	Step	Temperature(°C)	1	Reference Temp.+/-2	2	Min. Operating Temp.+/-3	3	Reference Temp.+/-2	4	Max. Operating Temp.+/-3	5	Reference Temp.+/-2
Step	Temperature(°C)														
1	Reference Temp.+/-2														
2	Min. Operating Temp.+/-3														
3	Reference Temp.+/-2														
4	Max. Operating Temp.+/-3														
5	Reference Temp.+/-2														

Derating conditions on voltage and temperature (For Rated Voltage 100Vdc max.)

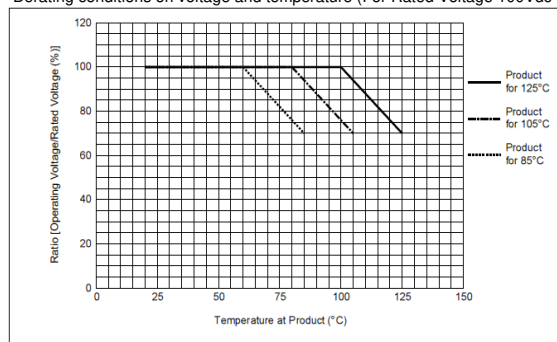

Derated products\*1 are suitable for use in circuits where continuous applied voltage and temperature to the capacitor is derated (below rated voltage and temperature).  
 A reliability assurance level equivalent to standard products\*2 can be secured by restricting the voltage and temperature according to the derating conditions in the chart.

\*1 Derated Products: The test voltage of these products is less than 150% of the rated voltage in the Durability / Operational Life Test.

\*2 Standard Products: The test voltage of these products is 150% of the rated voltage and over in the Durability / Operational Life Test.

1. Tape Carrier Packaging(Packaging Code:D/E/W/F/L/J/K)

1.1 Minimum Quantity(pcs./reel)

Type	φ180mm reel			φ330mm reel	
	Paper Tape		Plastic Tape	Paper Tape	Plastic Tape
	Code:D/E	Code:W	Code:L	Code:J/F	Code:K
GRT03	15000(W8P2)	30000(W8P1)		50000(W8P2)	
GRT15	2	20000(W8P2)		50000(W8P2)	
	3(LW Dimensions Tolerance:±0.05 and T Dimensions Tolerance:±0.03)	10000(W8P2)		50000(W8P2)	
	5(LWTDimensions Tolerance:±0.05)	10000(W8P2)	20000(W8P1)	50000(W8P2)	
	5(LWTDimensions Tolerance:±0.1min.)	10000(W8P2)		40000(W8P2)	
GRT18		4000		10000	
GRT21	6	4000		10000	
	9	4000		10000	
	B		3000		10000
GRT31	6	4000		10000	
	9	4000		10000	
	M		3000		10000
	C			2000	
GRT32	N				8000
	D/E				4000

1.2 Dimensions of Tape

(1)GRT03/15(Paper Tape W8P2 Code:D/E/J/F)

(in mm)



Type	Dimensions Tolerance(Chip)			A *3	B *3	t	
	L	W	T				
GRT03	3	0.6±0.03	0.3±0.03	0.3±0.03	0.37	0.67	0.5 max.
		0.6±0.05	0.3±0.05	0.3±0.05	0.39	0.69	
		0.6±0.09	0.3±0.09	0.3±0.09	0.44	0.74	
GRT15	2	1.0±0.05	0.5±0.05	0.2 +0.02/-0.04	0.65	1.15	0.8 max.
				0.3±0.03			
				0.5±0.05			
	5	1.0±0.1	0.5±0.1	0.5±0.1	0.70	1.20	
		1.0±0.15	0.5±0.15	0.5±0.15	0.72	1.25	
		1.0±0.2	0.5±0.2	0.5±0.2	0.78	1.29	

\*3 Nominal value

(2)GRT03/15Paper Tape W8P1 Code:W

(in mm)



Type		Dimensions Tolerance(Chip)			A	B	t
		L	W	T			
GRT03	3	0.6±0.03	0.3±0.03	0.3±0.03	0.37	0.67	0.5 max.
		0.6±0.05	0.3±0.05	0.3±0.05	0.39	0.69	
		0.6±0.09	0.3±0.09	0.3±0.09	0.44	0.74	0.6 max.
GRT15	5	1.0±0.05	0.5±0.05	0.5±0.05	0.65	1.15	0.8 max.

\*3 Nominal value

(3)GRT18/21/31/32(Paper Tape)

(in mm)



Type		Dimensions Tolerance(Chip)			A	B	t
		L	W	T			
GRT18	8	1.6±0.1	0.8±0.1	0.8±0.1	1.05±0.10	1.85±0.10	1.1 max.
		1.6±0.15	0.8±0.15	0.8±0.15			
		1.6±0.2	0.8±0.2	0.8±0.2			
GRT21	6	2.0±0.1	1.25±0.1	0.6±0.1	1.55±0.15	2.30±0.15	
				0.6+0/-0.15			
				0.85±0.1			
GRT31	9	2.0±0.15	1.25±0.15	0.85+0/-0.2	2.00±0.20	3.60±0.20	
				0.85±0.1			
				0.85±0.1			



(4)GRT21/31/32(Plastic Tape)

(in mm)



Type		Dimensions Tolerance(Chip)			A	B	t
		L	W	T			
GRT21	B	2.0±0.1	1.25±0.1	1.25±0.1	1.45±0.20	2.25±0.20	1.7 max.
		2.0±0.15	1.25±0.15	1.25±0.15	1.50±0.20	2.30±0.20	2.0 max.
		2.0±0.2	1.25±0.2	1.25±0.2			
GRT31	M	3.2±0.15	1.6±0.15	1.15±0.1	1.90±0.20	3.50±0.20	1.7 max.
		3.2±0.2	1.6±0.2	1.15±0.15			
	C	3.2±0.3	1.6±0.3	1.6±0.2	2.10±0.20	3.60±0.20	2.5 max.
GRT32	N	3.2±0.3	2.5±0.2	1.35±0.15	2.80±0.20	3.50±0.20	2.5 max.
	D			2.0±0.2			3.0 max.
	E			2.5±0.2			3.7 max.

Fig.1 Package Chips

(in mm)



Fig.2 Dimensions of Reel



Fig.3 Taping Diagram

	W	w <sub>1</sub>
GRT32 max.	16.5 max.	10±1.5



1.3 Tapes for capacitors are wound clockwise shown in Fig.3.  
(The sprocket holes are to the right as the tape is pulled toward the user.)

1.4 Part of the leader and part of the vacant section are attached as follows.



1.5 Accumulate tolerance of sprocket holes pitch =  $\pm 0.3\text{mm} / 10$  pitch

1.6 Chip in the tape is enclosed by top tape and bottom tape as shown in Fig.1.

1.7 The top tape and base tape are not attached at the end of the tape for a minimum of 5 pitches.

1.8 There are no jointing for top tape and bottom tape.

1.9 There are no fuzz in the cavity.

1.10 Break down force of top tape : 5N min.

Break down force of bottom tape : 5N min. (Only a bottom tape existence )

1.11 Reel is made by resin and appeaser and dimension is shown in Fig 1. There are possibly to change the material and dimension due to some impairment.

1.12 Peeling off force : 0.1N to 0.6N\* in the direction as shown below.

\* GRT03:0.05N to 0.5N



1.13 Label that show the customer parts number, our parts number, our company name, inspection number and quantity, will be put in outside of reel.

## ■ Limitation of Applications

Please contact us before using our products for the applications listed below which require especially high reliability for the prevention of defects which might directly cause damage to the third party's life, body or property.

- ① Aircraft equipment    ② Aerospace equipment    ③ Undersea equipment    ④ Power plant control equipment
- ⑤ Medical equipment    ⑥ Transportation equipment(vehicles, trains, ships, etc.)    ⑦ Traffic signal equipment
- ⑧ Disaster prevention / crime prevention equipment    ⑨ Data-processing equipment
- ⑩ Application of similar complexity and/or reliability requirements to the applications listed in the above.

This series is designed for use in Car Multimedia, Car Interior, Car Comfort application and General Electronic equipment. It is not appropriate for use in applications critical to passenger safety and car driving function(e.g. ABS, AIRBAG, etc.). Please use the GCM series in critical applications.

## ■ Storage and Operation condition

1. The performance of chip multilayer ceramic capacitors (henceforth just "capacitors") may be affected by the storage conditions. Please use them promptly after delivery.
  - 1-1. Maintain appropriate storage for the capacitors using the following conditions:  
Room Temperature of +5°C to +40°C and a Relative Humidity of 20% to 70%.  
  
High temperature and humidity conditions and/or prolonged storage may cause deterioration of the packaging materials. If more than six months have elapsed since delivery, check packaging, mounting, etc. before use. In addition, this may cause oxidation of the electrodes. If more than one year has elapsed since delivery, also check the solderability before use.
  - 1-2. Corrosive gas can react with the termination (external) electrodes or lead wires of capacitors, and result in poor solderability. Do not store the capacitors in an atmosphere consisting of corrosive gas (e.g., hydrogen sulfide, sulfur dioxide, chlorine, ammonia gas etc.).
  - 1-3. Due to moisture condensation caused by rapid humidity changes, or the photochemical change caused by direct sunlight on the terminal electrodes, the solderability and electrical performance may deteriorate. Do not store capacitors under direct sunlight or in high humidity conditions.

## ■ Rating

### 1. Temperature Dependent Characteristics

1. The electrical characteristics of the capacitor can change with temperature.
  - 1-1. For capacitors having larger temperature dependency, the capacitance may change with temperature changes. The following actions are recommended in order to ensure suitable capacitance values.
    - (1) Select a suitable capacitance for the operating temperature range.
    - (2) The capacitance may change within the rated temperature.  
When you use a high dielectric constant type capacitor in a circuit that needs a tight (narrow) capacitance tolerance (e.g., a time-constant circuit), please carefully consider the temperature characteristics, and carefully confirm the various characteristics in actual use conditions and the actual system.

[Example of Temperature Characteristics X7R(R7)]  
Sample: 0.1μF, Rated Voltage 50VDC



[Example of Temperature Characteristics X5R(R6)]  
Sample: 22μF, Rated Voltage 4VDC



## 2.Measurement of Capacitance

1. Measure capacitance with the voltage and frequency specified in the product specifications.
  - 1-1. The output voltage of the measuring equipment may decrease occasionally when capacitance is high. Please confirm whether a prescribed measured voltage is impressed to the capacitor.
  - 1-2. The capacitance values of high dielectric constant type capacitors change depending on the AC voltage applied. Please consider the AC voltage characteristics when selecting a capacitor to be used in a AC circuit.

## 3.Applied Voltage

1. Do not apply a voltage to the capacitor that exceeds the rated voltage as called out in the specifications.
  - 1-1. Applied voltage between the terminals of a capacitor shall be less than or equal to the rated voltage.
    - (1) When AC voltage is superimposed on DC voltage, the zero-to-peak voltage shall not exceed the rated DC voltage. When AC voltage or pulse voltage is applied, the peak-to-peak voltage shall not exceed the rated DC voltage.
    - (2) Abnormal voltages (surge voltage, static electricity, pulse voltage, etc.) shall not exceed the rated DC voltage.

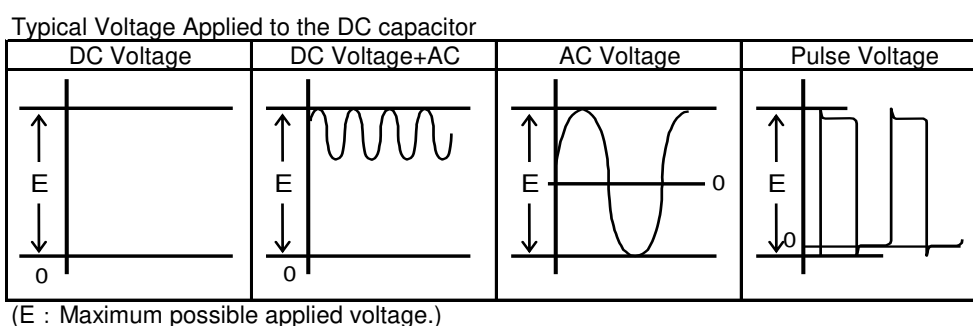

- 1-2. Influence of over voltage
 

Over voltage that is applied to the capacitor may result in an electrical short circuit caused by the breakdown of the internal dielectric layers .

The time duration until breakdown depends on the applied voltage and the ambient temperature.

## 4.Type of Applied Voltage and Self-heating Temperature

1. Confirm the operating conditions to make sure that no large current is flowing into the capacitor due to the continuous application of an AC voltage or pulse voltage.
 

When a DC rated voltage product is used in an AC voltage circuit or a pulse voltage circuit, the AC current or pulse current will flow into the capacitor; therefore check the self-heating condition.

Please confirm the surface temperature of the capacitor so that the temperature remains within the upper limits of the operating temperature, including the rise in temperature due to self-heating. When the capacitor is used with a high-frequency voltage or pulse voltage, heat may be generated by dielectric loss.

<Applicable to Rated Voltage of less than 100VDC>  
 The load should be contained so that the self-heating of the capacitor body remains below 20°C , when measuring at an ambient temperature of 25°C.



### 5. DC Voltage and AC Voltage Characteristic

1. The capacitance value of a high dielectric constant type capacitor changes depending on the DC voltage applied. Please consider the DC voltage characteristics when a capacitor is selected for use in a DC circuit.

1-1. The capacitance of ceramic capacitors may change sharply depending on the applied voltage. (See figure) Please confirm the following in order to secure the capacitance.

- (1) Determine whether the capacitance change caused by the applied voltage is within the allowed range .
- (2) In the DC voltage characteristics, the rate of capacitance change becomes larger as voltage increases, even if the applied voltage is below the rated voltage. When a high dielectric constant type capacitor is used in a circuit that requires a tight (narrow) capacitance tolerance (e.g., a time constant circuit), please carefully consider the voltage characteristics, and confirm the various characteristics in the actual operating conditions of the system.

2. The capacitance values of high dielectric constant type capacitors changes depending on the AC voltage applied. Please consider the AC voltage characteristics when selecting a capacitor to be used in a AC circuit.

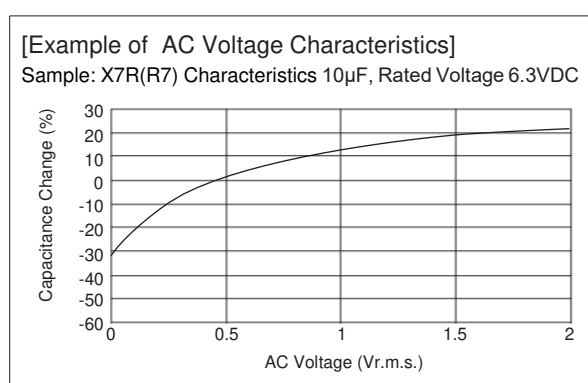
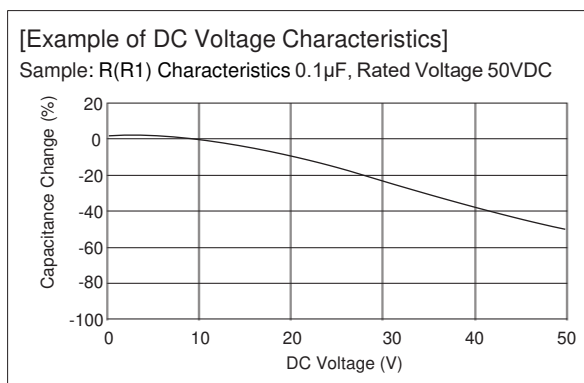

### 6. Capacitance Aging

1. The high dielectric constant type capacitors have an Aging characteristic in which the capacitance value decreases with the passage of time. When you use a high dielectric constant type capacitors in a circuit that needs a tight (narrow) capacitance tolerance (e.g., a time-constant circuit), please carefully consider the characteristics of these capacitors, such as their aging, voltage, and temperature characteristics. In addition, check capacitors using your actual appliances at the intended environment and operating conditions.

[ Example of Change Over Time (Aging characteristics) ]



### 7.Vibration and Shock

1. Please confirm the kind of vibration and/or shock, its condition, and any generation of resonance. Please mount the capacitor so as not to generate resonance, and do not allow any impact on the terminals.

2. Mechanical shock due to being dropped may cause damage or a crack in the dielectric material of the capacitor. Do not use a dropped capacitor because the quality and reliability may be deteriorated.

3. When printed circuit boards are piled up or handled, the corner of another printed circuit board should not be allowed to hit the capacitor in order to avoid a crack or other damage to the capacitor.



## Soldering and Mounting

### 1. Mounting Position

1. Confirm the best mounting position and direction that minimizes the stress imposed on the capacitor during flexing or bending the printed circuit board.

1-1. Choose a mounting position that minimizes the stress imposed on the chip during flexing or bending of the board.  
[Component Direction]



Locate chip horizontal to the direction in which stress acts.

[Chip Mounting Close to Board Separation Point]

It is effective to implement the following measures, to reduce stress in separating the board.

It is best to implement all of the following three measures; however, implement as many measures as possible to reduce stress.

Contents of Measures	Stress Level
(1) Turn the mounting direction of the component parallel to the board separation surface.	A > D *1
(2) Add slits in the board separation part.	A > B
(3) Keep the mounting position of the component away from the board separation surface.	A > C



\*1 A > D is valid when stress is added vertically to the perforation as with Hand Separation.  
If a Cutting Disc is used, stress will be diagonal to the PCB, therefore A > D is invalid.

[Mounting Capacitors Near Screw Holes]

When a capacitor is mounted near a screw hole, it may be affected by the board deflection that occurs during the tightening of the screw. Mount the capacitor in a position as far away from the screw holes as possible.



### 2. Information before Mounting

- Do not re-use capacitors that were removed from the equipment.
- Confirm capacitance characteristics under actual applied voltage.
- Confirm the mechanical stress under actual process and equipment use.
- Confirm the rated capacitance, rated voltage and other electrical characteristics before assembly.
- Prior to use, confirm the solderability of capacitors that were in long-term storage.
- Prior to measuring capacitance, carry out a heat treatment for capacitors that were in long-term storage.
- The use of Sn-Zn based solder will deteriorate the reliability of the MLCC.  
Please contact our sales representative or product engineers on the use of Sn-Zn based solder in advance.

**3.Maintenance of the Mounting (pick and place) Machine**

1. Make sure that the following excessive forces are not applied to the capacitors.  
 Check the mounting in the actual device under actual use conditions ahead of time.

1-1. In mounting the capacitors on the printed circuit board, any bending force against them shall be kept to a minimum to prevent them from any damage or cracking. Please take into account the following precautions and recommendations for use in your process.

(1) Adjust the lowest position of the pickup nozzle so as not to bend the printed circuit board.



2. Dirt particles and dust accumulated in the suction nozzle and suction mechanism prevent the nozzle from moving smoothly. This creates excessive force on the capacitor during mounting, causing cracked chips. Also, the locating claw, when worn out, imposes uneven forces on the chip when positioning, causing cracked chips. The suction nozzle and the locating claw must be maintained, checked and replaced periodically.



### 4-1.Reflow Soldering

- When sudden heat is applied to the components, the mechanical strength of the components will decrease because a sudden temperature change causes deformation inside the components. In order to prevent mechanical damage to the components, preheating is required for both the components and the PCB. Preheating conditions are shown in table 1. It is required to keep the temperature differential between the solder and the components surface ( $\Delta T$ ) as small as possible.
- When components are immersed in solvent after mounting, be sure to maintain the temperature difference ( $\Delta T$ ) between the component and the solvent within the range shown in the table 1.

[Standard Conditions for Reflow Soldering]



Temperature  
Inc case of Lead Free Solder  
( ): In case of Pb-Sn Solder

[Allowable Reflow Soldering Temperature and Time]



In the case of repeated soldering, the accumulated soldering time must be within the range shown above.

Table 1

Series	Chip Dimension(L/W) Code	Temperature Differential
GRT	03/15/18/21/31	$\Delta T \leq 190^{\circ}\text{C}$
GRT	32	$\Delta T \leq 130^{\circ}\text{C}$

Recommended Conditions

	Pb-Sn Solder	Lead Free Solder
Peak Temperature	230 to 250°C	240 to 260°C
Atmosphere	Air	Air or N <sub>2</sub>

Pb-Sn Solder: Sn-37Pb

Lead Free Solder: Sn-3.0Ag-0.5Cu

- When a capacitor is mounted at a temperature lower than the peak reflow temperature recommended by the solder manufacturer, the following quality problems can occur. Consider factors such as the placement of peripheral components and the reflow temperature setting to prevent the capacitor's reflow temperature from dropping below the peak temperature specified. Be sure to evaluate the mounting situation beforehand and verify that none of the following problems occur.
  - Drop in solder wettability
  - Solder voids
  - Possible occurrence of whiskering
  - Drop in bonding strength
  - Drop in self-alignment properties
  - Possible occurrence of tombstones and/or shifting on the land patterns of the circuit board

#### 4. Optimum Solder Amount for Reflow Soldering

- Overly thick application of solder paste results in a excessive solder fillet height. This makes the chip more susceptible to mechanical and thermal stress on the board and may cause the chips to crack.
- Too little solder paste results in a lack of adhesive strength on the termination, which may result in chips breaking loose from the PCB.
- Please confirm that solder has been applied smoothly to the termination.

#### Inverting the PCB

Make sure not to impose any abnormal mechanical shocks to the PCB.

**4-2.Flow Soldering**

1. Do not apply flow soldering to chips not listed in Table 2.

Table 2

Series	Chip Dimension (L/W) Code	Temperature Differential
GRT	18/21/31	$\Delta T \leq 150^{\circ}\text{C}$

2. When sudden heat is applied to the components, the mechanical strength of the components will decrease because a sudden temperature change causes deformation inside the components. In order to prevent mechanical damage to the components, preheating is required for both of the components and the PCB. Preheating conditions are shown in table 2. It is required to keep the temperature differential between the solder and the components surface ( $\Delta T$ ) as low as possible.

3. Excessively long soldering time or high soldering temperature can result in leaching of the terminations, causing poor adhesion or a reduction in capacitance value due to loss of contact between the inner electrodes and terminations.

4. When components are immersed in solvent after mounting, be sure to maintain the temperature differential ( $\Delta T$ ) between the component and solvent within the range shown in the table 2.

[Standard Conditions for Flow Soldering]



[Allowable Flow Soldering Temperature and Time]



In the case of repeated soldering, the accumulated soldering time must be within the range shown above.

**Recommended Conditions**

	Pb-Sn Solder	Lead Free Solder
Preheating Peak Temperature	90 to 110°C	100 to 120°C
Soldering Peak Temperature	240 to 250°C	250 to 260°C
Atmosphere	Air	Air or N2

Pb-Sn Solder: Sn-37Pb

Lead Free Solder: Sn-3.0Ag-0.5Cu

**5. Optimum Solder Amount for Flow Soldering**

5-1. The top of the solder fillet should be lower than the thickness of the components. If the solder amount is excessive, the risk of cracking is higher during board bending or any other stressful condition.



### 4-3. Correction of Soldered Portion

When sudden heat is applied to the capacitor, distortion caused by the large temperature difference occurs internally, and can be the cause of cracks. Capacitors also tend to be affected by mechanical and thermal stress depending on the board preheating temperature or the soldering fillet shape, and can be the cause of cracks. Please refer to "1. PCB Design" or "3. Optimum solder amount" for the solder amount and the fillet shapes.

#### 1. Correction with a Soldering Iron

- 1-1. In order to reduce damage to the capacitor, be sure to preheat the capacitor and the mounting board. Preheat to the temperature range shown in Table 3. A hot plate, hot air type preheater, etc. can be used for preheating.
- 1-2. After soldering, do not allow the component/PCB to cool down rapidly.
- 1-3. Perform the corrections with a soldering iron as quickly as possible. If the soldering iron is applied too long, there is a possibility of causing solder leaching on the terminal electrodes, which will cause deterioration of the adhesive strength and other problems.

Table 3

Series	Chip Dimension (L/W) Code	Temperature of Soldering Iron tip	Preheating Temperature	Temperature Differential(ΔT)	Atmosphere
GRT	03/15/18/21/31	350°C max.	150°C min.	$\Delta T \leq 190^\circ\text{C}$	Air
GRT	32	280°C max.	150°C min.	$\Delta T \leq 130^\circ\text{C}$	Air

\*Applicable for both Pb-Sn and Lead Free Sold Pb-Sn Solder: Sn-37Pb  
Lead Free Solder: Sn-3.0Ag-0.5Cu

\* Please manage Δ T in the temperature of soldering iron and the preheating temperature.

#### 2. Correction with Spot Heater

Compared to local heating with a soldering iron, hot air heating by a spot heater heats the overall component and board, therefore, it tends to lessen the thermal shock. In the case of a high density mounted board, a spot heater can also prevent concerns of the soldering iron making direct contact with the component.

- 2-1. If the distance from the hot air outlet of the spot heater to the component is too close, cracks may occur due to thermal shock. To prevent this problem, follow the conditions shown in Table 4.
- 2-2. In order to create an appropriate solder fillet shape, it is recommended that hot air be applied at the angle shown in Figure 1.

Table 4

Distance	5mm or more
Hot Air Application angle	45° *Figure 1
Hot Air Temperature Nozzle Outlet	400°C max.
Application Time	Less than 10s (Chip(L×W): 3.2×1.6mm or smaller)
	Less than 30s (Chip(L×W): 3.2×2.5mm or larger)

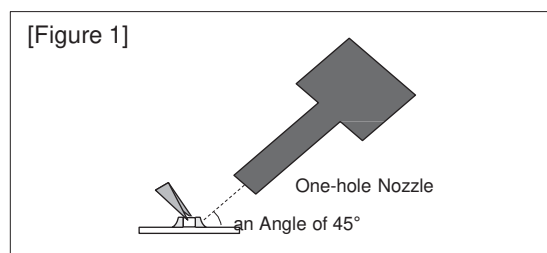

#### 3. Optimum solder amount when re-working with a soldering iron

- 3-1. If the solder amount is excessive, the risk of cracking is higher during board bending or any other stressful condition. Too little solder amount results in a lack of adhesive strength on the outer electrode termination, which may result in chips breaking loose from the PCB. Please confirm that solder has been applied smoothly is and rising to the end surface of the chip.
- 3-2. A soldering iron with a tip of ø3mm or smaller should be used. It is also necessary to keep the soldering iron from touching the components during the re-work.
- 3-3. Solder wire with ø0.5mm or smaller is required for soldering.



### 5. Washing

Excessive ultrasonic oscillation during cleaning can cause the PCBs to resonate, resulting in cracked chips or broken solder joints. Before starting your production process, test your cleaning equipment / process to insure it does not degrade the capacitors.

### 6. Electrical Test on Printed Circuit Board

1. Confirm position of the support pin or specific jig, when inspecting the electrical performance of a capacitor after mounting on the printed circuit board.
  - 1-1. Avoid bending the printed circuit board by the pressure of a test-probe, etc.  
The thrusting force of the test probe can flex the PCB, resulting in cracked chips or open solder joints. Provide support pins on the back side of the PCB to prevent warping or flexing. Install support pins as close to the test-probe as possible.
  - 1-2. Avoid vibration of the board by shock when a test -probe contacts a printed circuit board.

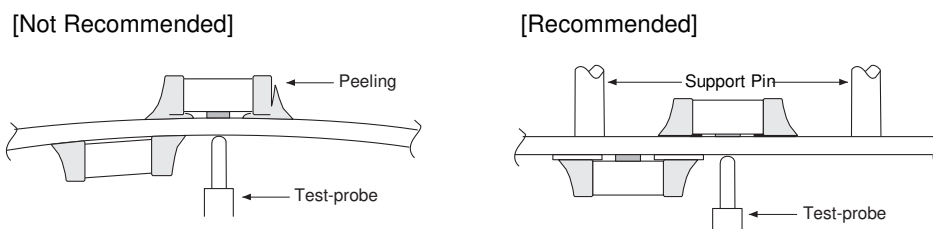

### 7. Printed Circuit Board Cropping

1. After mounting a capacitor on a printed circuit board, do not apply any stress to the capacitor that caused bending or twisting the board.
  - 1-1. In cropping the board, the stress as shown may cause the capacitor to crack.  
Cracked capacitors may cause deterioration of the insulation resistance, and result in a short. Avoid this type of stress to a capacitor.



2. Check the cropping method for the printed circuit board in advance.

2-1. Printed circuit board cropping shall be carried out by using a jig or an apparatus (Disc separator, router type separator, etc.) to prevent the mechanical stress that can occur to the board.

Board Separation Method	Hand Separation Nipper Separation	(1) Board Separation Jig	Board Separation Apparatus	
			2) Disc Separator	3) Router Type Separator
Level of stress on board	High	Medium	Medium	Low
Recommended	x	△*	△*	○
Notes	Hand and nipper separation apply a high level of stress. Use another method.	<ul style="list-style-type: none"> <li>· Board handling</li> <li>· Board bending direction</li> <li>· Layout of capacitors</li> </ul>	<ul style="list-style-type: none"> <li>· Board handling</li> <li>· Layout of slits</li> <li>· Design of V groove</li> <li>· Arrangement of blades</li> <li>· Controlling blade life</li> </ul>	Board handling

\* When a board separation jig or disc separator is used, if the following precautions are not observed, a large board deflection stress will occur and the capacitors may crack. Use router type separator if at all possible.

(1) Example of a suitable jig

[In the case of Single-side Mounting]

An outline of the board separation jig is shown as follows.

Recommended example: Stress on the component mounting position can be minimized by holding the portion close to the jig, and bend in the direction towards the side where the capacitors are mounted.

Not recommended example: The risk of cracks occurring in the capacitors increases due to large stress being applied to the component mounting position, if the portion away from the jig is held and bent in the direction opposite the side where the capacitors are mounted.

[Outline of jig]



[Hand Separation]



[In the case of Double-sided Mounting]

Since components are mounted on both sides of the board, the risk of cracks occurring can not be avoided with the above method. Therefore, implement the following measures to prevent stress from being applied to the components.

(Measures)

(1) Consider introducing a router type separator.

If it is difficult to introduce a router type separator, implement the following measures.

(Refer to item 1. Mounting Position)

(2) Mount the components parallel to the board separation surface.

(3) When mounting components near the board separation point, add slits in the separation position near the component.

(4) Keep the mounting position of the components away from the board separation point.

(2) Example of a Disc Separator

An outline of a disc separator is shown as follows. As shown in the Principle of Operation, the top blade and bottom blade are aligned with the V-grooves on the printed circuit board to separate the board.

In the following case, board deflection stress will be applied and cause cracks in the capacitors.

(1) When the adjustment of the top and bottom blades are misaligned, such as deviating in the top-bottom, left-right or front-rear directions

(2) The angle of the V groove is too low, depth of the V groove is too shallow, or the V groove is misaligned top-bottom

IF V groove is too deep, it is possible to brake when you handle and carry it. Carefully design depth of the V groove with consideration about strength of material of the printed circuit board.

[ Outline of Machine ]



[ Principle of Operation ]



[ Cross-section Diagram ]



[Disc Separator]

Recommended	Not recommended		
	Top-bottom Misalignment	Left-right Misalignment	Front-rear Misalignment
Top Blade Bottom Blade	Top Blade Bottom Blade	Top Blade Bottom Blade	Top Blade Bottom Blade

[V-groove Design]

Example of Recommended V-groove Design	Not Recommended			
	Left-right Misalignment	Low-Angle	Depth too Shallow	Depth too Deep

(3) Example of Router Type Separator

The router type separator performs cutting by a router rotating at a high speed. Since the board does not bend in the cutting process, stress on the board can be suppressed during board separation.

When attaching or removing boards to/from the router type separator, carefully handle the boards to prevent bending.

[ Outline Drawing ]

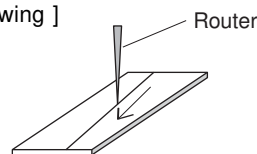

**8. Assembly**

1. Handling

If a board mounted with capacitors is held with one hand, the board may bend.

Firmly hold the edges of the board with both hands when handling.

If a board mounted with capacitors is dropped, cracks may occur in the capacitors.

Do not use dropped boards, as there is a possibility that the quality of the capacitors may be impaired.

2. Attachment of Other Components

2-1. Mounting of Other Components

Pay attention to the following items, when mounting other components on the back side of the board after capacitors have been mounted on the opposite side.

When the bottom dead point of the suction nozzle is set too low, board deflection stress may be applied to the capacitors on the back side (bottom side), and cracks may occur in the capacitors.

- After the board is straightened, set the bottom dead point of the nozzle on the upper surface of the board.
- Periodically check and adjust the bottom dead point.

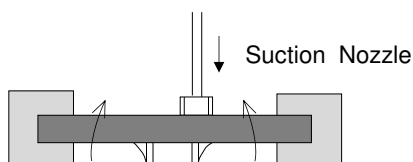

2-2. Inserting Components with Leads into Boards

When inserting components (transformers, IC, etc.) into boards, bending the board may cause cracks in the capacitors or cracks in the solder. Pay attention to the following.

- Increase the size of the holes to insert the leads, to reduce the stress on the board during insertion.
- Fix the board with support pins or a dedicated jig before insertion.
- Support below the board so that the board does not bend. When using support pins on the board, periodically confirm that there is no difference in the height of each support pin.

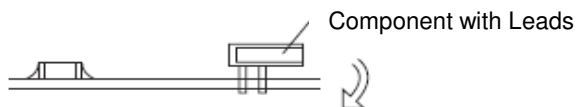

2-3. Attaching/Removing Sockets and/or Connectors

Insertion and removal of sockets and connectors, etc., might cause the board to bend.

Please insure that the board does not warp during insertion and removal of sockets and connectors, etc., or the bending may damage mounted components on the board.



2-4. Tightening Screws

The board may be bent, when tightening screws, etc. during the attachment of the board to a shield or chassis. Pay attention to the following items before performing the work.

- Plan the work to prevent the board from bending.
- Use a torque screwdriver, to prevent over-tightening of the screws.
- The board may bend after mounting by reflow soldering, etc. Please note, as stress may be applied to the chips by forcibly flattening the board when tightening the screws.

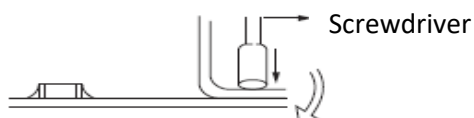

## ■ Others

### 1. Under Operation of Equipment

- 1-1. Do not touch a capacitor directly with bare hands during operation in order to avoid the danger of an electric shock.
- 1-2. Do not allow the terminals of a capacitor to come in contact with any conductive objects (short-circuit).  
Do not expose a capacitor to a conductive liquid, inducing any acid or alkali solutions.
- 1-3. Confirm the environment in which the equipment will operate is under the specified conditions.  
Do not use the equipment under the following environments.
  - (1) Being splattered with water or oil.
  - (2) Being exposed to direct sunlight.
  - (3) Being exposed to ozone, ultraviolet rays, or radiation.
  - (4) Being exposed to toxic gas (e.g., hydrogen sulfide, sulfur dioxide, chlorine, ammonia gas etc.)
  - (5) Any vibrations or mechanical shocks exceeding the specified limits.
  - (6) Moisture condensing environments.
- 1-4. Use damp proof countermeasures if using under any conditions that can cause condensation.

### 2. Others

- 2-1. In an Emergency
  - (1) If the equipment should generate smoke, fire, or smell, immediately turn off or unplug the equipment.  
If the equipment is not turned off or unplugged, the hazards may be worsened by supplying continuous power.
  - (2) In this type of situation, do not allow face and hands to come in contact with the capacitor or burns may be caused by the capacitor's high temperature.
- 2-2. Disposal of waste  
When capacitors are disposed of, they must be burned or buried by an industrial waste vendor with the appropriate licenses.
- 2-3. Circuit Design
  - (1) Addition of Fail Safe Function  
Capacitors that are cracked by dropping or bending of the board may cause deterioration of the insulation resistance, and result in a short. If the circuit being used may cause an electrical shock, smoke or fire when a capacitor is shorted, be sure to install fail-safe functions, such as a fuse, to prevent secondary accidents.
  - (2) This series are not safety standard certified products.
- 2-4. Remarks  
Failure to follow the cautions may result, worst case, in a short circuit and smoking when the product is used. The above notices are for standard applications and conditions. Contact us when the products are used in special mounting conditions.  
Select optimum conditions for operation as they determine the reliability of the product after assembly. The data herein are given in typical values, not guaranteed ratings.

## ■ Rating

### 1. Operating Temperature

1. The operating temperature limit depends on the capacitor.
  - 1-1. Do not apply temperatures exceeding the maximum operating temperature.  
It is necessary to select a capacitor with a suitable rated temperature that will cover the operating temperature range.  
It is also necessary to consider the temperature distribution in equipment and the seasonal temperature variable factor.
  - 1-2. Consider the self-heating factor of the capacitor  
The surface temperature of the capacitor shall not exceed the maximum operating temperature including self-heating.

### 2. Atmosphere Surroundings (gaseous and liquid)

1. Restriction on the operating environment of capacitors.
  - 1-1. The capacitor will short-circuit by water or brine. It may shorten the lifetime and may have the failure by the corrosion of terminals and the permeation of moisture into capacitor.
  - 1-2. The same phenomenon as the above may occur when the electrodes or terminals of the capacitor are subject to moisture condensation.
  - 1-3. The deterioration of characteristics and insulation resistance due to the oxidization or corrosion of terminal electrodes may result in breakdown when the capacitor is exposed to corrosive or volatile gases or solvents for long periods of time.

### 3. Piezo-electric Phenomenon

1. When using high dielectric constant type capacitors in AC or pulse circuits, the capacitor itself vibrates at specific frequencies and noise may be generated.  
Moreover, when the mechanical vibration or shock is added to capacitor, noise may occur.



■ Soldering and Mounting

1. PCB Design

1. Notice for Pattern Forms

1-1. Unlike leaded components, chip components are susceptible to flexing stresses since they are mounted directly on the substrate. They are also more sensitive to mechanical and thermal stresses than leaded components. Excess solder fillet height can multiply these stresses and cause chip cracking. When designing substrates, take land patterns and dimensions into consideration to eliminate the possibility of excess solder fillet height.

1-2. There is a possibility of chip cracking caused by PCB expansion/contraction with heat, because stress on a chip is different depending on PCB material and structure. When the thermal expansion coefficient greatly differs between the board used for mounting and the chip, it will cause cracking of the chip due to the thermal expansion and contraction. When capacitors are mounted on a fluorine resin printed circuit board or on a single-layered glass epoxy board, it may also cause cracking of the chip for the same reason.

1-3. If you are replacing by smaller capacitors, you should not only consider the Land size change but also consider changing the Wiring Width, Wiring direction, and copper foil thickness because the risk of chip cracking is increased with just a Land size change.

Pattern Forms

	Prohibited	Correct
Placing Close to Chassis		
Placing of Chip Components and Leaded Components		
Placing of Leaded Components after Chip Component		
Lateral Mounting		

2. Land Dimensions

Please confirm the suitable land dimension by evaluating of the actual SET / PCB.



Table 1 Flow Soldering Method

Series	Chip Dimension (L/W) Code	Chip(L×W)	a	b	c
GRT	18	1.6×0.8	0.6 to 1.0	0.8 to 0.9	0.6 to 0.8
GRT	21	2.0×1.25	1.0 to 1.2	0.9 to 1.0	0.8 to 1.1
GRT	31	3.2×1.6	2.2 to 2.6	1.0 to 1.1	1.0 to 1.4

Flow soldering can only be used for products with a chip size of 1.6x0.8mm to 3.2x1.6mm. (in mm)  
Resistance to PCB bending stress may be improved by designing the “a” dimension with solder resist.

Table 2 Reflow Soldering Method

Series	Chip Dimension (L/W) Code	Chip(L×W) (Dimensions Tolerance)	a	b	c
GRT	03	0.6×0.3 (±0.03)	0.2 to 0.25	0.2 to 0.3	0.25 to 0.35
		0.6×0.3 (±0.05)	0.2 to 0.25	0.25 to 0.35	0.3 to 0.4
		0.6×0.3 (±0.09)	0.23 to 0.3	0.25 to 0.35	0.3 to 0.4
GRT	15	1.0×0.5 (within ±0.10)	0.3 to 0.5	0.35 to 0.45	0.4 to 0.6
		1.0×0.5 (±0.15/±0.20)	0.4 to 0.6	0.4 to 0.5	0.5 to 0.7
GRT	18	1.6×0.8 (±0.10)	0.6 to 0.8	0.6 to 0.7	0.6 to 0.8
		1.6×0.8 (±0.15/±0.20)	0.7 to 0.9	0.7 to 0.8	0.8 to 1.0
GRT	21	2.0×1.25 (±0.10)	1.2	0.6	1.25
		2.0×1.25 (±0.15)	1.2	0.6 to 0.8	1.2 to 1.4
		2.0×1.25 (±0.20)	1.0 to 1.4	0.6 to 0.8	1.2 to 1.4
GRT	31	3.2×1.6 (within ±0.20)	1.8 to 2.0	0.9 to 1.2	1.5 to 1.7
		3.2×1.6 (±0.30)	1.9 to 2.1	1.0 to 1.3	1.7 to 1.9
GRT	32	3.2×2.5	2.0 to 2.4	1.0 to 1.2	1.8 to 2.3

(in mm)

### 3. Board Design

When designing the board, keep in mind that the amount of strain which occurs will increase depending on the size and material of the board.

Relationship with amount of strain to the board thickness, length, width, etc.]

$$\epsilon = \frac{3PL}{2Ewh^2}$$

Relationship between load and strain



$\epsilon$  : Strain on center of board ( $\mu\text{st}$ )  
 $L$  : Distance between supporting points (mm)  
 $w$  : Board width (mm)  
 $h$  : Board thickness (mm)  
 $E$  : Elastic modulus of board ( $\text{N/m}^2=\text{Pa}$ )  
 $Y$  : Deflection (mm)  
 $P$  : Load (N)

When the load is constant, the following relationship can be established.

- As the distance between the supporting points (L) increases, the amount of strain also increases.
- Reduce the distance between the supporting points.
- As the elastic modulus (E) decreases, the amount of strain increases.
- Increase the elastic modulus.
- As the board width (w) decreases, the amount of strain increases.
- Increase the width of the board.
- As the board thickness (h) decreases, the amount of strain increases.
- Increase the thickness of the board.

Since the board thickness is squared, the effect on the amount of strain becomes even greater.

### 2. Item to be confirmed for Flow soldering

If you want to temporarily attach the capacitor to the board using an adhesive agent before soldering the capacitor, first be sure that the conditions are appropriate for affixing the capacitor. If the dimensions of the land, the type of adhesive, the amount of coating, the contact surface area, the curing temperature, or other conditions are inappropriate, the characteristics of the capacitor may deteriorate.

#### 1. Selection of Adhesive

- 1-1. Depending on the type of adhesive, there may be a decrease in insulation resistance. In addition, there is a chance that the capacitor might crack from contractile stress due to the difference in the contraction rate of the capacitor and the adhesive.
- 1-2. If there is not enough adhesive, the contact surface area is too small, or the curing temperature or curing time are inadequate, the adhesive strength will be insufficient and the capacitor may loosen or become disconnected during transportation or soldering. If there is too much adhesive, for example if it overflows onto the land, the result could be soldering defects, loss of electrical connection, insufficient curing, or slippage after the capacitor is mounted. Furthermore, if the curing temperature is too high or the curing time is too long, not only will the adhesive strength be reduced, but solderability may also suffer due to the effects of oxidation on the terminations (outer electrodes) of the capacitor and the land surface on the board.

##### (1) Selection of Adhesive

Epoxy resins are a typical class of adhesive. To select the proper adhesive, consider the following points.

- 1) There must be enough adhesive strength to prevent the component from loosening or slipping during the mounting process.
- 2) The adhesive strength must not decrease when exposed to moisture during soldering.
- 3) The adhesive must have good coatability and shape retention properties.
- 4) The adhesive must have a long pot life.
- 5) The curing time must be short.
- 6) The adhesive must not be corrosive to the exterior of the capacitor or the board.
- 7) The adhesive must have good insulation properties.
- 8) The adhesive must not emit toxic gases or otherwise be harmful to health.
- 9) The adhesive must be free of halogenated compounds.

##### (2) Use the following illustration as a guide to the amount of adhesive to apply.

Chip(L×W): 1.6×0.8mm/2.0×1.25mm/3.2×1.6mm



**2.Flux**

- 2-1. An excessive amount of flux generates a large quantity of flux gas, which can cause a deterioration of solderability, so apply flux thinly and evenly throughout. (A foaming system is generally used for flow soldering.)
- 2-2. Flux containing too high a percentage of halide may cause corrosion of the terminations unless there is sufficient cleaning. Use flux with a halide content of 0.1% max.
- 2-3. Strong acidic flux can corrode the capacitor and degrade its performance. Please check the quality of capacitor after mounting.

**3.Leaching of the terminations**

Set temperature and time to ensure that leaching of the terminations does not exceed 25% of the chip end area as a single chip (full length of the edge A-B-C-D shown at right) and 25% of the length A-B shown as mounted on substrate.



**3.Reflow soldering**

The flux in the solder paste contains halogen-based substances and organic acids as activators. Strong acidic flux can corrode the capacitor and degrade its performance. Please check the quality of capacitor after mounting.

**4.Washing**

- 1. Please evaluate the capacitor using actual cleaning equipment and conditions to confirm the quality, and select the solvent for cleaning.
- 2. Unsuitable cleaning may leave residual flux or other foreign substances, causing deterioration of electrical characteristics and the reliability of the capacitors.

**5.Coating**

- 1. A crack may be caused in the capacitor due to the stress of the thermal contraction of the resin during curing process. The stress is affected by the amount of resin and curing contraction. Select a resin with low curing contraction. The difference in the thermal expansion coefficient between a coating resin or a molding resin and the capacitor may cause the destruction and deterioration of the capacitor such as a crack or peeling, and lead to the deterioration of insulation resistance or dielectric breakdown. Select a resin for which the thermal expansion coefficient is as close to that of the capacitor as possible. A silicone resin can be used as an under-coating to buffer against the stress.
- 2. Select a resin that is less hygroscopic. Using hygroscopic resins under high humidity conditions may cause the deterioration of the insulation resistance of a capacitor. An epoxy resin can be used as a less hygroscopic resin.
- 3. The halogen system substance and organic acid are included in coating material, and a chip corrodes by the kind of Coating material. Do not use strong acid type.

## ■ Others

### 1. Transportation

1. The performance of a capacitor may be affected by the conditions during transportation.

1-1. The capacitors shall be protected against excessive temperature, humidity and mechanical force during transportation.

·Mechanical condition

Transportation shall be done in such a way that the boxes are not deformed and forces are not directly passed on to the inner packaging.

1-2. Do not apply excessive vibration, shock, or pressure to the capacitor.

(1) When excessive mechanical shock or pressure is applied to a capacitor, chipping or cracking may occur in the ceramic body of the capacitor.

(2) When the sharp edge of an air driver, a soldering iron, tweezers, a chassis, etc. impacts strongly on the surface of the capacitor, the capacitor may crack and short-circuit.

1-3. Do not use a capacitor to which excessive shock was applied by dropping etc.

A capacitor dropped accidentally during processing may be damaged.

### 2. Characteristics Evaluation in the Actual System

1. Evaluate the capacitor in the actual system, to confirm that there is no problem with the performance and specification values in a finished product before using.

2. Since a voltage dependency and temperature dependency exists in the capacitance of high dielectric type ceramic capacitors, the capacitance may change depending on the operating conditions in the actual system. Therefore, be sure to evaluate the various characteristics, such as the leakage current and noise absorptivity, which will affect the capacitance value of the capacitor.

3. In addition, voltages exceeding the predetermined surge may be applied to the capacitor by the inductance in the actual system. Evaluate the surge resistance in the actual system as required.

1. Please make sure that your product has been evaluated in view of your specifications with our product being mounted to your product.
2. You are requested not to use our product deviating from this product specification.
3. We consider it not appropriate to include any terms and conditions with regard to the business transaction in the product specifications, drawings or other technical documents. Therefore, if your technical documents as above include such terms and conditions such as warranty clause, product liability clause, or intellectual property infringement liability clause, they will be deemed to be invalid.
4. GRT series is manufactured under a quality management system compliant to ISO9001, but is not registered to ISO/TS16949.