



STPS41L45CG/CT/CR

LOW DROP POWER SCHOTTKY RECTIFIER

MAIN PRODUCTS CHARACTERISTICS

$I_{F(AV)}$	2 x 20 A
V_{RRM}	45 V
$T_j(\text{max})$	150 °C
$V_F(\text{max})$	0.47 V

FEATURES AND BENEFITS

- VERY SMALL CONDUCTION LOSSES
- NEGLIGIBLE SWITCHING LOSSES
- EXTREMELY FAST SWITCHING
- LOW FORWARD VOLTAGE DROP
- LOW THERMAL RESISTANCE
- AVALANCHE CAPABILITY SPECIFIED

DESCRIPTION

Dual center tab Schottky rectifier suited for 5V output in off line AC/DC power supplies.

Packaged in D²PAK, I₂PAK and TO-220AB this device is intended for use in low voltage, high frequency inverters, free-wheeling and polarity protection applications.

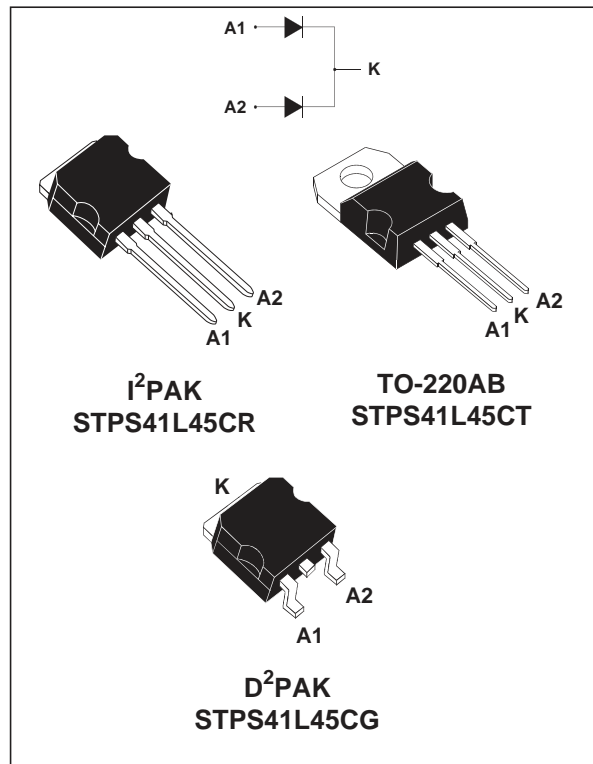

ABSOLUTE RATINGS (limiting values, per diode)

Symbol	Parameter		Value	Unit
V_{RRM}	Repetitive peak reverse voltage		45	V
$I_{F(RMS)}$	RMS forward current		30	A
$I_{F(AV)}$	Average forward current	$T_c = 130^\circ\text{C}$ $\delta = 0.5$	Per diode: 20 Per device: 40	A
I_{FSM}	Surge non repetitive forward current	$t_p = 10 \text{ ms}$ sinusoidal	220	A
I_{RRM}	Peak repetitive reverse current	$t_p = 2 \mu\text{s}$ square $F = 1\text{kHz}$	1	A
P_{ARM}	Repetitive peak avalanche power	$t_p = 1 \mu\text{s}$ $T_j = 25^\circ\text{C}$	10000	W
T_{stg}	Storage temperature range		- 65 to + 175	°C
T_j	Maximum operating junction temperature *		150	°C
dV/dt	Critical rate of rise reverse voltage		10000	V/ μs

* : $\frac{dP_{tot}}{dT_j} < \frac{1}{R_{th(j-a)}}$ thermal runaway condition for a diode on its own heatsink

STPS41L45CG / STPS41L45CT / STPS41L45CR

THERMAL RESISTANCES

Symbol	Parameter		Value	Unit
$R_{th(j-c)}$	Junction to case	Per diode	1.5	$^{\circ}\text{C/W}$
		Total	0.8	
$R_{th(c)}$	Coupling		0.1	

When the diodes 1 and 2 are used simultaneously :

$$\Delta T_j(\text{diode 1}) = P(\text{diode 1}) \times R_{th(j-c)}(\text{Per diode}) + P(\text{diode 2}) \times R_{th(c)}$$

STATIC ELECTRICAL CHARACTERISTICS (per diode)

Symbol	Parameter	Tests Conditions		Min.	Typ.	Max.	Unit
I_R^*	Reverse leakage current	$T_j = 25^{\circ}\text{C}$	$V_R = V_{RRM}$			1.2	mA
		$T_j = 125^{\circ}\text{C}$			110	220	mA
V_F^*	Forward voltage drop	$T_j = 25^{\circ}\text{C}$	$I_F = 20\text{ A}$			0.53	V
		$T_j = 125^{\circ}\text{C}$	$I_F = 20\text{ A}$		0.42	0.47	
		$T_j = 25^{\circ}\text{C}$	$I_F = 40\text{ A}$			0.68	
		$T_j = 125^{\circ}\text{C}$	$I_F = 40\text{ A}$		0.60	0.66	

Pulse test : * $t_p = 380\ \mu\text{s}$, $\delta < 2\%$

To evaluate the conduction losses use the following equation :

$$P = 0.28 \times I_{F(AV)} + 0.0095 I_{F(RMS)}^2$$

Fig. 1: Conduction losses versus average current.

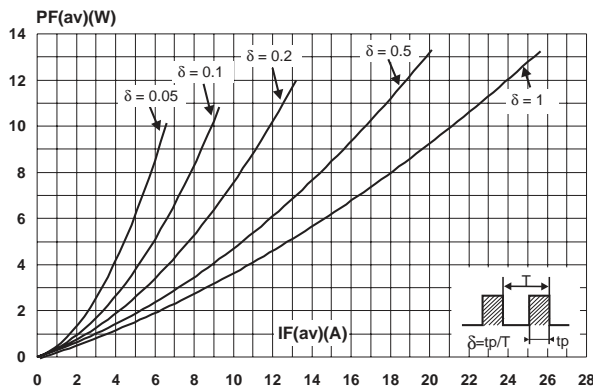

Fig. 2: Average forward current versus ambient temperature ($\delta = 0.5$).

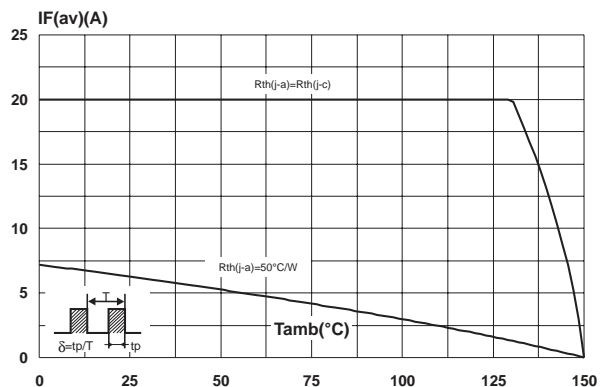

Fig. 3: Normalized avalanche power derating versus pulse duration.

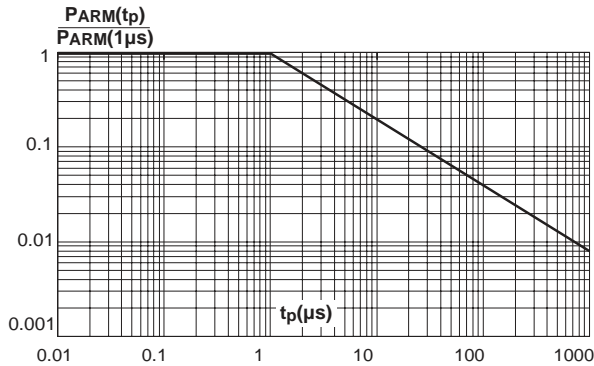

Fig. 4: Normalized avalanche power derating versus junction temperature.

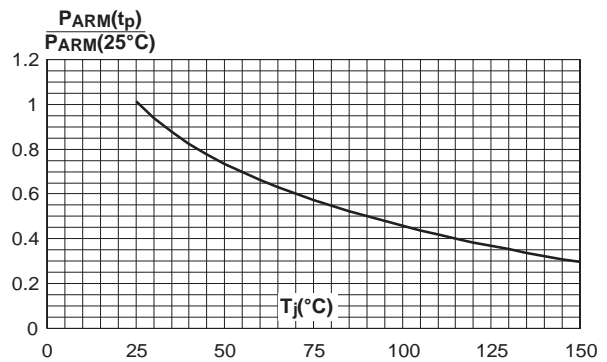

Fig. 5: Non repetitive surge peak forward current versus overload duration (maximum values).

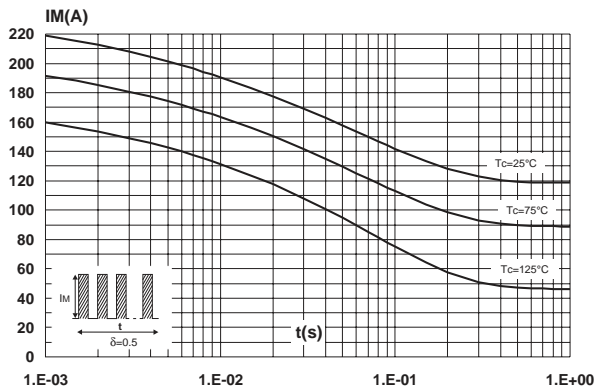

Fig. 6: Relative variation of thermal impedance junction to case versus pulse duration.

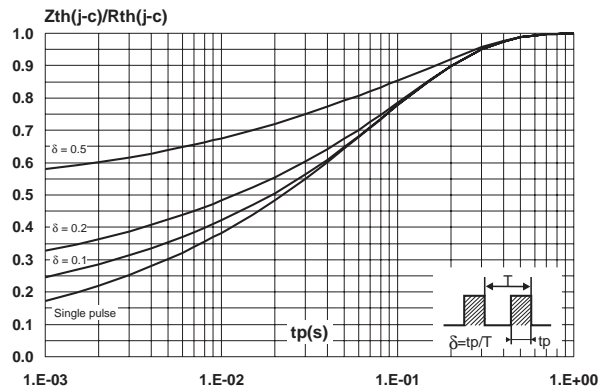

Fig. 7: Reverse leakage current versus reverse voltage applied (typical values).

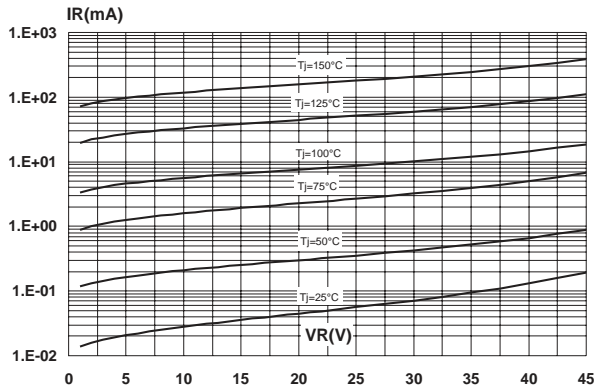
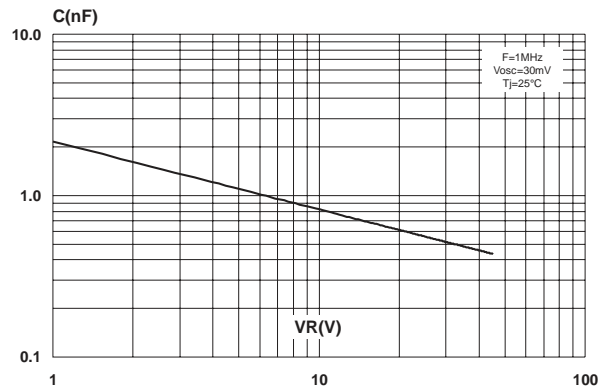

Fig. 8: Junction capacitance versus reverse voltage applied (typical values).



STPS41L45CG / STPS41L45CT / STPS41L45CR

Fig. 9: Forward voltage drop versus forward current.

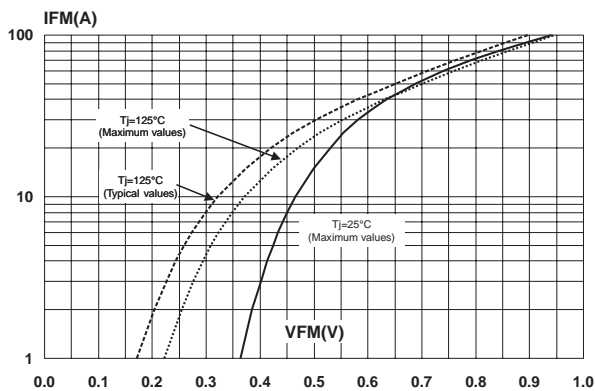
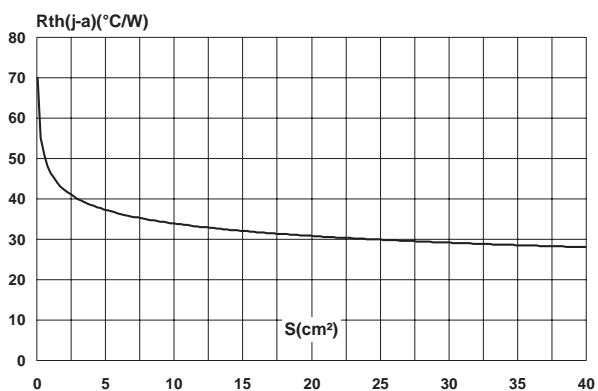

Fig. 10: Thermal resistance junction to ambient versus copper surface under tab (epoxy printed board FR4, Cu = 35µm) (STPS41L45CG only).



PACKAGE MECHANICAL DATA

D²PAK

* FLAT ZONE NO LESS THAN 2mm

REF.	DIMENSIONS			
	Millimeters		Inches	
	Min.	Max.	Min.	Max.
A	4.40	4.60	0.173	0.181
A1	2.49	2.69	0.098	0.106
A2	0.03	0.23	0.001	0.009
B	0.70	0.93	0.027	0.037
B2	1.14	1.70	0.045	0.067
C	0.45	0.60	0.017	0.024
C2	1.23	1.36	0.048	0.054
D	8.95	9.35	0.352	0.368
E	10.00	10.40	0.393	0.409
G	4.88	5.28	0.192	0.208
L	15.00	15.85	0.590	0.624
L2	1.27	1.40	0.050	0.055
L3	1.40	1.75	0.055	0.069
M	2.40	3.20	0.094	0.126
R	0.40 typ.		0.016 typ.	
V2	0°	8°	0°	8°

FOOTPRINT (dimensions in mm)

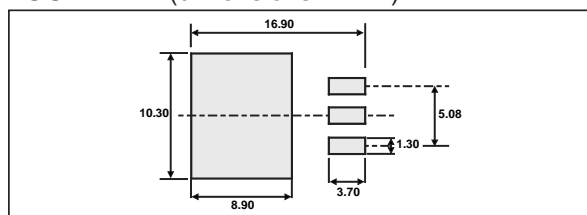

PACKAGE MECHANICAL DATA
I²PAK

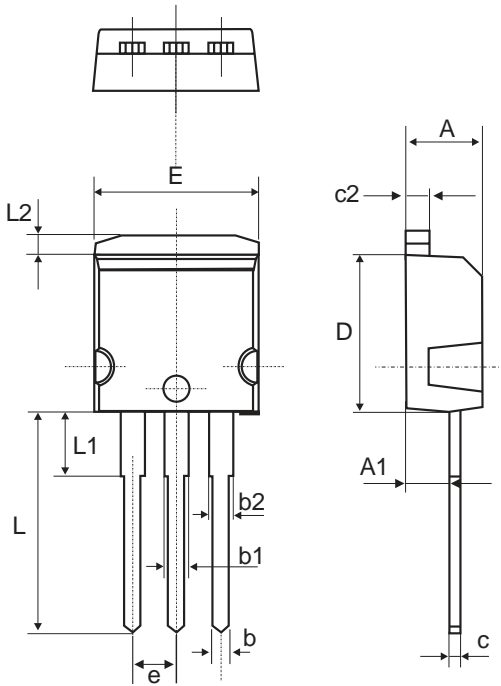

REF.	DIMENSIONS			
	Millimeters		Inches	
	Min.	Max.	Min.	Max.
A	4.40	4.60	0.173	0.181
A1	2.49	2.69	0.098	0.106
b	0.70	0.93	0.028	0.037
b1	1.14	1.17	0.044	0.046
b2	1.14	1.17	0.044	0.046
c	0.45	0.60	0.018	0.024
c2	1.23	1.36	0.048	0.054
D	8.95	9.35	0.352	0.368
e	2.40	2.70	0.094	0.106
E	10.0	10.4	0.394	0.409
L	13.1	13.6	0.516	0.535
L1	3.48	3.78	0.137	0.149
L2	1.27	1.40	0.050	0.055

STPS41L45CG / STPS41L45CT / STPS41L45CR

PACKAGE MECHANICAL DATA
TO-220AB

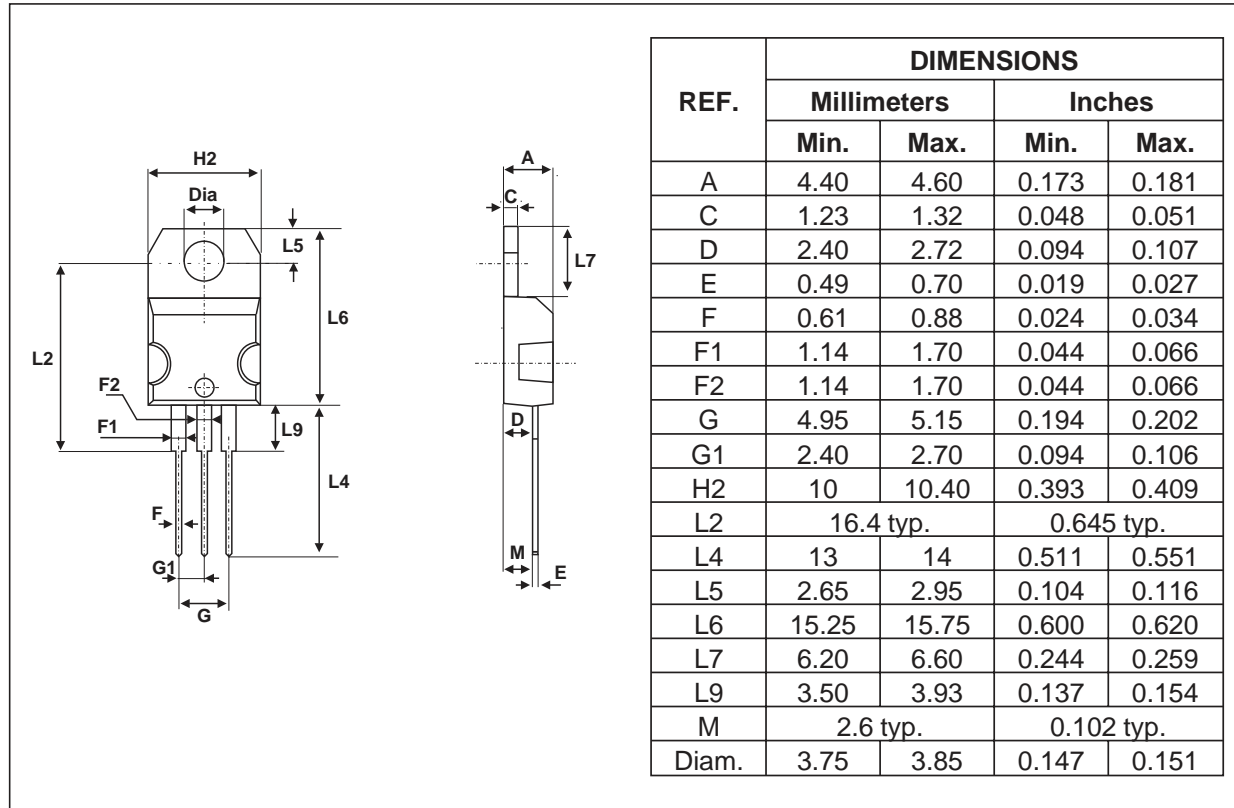

Ordering type	Marking	Package	Weight	Base qty	Delivery mode
STPS41L45CG	STPS41L45CG	D ² PAK	1.48 g	50	Tube
STPS41L45CG-TR	STPS41L45CG	D ² PAK	1.48 g	1000	Tape & reel
STPS41L45CT	STPS41L45CT	TO-220AB	2.20 g	50	Tube
STPS41L45CR	STPS41L45CR	I ² PAK	1.49 g	50	Tube

■ EPOXY MEETS UL94,V0

Information furnished is believed to be accurate and reliable. However, STMicroelectronics assumes no responsibility for the consequences of use of such information nor for any infringement of patents or other rights of third parties which may result from its use. No license is granted by implication or otherwise under any patent or patent rights of STMicroelectronics. Specifications mentioned in this publication are subject to change without notice. This publication supersedes and replaces all information previously supplied. STMicroelectronics products are not authorized for use as critical components in life support devices or systems without express written approval of STMicroelectronics.

The ST logo is a registered trademark of STMicroelectronics
 © 2003 STMicroelectronics - Printed in Italy - All rights reserved.
 STMicroelectronics GROUP OF COMPANIES
 Australia - Brazil - Canada - China - Finland - France - Germany
 Hong Kong - India - Israel - Italy - Japan - Malaysia - Malta - Morocco - Singapore
 Spain - Sweden - Switzerland - United Kingdom - United States.

<http://www.st.com>

