

POM-2738L-R Omni-Directional Microphone



3541 Stop Eight Road • Dayton, Ohio 45414

Product Overview

- 6mm overall diameter and 2.7mm height with solder pads
- -38 dB sensitivity for use in most environments
- Wide 2 to 10 VDC operating voltage and 50-16,000 Hz frequency response
- 60 dB signal-to-noise ratio and 2.2 kOhm impedance
- Omni-directional polar pattern for great off-axis response

Typical Frequency Response and Sensitivity

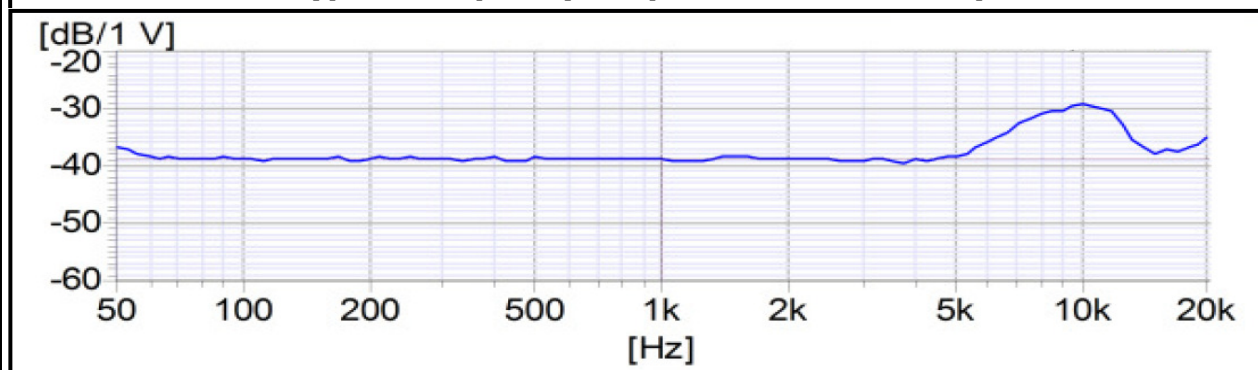

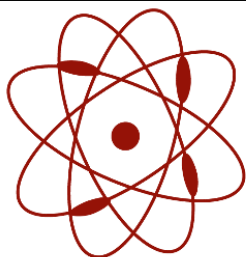

pui
audio™ inc
a projects unlimited company

POM-2738L-R Omni-Directional Microphone

Mechanical and Environment Testing	
Test Description	Test Condition
High Temperature	70°C with random humidity for 200 hours
Low Temperature	-40°C with random humidity for 200 hours
Humidity	40°C with 90% relative humidity for 200 hours
Vibration	3 mm movement for 3 minutes in each of 3 axis
Drop Test	70 cm free fall onto 20 mm thick board, two directions
Temperature Cycle Test	-40°C to 70°C, 5 cycles

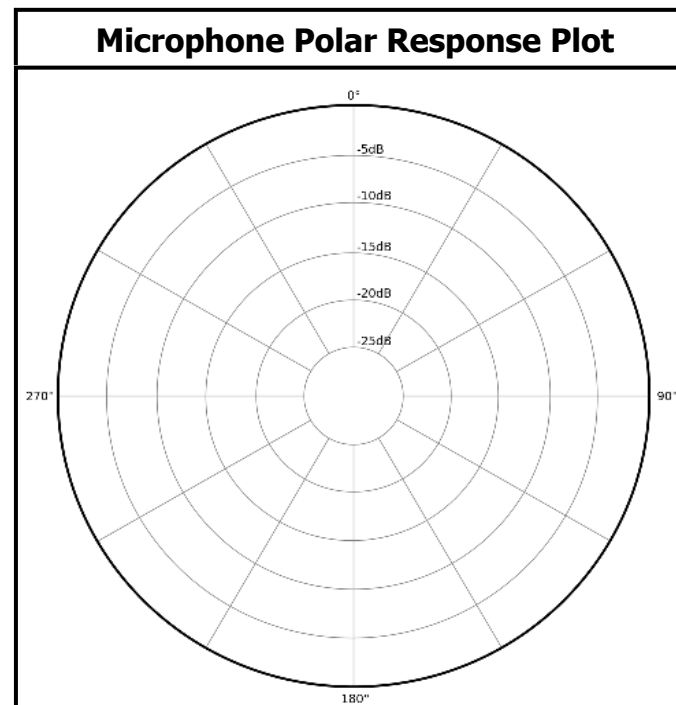
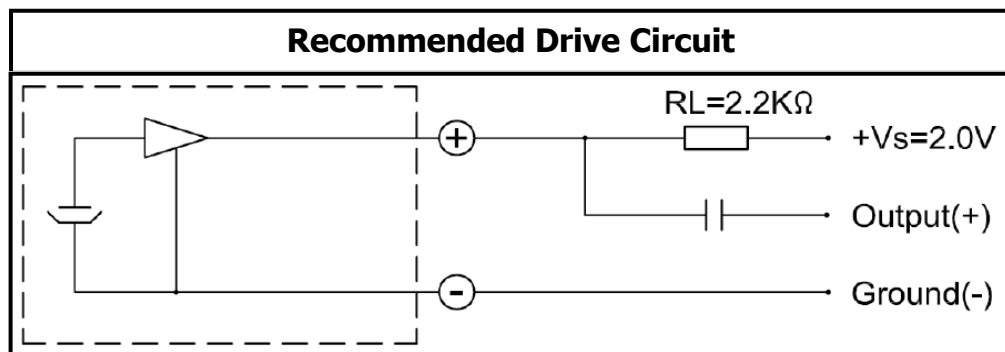

SPECIFICATIONS

PARAMETERS	VALUES	UNIT
DIRECTIVITY	OMINI	-
SENSITIVITY	-38 ± 3	dB
STANDARD OPERATING VOLTAGE	2	Vdc
MAX OPERATING VOLTAGE	10	Vdc
CURRENT CONSUMPTION (MAX)	0.5	mA
IMPEDANCE	2.2	KOhm
SIGNAL TO NOISE RATIO (MIN.)	60	dB
TERMINAL	SOLDER PADS	-
INTERNAL CAPACITOR	N/A	pF

THIS DOCUMENT CONTAINS DATA PROPRIETARY TO PROJECTS UNLIMITED, INC. ANY USE OR REPRODUCTION, IN ANY FORM, WITHOUT PRIOR WRITTEN PERMISSION OF PROJECTS UNLIMITED, INC. IS PROHIBITED.
©2003, Projects Unlimited Inc.

REVISION HISTORY

LTR	DESCRIPTION	DATE	APPROVED
-	RELEASED FROM ENGINEERING	1/25/2006	
A	ADDED TERMINAL POLARITY	2/2/2007	D.F.
B	REVISED TO INVENTOR 3-D DRAWING TEMPLATE	10/5/2010	B.R.

Ø6 ± 0.1

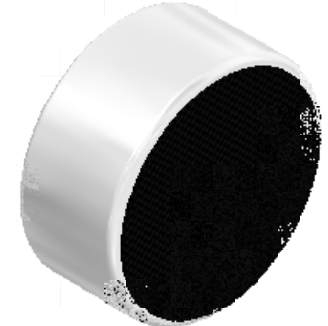
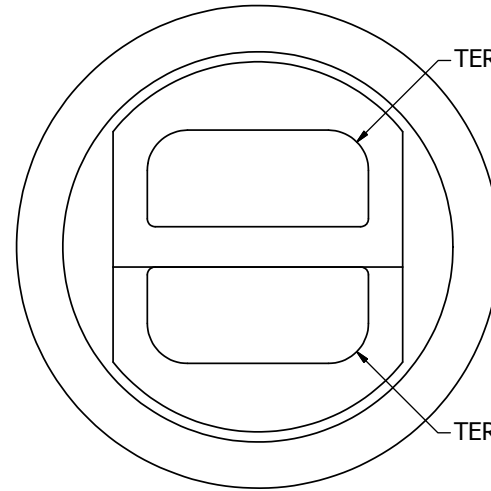
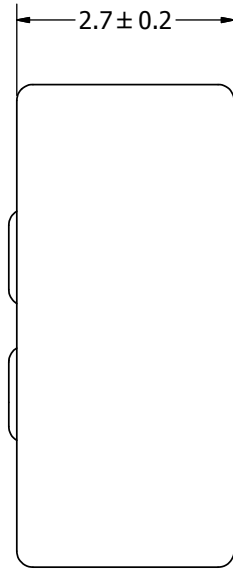
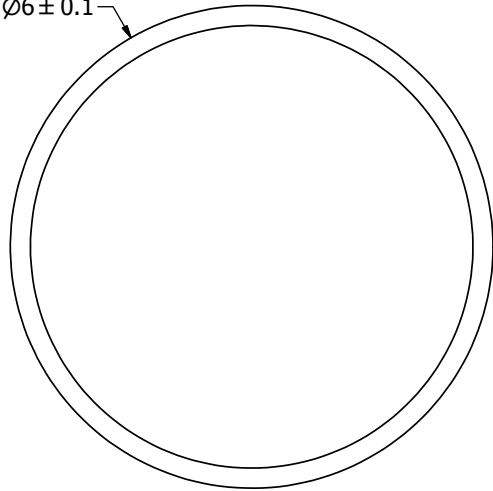

NOTES:

1. ALL DIMENSIONS ARE IN MILLIMETERS.
2. SPECIFICATIONS SUBJECT TO CHANGE OR WITHDRAWAL WITHOUT NOTICE.
3. THIS PART IS RoHS 2002/95/EC COMPLIANT.

UNLESS OTHERWISE SPECIFIED: DIMENSIONS ARE IN MILLIMETERS, TOLERANCES ARE ±0.5 AND ANGLES ARE ±3°.	SIZE	Designed by	Date	Checked by	Date	Approved by	Date	Drawn Date
	A3	J.A.F.	1/25/2006	E.P.	1/25/2006	B.R.	1/25/2006	10/5/2010
	POM-2738L-R.idw				POM-2738L-R		Edition	Sheet
Microphone						-	1 / 1	