

128K x 16 Static RAM

Features

- Pin equivalent to CY7C1011BV33
- High speed
 - $t_{AA} = 10 \text{ ns}$
- Low active power
 - 360 mW (max.)
- Data Retention at 2.0
- Automatic power-down when deselected
- Independent control of upper and lower bits
- Easy memory expansion with \overline{CE} and \overline{OE} features
- Available in 44-pin TSOP II, 44-pin TQFP, and 48-ball VFBGA
- Also available in Lead-Free 44-pin TSOP II and 44-pin TQFP packages

Functional Description

The CY7C1011CV33 is a high-performance CMOS Static RAM organized as 131,072 words by 16 bits.

Writing to the device is accomplished by taking Chip Enable (\overline{CE}) and Write Enable (\overline{WE}) inputs LOW. If Byte Low Enable (\overline{BLE}) is LOW, then data from I/O pins (I/O₀ through I/O₇), is written into the location specified on the address pins (A₀ through A₁₆). If Byte High Enable (\overline{BHE}) is LOW, then data from I/O pins (I/O₈ through I/O₁₅) is written into the location specified on the address pins (A₀ through A₁₆).

Reading from the device is accomplished by taking Chip Enable (\overline{CE}) and Output Enable (\overline{OE}) LOW while forcing the Write Enable (\overline{WE}) HIGH. If Byte Low Enable (\overline{BLE}) is LOW, then data from the memory location specified by the address pins will appear on I/O₀ to I/O₇. If Byte High Enable (\overline{BHE}) is LOW, then data from memory will appear on I/O₈ to I/O₁₅. See the truth table at the back of this data sheet for a complete description of read and write modes.

The input/output pins (I/O₀ through I/O₁₅) are placed in a high-impedance state when the device is deselected (\overline{CE} HIGH), the outputs are disabled (\overline{OE} HIGH), the \overline{BHE} and \overline{BLE} are disabled (\overline{BHE} , \overline{BLE} HIGH), or during a write operation (\overline{CE} LOW, and \overline{WE} LOW).

The CY7C1011CV33 is available in a standard 44-pin TSOP II package with center power and ground pinout, a 44-pin Thin Plastic Quad Flatpack (TQFP), as well as a 48-ball fine-pitch ball grid array (VFBGA) package.

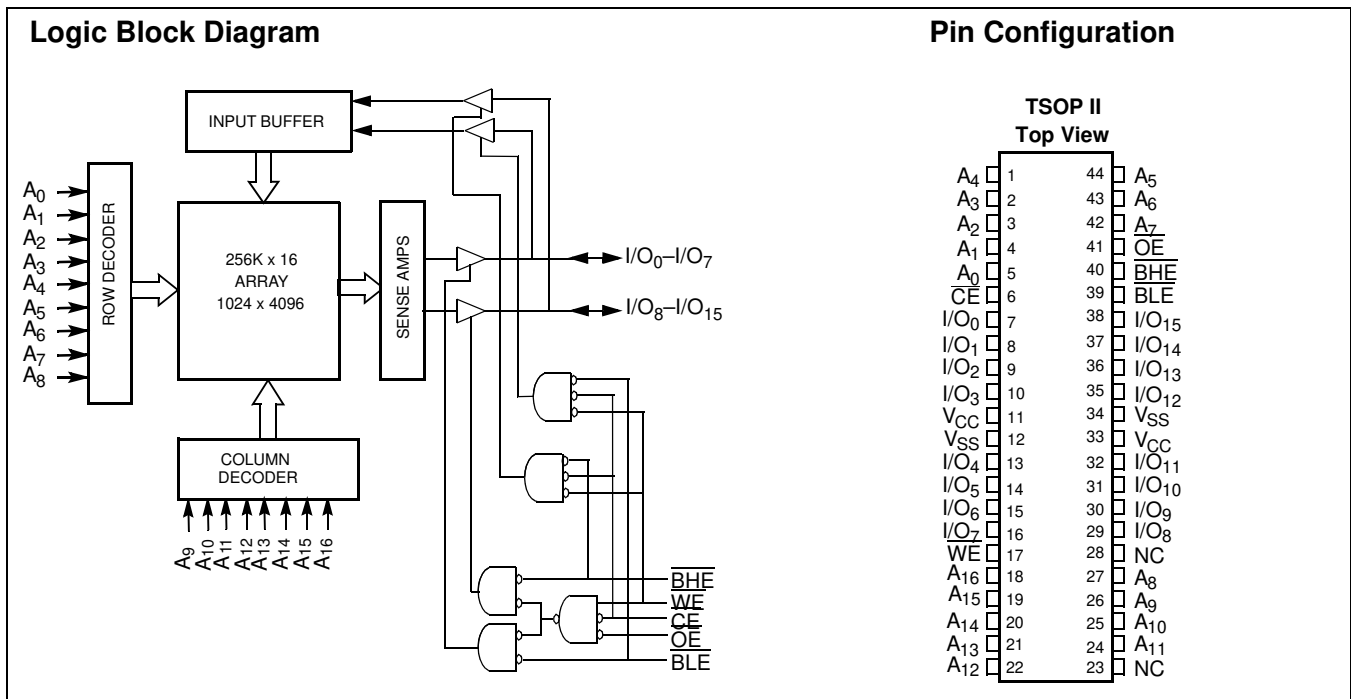

Selection Guide

		-10	-12	-15	Unit	
Maximum Access Time		10	12	15	ns	
Maximum Operating Current	Com'l	90	85	80	mA	
	Ind'l	100	95	90		
Maximum CMOS Standby Current		Com'l/Ind'l	10	10	10	mA

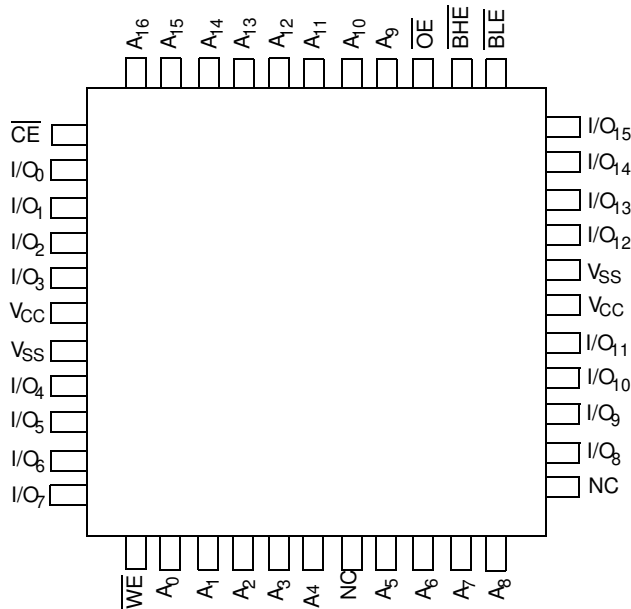
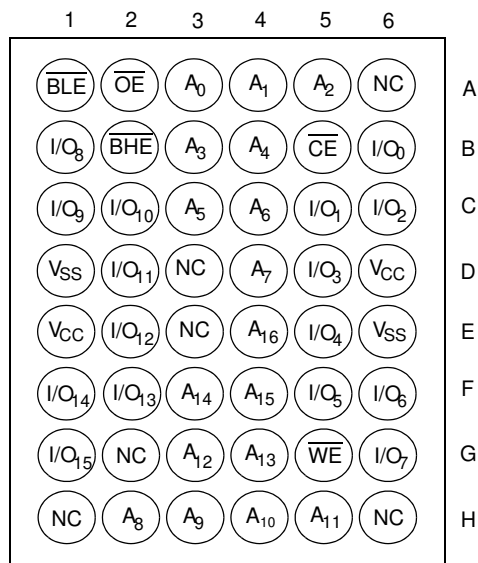
Pin Configurations
**44-pin TQFP
(Top View)**

**48-ball VFBGA
(Top View)**

Maximum Ratings

(Above which the useful life may be impaired. For user guidelines, not tested.)

Storage Temperature -65°C to +150°C

Ambient Temperature with Power Applied -55°C to +125°C

Supply Voltage on V_{CC} to Relative GND^[2] -0.5V to +4.6V

DC Voltage Applied to Outputs in High-Z State^[2] -0.5V to V_{CC} + 0.5V

DC Input Voltage^[2] -0.5V to V_{CC} + 0.5V

Current into Outputs (LOW) 20 mA

Operating Range

Range	Ambient Temperature	V _{CC}
Commercial	0°C to +70°C	3.3V ± 0.3V
Industrial	-40°C to +85°C	

DC Electrical Characteristics Over the Operating Range

Parameter	Description	Test Conditions	-10		-12		-15		Unit
			Min.	Max.	Min.	Max.	Min.	Max.	
V _{OH}	Output HIGH Voltage	V _{CC} = Min., I _{OH} = -4.0 mA	2.4		2.4		2.4		V
V _{OL}	Output LOW Voltage	V _{CC} = Min., I _{OL} = 8.0 mA		0.4		0.4		0.4	V
V _{IH}	Input HIGH Voltage		2.0	V _{CC} + 0.3	2.0	V _{CC} + 0.3	2.0	V _{CC} + 0.3	V
V _{IL}	Input LOW Voltage ^[1]		-0.3	0.8	-0.3	0.8	-0.3	0.8	V
I _{IX}	Input Load Current	GND ≤ V _I ≤ V _{CC}	-1	+1	-1	+1	-1	+1	μA
I _{OZ}	Output Leakage Current	GND ≤ V _{OUT} ≤ V _{CC} , Output Disabled	-1	+1	-1	+1	-1	+1	μA
I _{CC}	V _{CC} Operating Supply Current	V _{CC} = Max., f = f _{MAX} = 1/t _{RC}	Com'l	90		85		80	mA
			Ind'l	100		95		90	mA
I _{SB1}	Automatic CE Power-down Current —TTL Inputs	Max. V _{CC} , $\overline{CE} \geq V_{IH}$ V _{IN} ≥ V _{IH} or V _{IN} ≤ V _{IL} , f = f _{MAX}		40		40		40	mA
I _{SB2}	Automatic CE Power-down Current —CMOS Inputs	Max. V _{CC} , CE ≥ V _{CC} - 0.3V, V _{IN} ≥ V _{CC} - 0.3V, or V _{IN} ≤ 0.3V, f = 0	Com'l/ Ind'l	10		10		10	mA

Capacitance^[2]

Parameter	Description	Test Conditions	Max.	Unit
C _{IN}	Input Capacitance	T _A = 25°C, f = 1 MHz, V _{CC} = 3.3V	8	pF
C _{OUT}	I/O Capacitance		8	pF

Notes:

- V_{IL} (min.) = -2.0V for pulse durations of less than 20 ns.
- Tested initially and after any design or process changes that may affect these parameters.

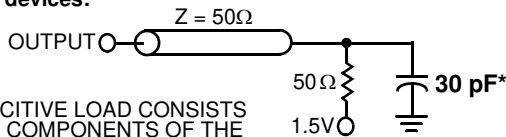
AC Test Loads and Waveforms^[3]
10-ns devices:

* CAPACITIVE LOAD CONSISTS OF ALL COMPONENTS OF THE TEST ENVIRONMENT

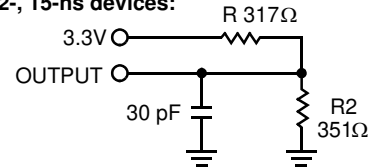
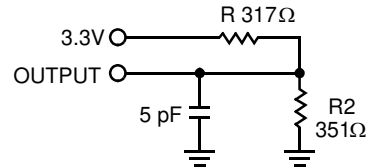
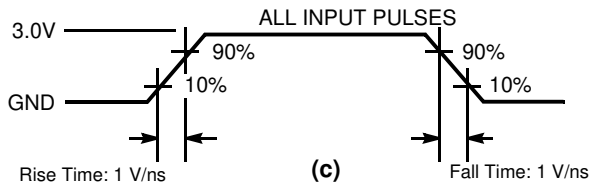
(a)
12-, 15-ns devices:

(b)
High-Z characteristics:

(d)

(c)
AC Switching Characteristics Over the Operating Range^[4]

Parameter	Description	-10		-12		-15		Unit
		Min.	Max.	Min.	Max.	Min.	Max.	
Read Cycle								
$t_{power}^{[5]}$	V_{CC} (typical) to the first access	1		1		1		μs
t_{RC}	Read Cycle Time	10		12		15		ns
t_{AA}	Address to Data Valid		10		12		15	ns
t_{OHA}	Data Hold from Address Change	3		3		3		ns
t_{ACE}	\overline{CE} LOW to Data Valid		10		12		15	ns
t_{DOE}	\overline{OE} LOW to Data Valid		5		6		7	ns
t_{LZOE}	\overline{OE} LOW to Low-Z	0		0		0		ns
t_{HZOE}	\overline{OE} HIGH to High-Z ^[6, 7]		5		6		7	ns
t_{LZCE}	\overline{CE} LOW to Low-Z ^[7]	3		3		3		ns
t_{HZCE}	\overline{CE} HIGH to High-Z ^[6, 7]		5		6		7	ns
t_{PU}	\overline{CE} LOW to Power-up	0		0		0		ns
t_{PD}	\overline{CE} HIGH to Power-down		10		12		15	ns
t_{DBE}	Byte Enable to Data Valid		5		6		7	ns
t_{LZBE}	Byte Enable to Low-Z	0		0		0		ns
t_{HZBE}	Byte Disable to High-Z		6		6		7	ns
Write Cycle^[8, 9]								
t_{WC}	Write Cycle Time	10		12		15		ns

Notes:

- AC characteristics (except High-Z) for all 10-ns parts are tested using the load conditions shown in (a). All other speeds are tested using the Thevenin load shown in (b). High-Z characteristics are tested for all speeds using the test load shown in (d).
- Test conditions assume signal transition time of 3 ns or less, timing reference levels of 1.5V, input pulse levels of 0 to 3.0V.
- t_{POWER} gives the minimum amount of time that the power supply should be at typical V_{CC} values until the first memory access is performed.
- t_{HZOE} , t_{HZCE} , and t_{HZWE} are specified with a load capacitance of 5 pF as in part (d) of AC Test Loads. Transition is measured ± 500 mV from steady-state voltage.
- At any given temperature and voltage condition, t_{HZCE} is less than t_{LZCE} , t_{HZOE} is less than t_{LZOE} , and t_{HZWE} is less than t_{LZWE} for any given device.
- The internal write time of the memory is defined by the overlap of \overline{CE} LOW, and \overline{WE} LOW. \overline{CE} and \overline{WE} must be LOW to initiate a write, and the transition of either of these signals can terminate the write. The input data set-up and hold timing should be referenced to the leading edge of the signal that terminates the write.
- The minimum write cycle time for Write Cycle No. 3 (\overline{WE} controlled, \overline{OE} LOW) is the sum of t_{HZWE} and t_{SD} .

AC Switching Characteristics Over the Operating Range (continued)^[4]

Parameter	Description	-10		-12		-15		Unit
		Min.	Max.	Min.	Max.	Min.	Max.	
t_{SCE}	\overline{CE} LOW to Write End	7		8		10		ns
t_{AW}	Address Set-up to Write End	7		8		10		ns
t_{HA}	Address Hold from Write End	0		0		0		ns
t_{SA}	Address Set-up to Write Start	0		0		0		ns
t_{PWE}	\overline{WE} Pulse Width	7		8		10		ns
t_{SD}	Data Set-up to Write End	5		6		7		ns
t_{HD}	Data Hold from Write End	0		0		0		ns
t_{LZWE}	\overline{WE} HIGH to Low-Z ^[7]	3		3		3		ns
t_{HZWE}	\overline{WE} LOW to High-Z ^[6, 7]		5		6		7	ns
t_{BW}	Byte Enable to End of Write	7		8		10		ns

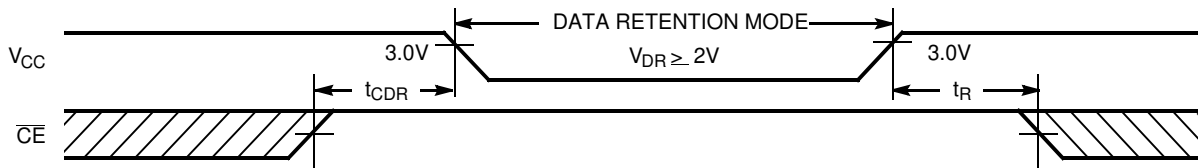
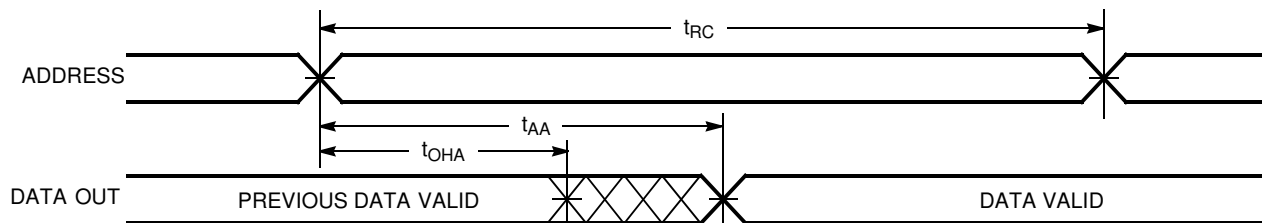
Data Retention Waveform

Switching Waveforms
Read Cycle No. 1^[10, 11]

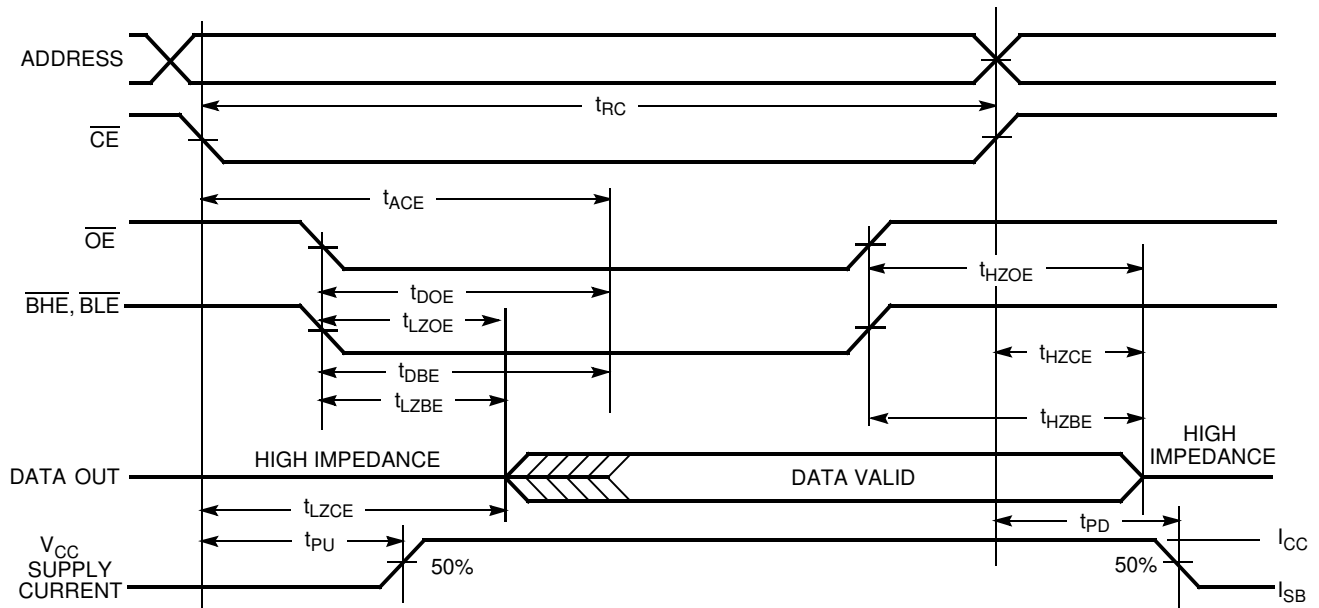
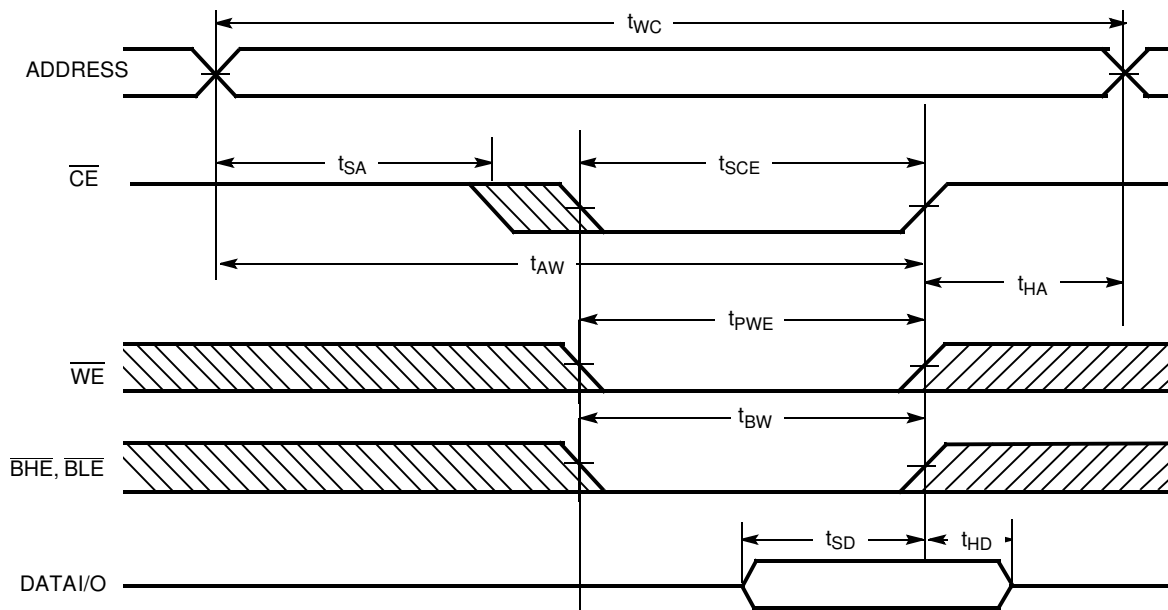
Notes:

10. Device is continuously selected. \overline{OE} , \overline{CE} , \overline{BHE} and/or $\overline{BHE} = V_{IL}$.
 11. \overline{WE} is HIGH for read cycle.

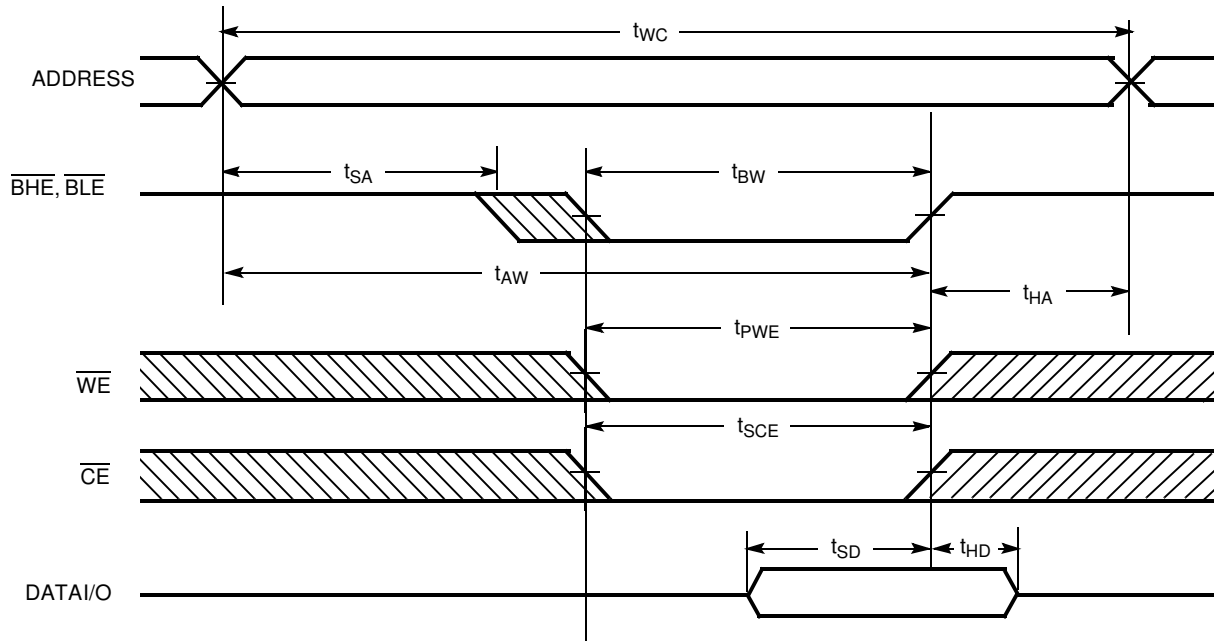
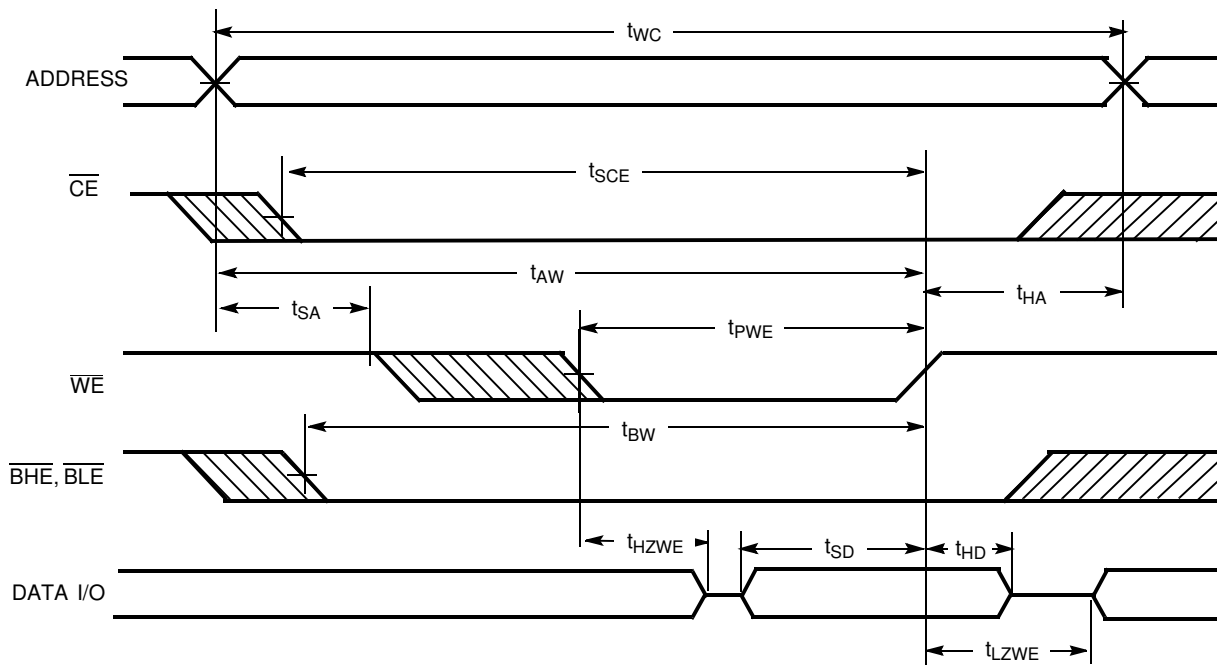
Switching Waveforms (continued)
Read Cycle No. 2 (\overline{OE} Controlled)^[11, 12]

Write Cycle No. 1 (\overline{CE} Controlled)^[13, 14]

Notes:

12. Address valid prior to or coincident with \overline{CE} transition LOW.
13. Data I/O is high-impedance if \overline{OE} or BHE and/or BLE = V_{IH} .
14. If \overline{CE} goes HIGH simultaneously with \overline{WE} going HIGH, the output remains in a high-impedance state.

Switching Waveforms (continued)
Write Cycle No. 2 ($\overline{\text{BLE}}$ or $\overline{\text{BHE}}$ Controlled)

Write Cycle No. 3 ($\overline{\text{WE}}$ Controlled, $\overline{\text{OE}}$ LOW)

Truth Table

\overline{CE}	\overline{OE}	\overline{WE}	\overline{BLE}	\overline{BHE}	I/O ₀ -I/O ₇	I/O ₈ -I/O ₁₅	Mode	Power
H	X	X	X	X	High-Z	High-Z	Power-down	Standby (I _{SB})
L	L	H	L	L	Data Out	Data Out	Read All Bits	Active (I _{CC})
L	L	H	L	H	Data Out	High-Z	Read Lower Bits Only	Active (I _{CC})
L	L	H	H	L	High-Z	Data Out	Read Upper Bits Only	Active (I _{CC})
L	X	L	L	L	Data In	Data In	Write All Bits	Active (I _{CC})
L	X	L	L	H	Data In	High-Z	Write Lower Bits Only	Active (I _{CC})
L	X	L	H	L	High-Z	Data In	Write Upper Bits Only	Active (I _{CC})
L	H	H	X	X	High-Z	High-Z	Selected, Outputs Disabled	Active (I _{CC})

Ordering Information

Speed (ns)	Ordering Code	Package Name	Package Type	Operating Range
10	CY7C1011CV33-10ZC	Z44	44-pin TSOP II	Commercial
	CY7C1011CV33-10ZXC	Z44	44-pin TSOP II (Pb-Free)	Commercial
	CY7C1011CV33-10ZXI	Z44	44-pin TSOP II (Pb-Free)	Industrial
	CY7C1011CV33-10ZI	Z44	44-pin TSOP II	Industrial
	CY7C1011CV33-10BVC	BV48A	48-ball VFBGA	Commercial
	CY7C1011CV33-10BVI	BV48A	48-ball VFBGA	Industrial
12	CY7C1011CV33-12ZC	Z44	44-pin TSOP II	Commercial
	CY7C1011CV33-12ZXC	Z44	44-pin TSOP II (Pb-Free)	Commercial
	CY7C1011CV33-12ZI	Z44	44-pin TSOP II	Industrial
	CY7C1011CV33-12ZXI	Z44	44-pin TSOP II (Pb-Free)	Industrial
	CY7C1011CV33-12AC	A44	44-pin TQFP	Commercial
	CY7C1011CV33-12AI	A44	44-pin TQFP	Industrial
	CY7C1011CV33-12AXI	A44	44-pin TQFP (Pb-Free)	Industrial
	CY7C1011CV33-12BVC	BV48A	48-ball VFBGA	Commercial
	CY7C1011CV33-12BVI	BV48A	48-ball VFBGA	Industrial
15	CY7C1011CV33-15ZC	Z44	44-pin TSOP II	Commercial
	CY7C1011CV33-15ZI	Z44	44-pin TSOP II	Industrial
	CY7C1011CV33-15ZXC	Z44	44-pin TSOP II (Pb-Free)	Commercial
	CY7C1011CV33-15AC	A44	44-pin TQFP	Commercial
	CY7C1011CV33-15AI	A44	44-pin TQFP	Industrial
	CY7C1011CV33-15AXI	A44	44-pin TQFP (Pb-Free)	Industrial
	CY7C1011CV33-15BVC	BV48A	48-ball VFBGA	Commercial
	CY7C1011CV33-15BVI	BV48A	48-ball VFBGA	Industrial

Package Diagrams

44-Pin TSOP II Z44

DIMENSION IN MM (INCH)
MAX
MIN

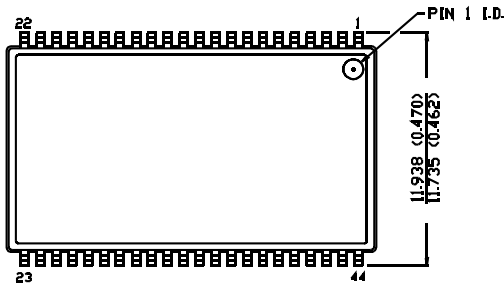

TOP VIEW

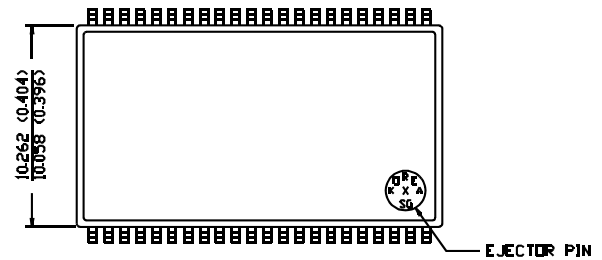

BOTTOM VIEW

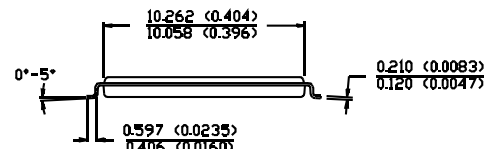
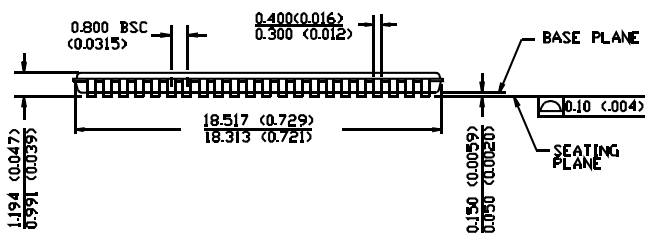

51-85087-A

44-Lead Thin Plastic Quad Flat Pack A44

DIMENSIONS ARE IN MILLIMETERS

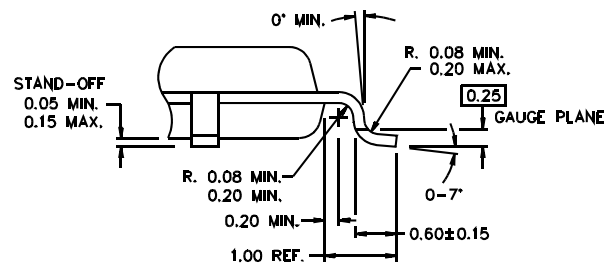
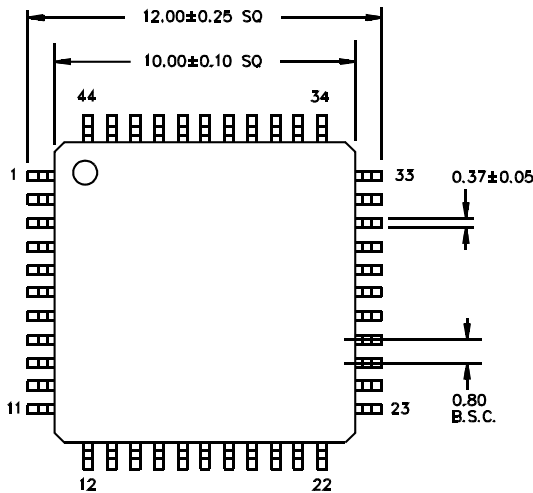

DETAIL A

51-85064-B

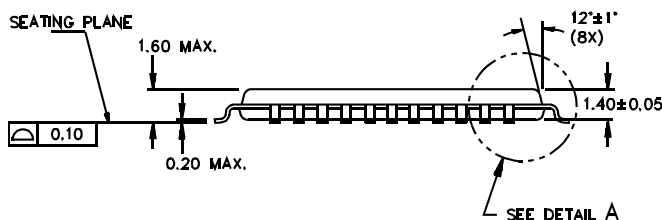

Package Diagrams (continued)

48-Lead VFBGA (6 x 8 x 1 mm) BV48A

TOP VIEW

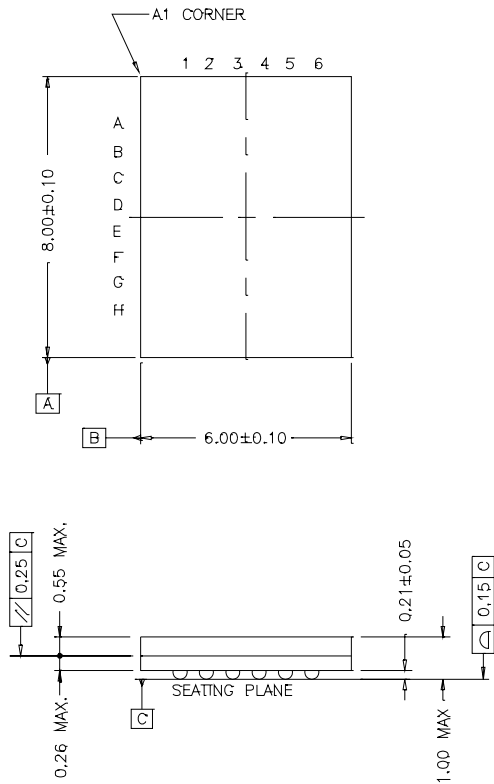

BOTTOM VIEW

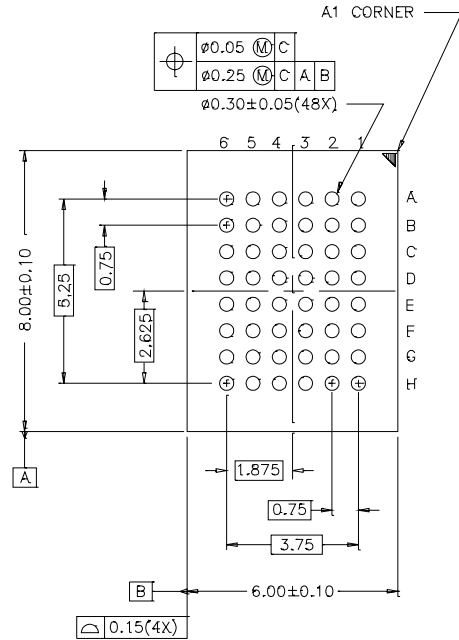

51-85150-B

All product and company names mentioned in this document are the trademarks of their respective holders.

Document History Page

Document Title: CY7C1011CV33 128K x 16 Static RAM				
Document Number: 38-05232				
REV.	ECN NO.	Issue Date	Orig. of Change	Description of Change
**	117132	07/31/02	HGK	New Data Sheet
*A	118057	08/19/02	HGK	Pin configuration for 48-ball FBGA correction
*B	119702	10/11/02	DFP	Updated FBGA to VFBGA; updated package code on page 8 to BV48A. Updated address pinouts on page 1 to A0 to A16. Updated CMOS standby current on page 1 from 8 to 10 mA.
*C	386106	See ECN	PCI	Added lead-free parts in Ordering Information Table