

Agilent WS2512

4 x 4 Power Amplifier Module for UMTS2100 (1920 – 1980 MHz)

Data Sheet

Description

The WS2512, a Wide-band Code Division Multiple Access (WCDMA) Power Amplifier (PA), is a fully matched 10-pin surface mount module developed for WCDMA handset applications. This power amplifier module operates in the 1920–1980 MHz bandwidth. The WS2512 meets the stringent WCDMA linearity requirements for output power of up to 28 dBm. A low current (V_{cont}) pin is provided for high efficiency improvement of the low output power range.

The WS2512 features CoolPAM Circuit technology offering state-of-the-art reliability, temperature stability and ruggedness.

The WS2512 is self contained, incorporating 50ohm input and output matching networks.

Features

- CoolPAM circuit technology
- Good linearity
- High efficiency
- 10-pin surface mounting package (4 mm x 4 mm x 1.4 mm)
- Low power-state control
- Low quiescent current
- Internal 50 Ω matching networks for both RF input and output

Applications

- W-CDMA handsets
- HSDPA handsets

Functional Block Diagram

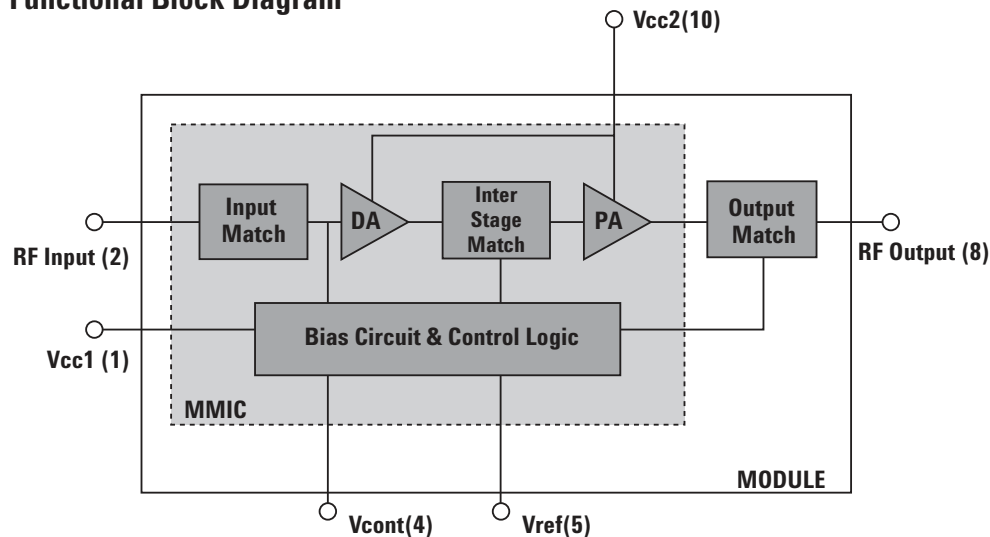

Table 1. Absolute Maximum Ratings^[1]

Parameter	Symbol	Min.	Typical	Max.	Unit
RF Input Power	P_{in}	–	–	10.0	dBm
DC Supply Voltage	V_{cc}	–	3.4	5.0	V
DC Reference Voltage	V_{ref}	–	2.85	3.3	V
Storage Temperature	T_{stg}	-55	–	+125	°C

Table 2. Recommended Operating Conditions

Parameter	Symbol	Min.	Typical	Max.	Unit
DC Supply Voltage					
– Mid/High Power Mode	V_{cc}	3.2	3.4	4.2	V
– Low Power Mode			1.5		V
DC Reference Voltage	V_{ref}	2.75	2.85	2.95	V
Mode Control Voltage					
– High Power Mode	V_{cont}	–	0	–	V
– Low/Mid Power Mode	V_{cont}	–	2.85	–	V
Operating Frequency	F_o	1920		1980	MHz
Ambient Temperature	T_a	-20	25	90	°C

Table 3. Power Range Truth Table

Power Mode	Symbol	Vref	Vcont ^[2]	Vcc	Range
High Power Mode ^[3]	PR3	2.85	Low	3.4	~28 dBm
Mid Power Mode ^[3]	PR2	2.85	High	3.4	~16 dBm
Low Power Mode ^[3]	PR1	2.85	High	1.5	~7 dBm
Shut Down Mode ^[4]	–	0.00	–	3.4	–

Notes:

1. No damage assuming only one parameter is set at limit at a time with all other parameters set at or below nominal value
2. High (1.5V – 3.0V), Low (0.0V – 0.5V).
3. To change between High Power Mode and Low Power Mode, switch Vcont accordingly.
4. In order to shut down the module, turn off Vref accordingly.

Table 4. Electrical Characteristics for WCDMA Mode (Vref=2.85V, Vcc=3.4V, Temp=+25°C)^[1]

Characteristics	Symbol	Condition	Min.	Typ.	Max.	Unit	
Operating Frequency Range	F		1920	–	1980	MHz	
Gain	Gain_hiw ^[2]	High Power Mode, Pout=28.0 dBm	23.5	26.5		dB	
	Gain_hi	High Power Mode, Pout=27.0 dBm	23.5	26.5		dB	
	Gain_mid	Mid Power Mode, Pout=16.0 dBm	14.5	17.5		dB	
	Gain_low	Low Power Mode, Pout=7.0 dBm, Vcc=1.5V	10	13.0		dB	
Power Added Efficiency	PAE_hiw ^[2]	High Power Mode, Pout=28.0 dBm	36	40		%	
	PAE_hi	High Power Mode, Pout=27.0 dBm	33	37		%	
	PAE_mid	Mid Power Mode, Pout=16.0 dBm	16.4	21.5		%	
	PAE_low	Low Power Mode, Pout=7.0 dBm, Vcc=1.5V	10.3	14		%	
Total Supply Current	Icc_hiw ^[2]	High Power Mode, Pout=28.0 dBm		465	510	mA	
	Icc_hi	High Power Mode, Pout=27.0 dBm		400	445	mA	
	Icc_mid	Mid Power Mode, Pout=16.0 dBm		54	70	mA	
	Icc_low	Low Power Mode, Pout=7.0 dBm, Vcc=1.5V		22	33	mA	
Quiescent Current	Iq_hi	High Power Mode	45	65	90	mA	
	Iq_mid	Mid Power Mode	7	13	22	mA	
	Iq_low	Low Power Mode, Vcc=1.5V	5	11	18	mA	
Reference Current	Iref_hi	High Power Mode		3.5	7	mA	
	Iref_mid	Mid Power Mode		4	8	mA	
	Iref_low	Low Power Mode, Vcc=1.5V		4	8	mA	
Control Current ^[3]	Icont_mid	Mid Power Mode		0.18	1	mA	
	Icont_low	Low Power Mode, Vcc=1.5V		0.18	1	mA	
Total Current in Power-down mode	Ipd	Vref=0.0V		0.2	5	µA	
ACLR in High power mode ^[4]	5 MHz offset	ACLR1_hiw ^[2]	High Power Mode, Pout=28.0 dBm	–	-42	-37	dBc
	10 MHz offset	ACLR2_hiw ^[2]	High Power Mode, Pout=28.0 dBm	–	-55	-47	dBc
ACLR in High power mode ^[4]	5 MHz offset	ACLR1_hi	High Power Mode, Pout=27.0 dBm	–	-40	-37	dBc
	10 MHz offset	ACLR2_hi	High Power Mode, Pout=27.0 dBm	–	-54	-47	dBc
ACLR in Mid power mode ^[4]	5 MHz offset	ACLR1_mid	Mid Power Mode, Pout=16.0 dBm	–	-45	-37	dBc
	10 MHz offset	ACLR2_mid	Mid Power Mode, Pout=16.0 dBm	–	-57	-47	dBc
ACLR in Low power mode ^[4]	5 MHz offset	ACLR1_low	Low Power Mode, Pout=7.0 dBm, Vcc=1.5V	–	-41	-37	dBc
	10 MHz offset	ACLR2_low	Low Power Mode, Pout=7.0 dBm, Vcc=1.5V	–	-54	-47	dBc
Harmonic Suppression	Second	2f0	High Power Mode, Pout=28.0 dBm	–	-42	-30	dBc
	Third	3f0	High Power Mode, Pout=28.0 dBm	–	-64	-45	dBc
Input VSWR	VSWR		–	2:1	2.5:1		
Stability (Spurious Output)	S	VSWR 6:1, All phase	–	–	-60	dBc	
Noise Power in Rx Band	RxBN	High Power Mode, Pout=28.0 dBm	–	-139	-136	dBm/Hz	

Notes:

1. Electrical characteristics are specified under HSDPA modulated Up-Link signal (DPCCH/DPDCH=12/15, HS-DPCCH/DPDCH=15/15) unless specified otherwise.
2. Specified under WCDMA modulated (3GPP Uplink DPCCH + 1DPDCH) signal.
3. Control current when series 6.2kohm is used.
4. ACP is expressed as a ratio of total adjacent power to signal power, both with 3.84 MHz bandwidth at specified offsets.

Table 4, continued. Electrical Characteristics* (Vref=2.85V, Vcc=3.4V, Temp=+25°C)^[2]

Characteristics		Symbol	Condition	Min.	Typ.	Max.	Unit
Ruggedness		Ru	Pout<28.0 dBm, Pin<10dBm, All phase	–	–	10:1	VSWR
Phase discontinuity		Ph mid_hi	Mid <-> Hi at Pout=16.0 dBm	–	7	25	Degree
		Ph low_mid	Low <-> Mid at Pout=7.0 dBm	–	15	25	Degree
Switching Time High ^[5]	DC	TswhighDC		–	20	–	µs
	RF	TswhighRF		–	1	–	µs
Switching Time Low ^[5]	DC	TswlowDC		–	20	–	µs
	RF	TswlowRF		–	1	–	µs
Turn On Time ^[6]	DC	TonDC		–	20	–	µs
	RF	TonRF		–	1	–	µs
Turn Off Time ^[6]	DC	ToffDC		–	20	–	µs
	RF	ToffDC		–	1	–	µs

Notes:

5. TswhighDC, TswlowDC is time required to reach stable quiescent bias(10%) after Vcont is switched low and high, respectively. TswhighRF, TswlowRF is time required to reach final output power (±1dB) after Vcont is switched low and high, respectively. TonDC is time required to reach stable quiescent bias (10%) after Vref is switched high.
6. ToffDC is time required for the current to be less than 10% of the Iq after Vref is switched low. TonRF is time required to reach final output power (±1dB) after Vref is switched high. ToffRF is time required to output power to drop 30dB after Vref is switched low.

Characteristics Data (HSDPA, Control scheme: 3-mode control, Vcc = 3.4V, Vref = 2.85V, T = 25°C, Fo = 1950 MHz)

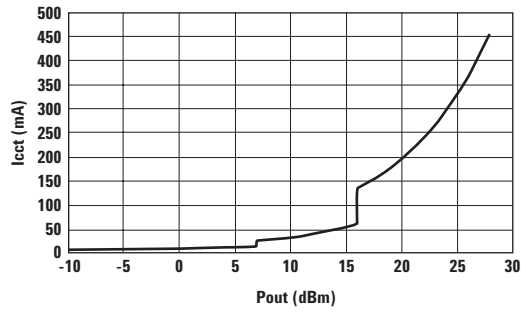

Figure 1. Total Current vs. Output Power.

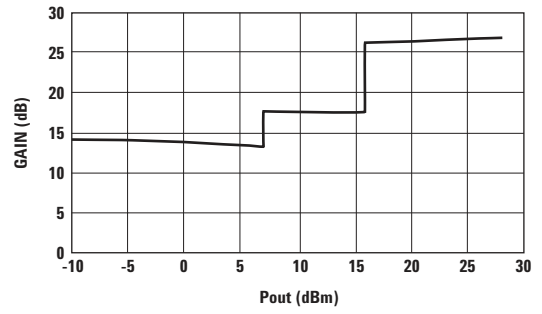

Figure 2. Gain vs. Output Power.

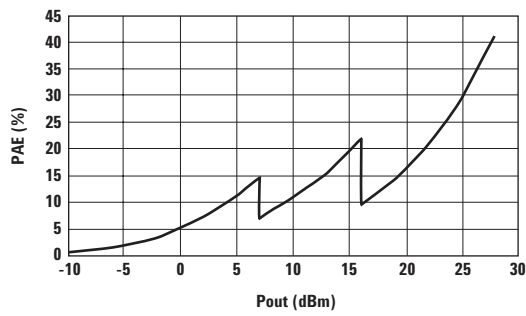

Figure 3. Power Added Efficiency vs. Output Power.

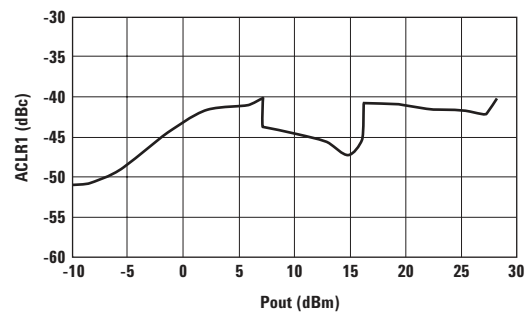

Figure 4. Adjacent Channel Leakage Ratio 1 vs. Output Power.

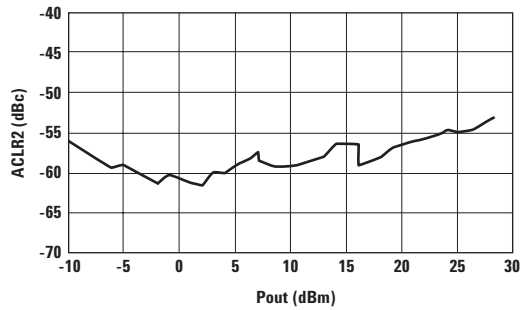

Figure 5. Adjacent Channel Leakage Ratio 2 vs. Output Power.

Characteristics Data (WCDMA, Control scheme: 3-mode control, $V_{cc} = 3.4V$, $V_{ref} = 2.85V$, $T = 25^{\circ}C$, $F_o = 1950$ MHz)

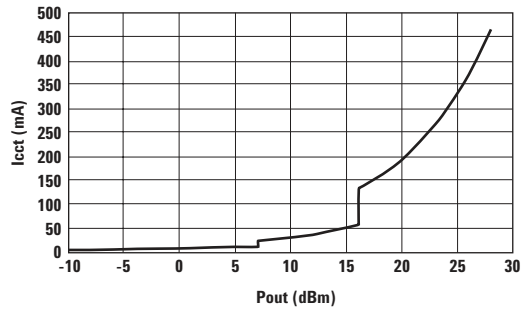

Figure 6. Total Current vs. Output Power.

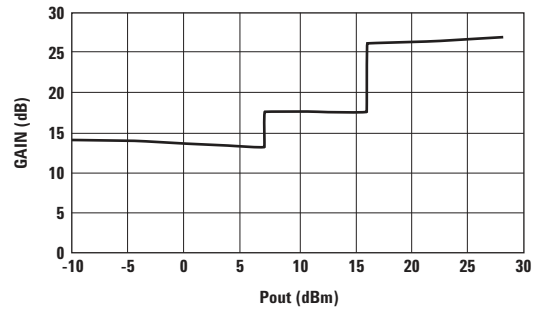

Figure 7. Gain vs. Output Power.

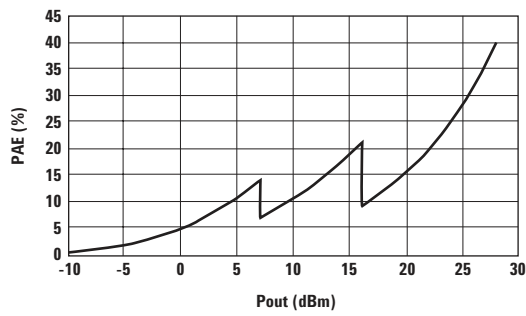

Figure 8. Power Added Efficiency vs. Output Power.

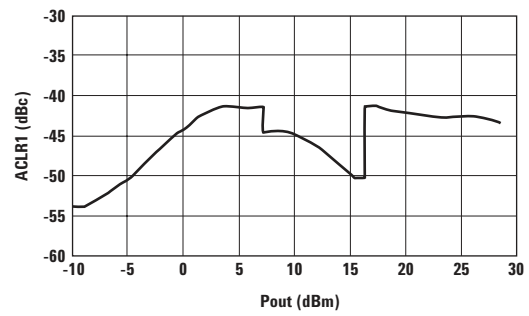

Figure 9. Adjacent Channel Leakage Ratio 1 vs. Output Power.

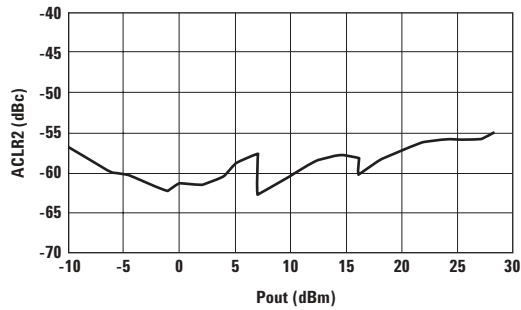

Figure 10. Adjacent Channel Leakage Ratio 2 vs. Output Power.

Characteristics Data (WCDMA, Control scheme: 2-mode control, $V_{cc} = 3.4V$, $V_{ref} = 2.85V$, $T = 25^{\circ}C$, $F_o = 1950\text{ MHz}$)

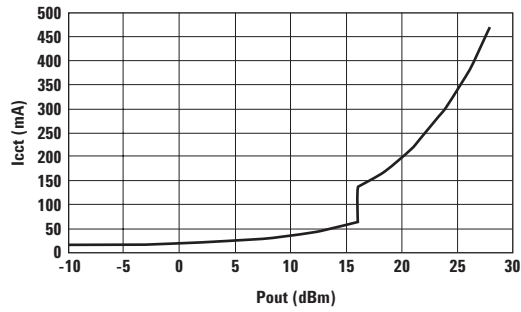

Figure 11. Total Current vs. Output Power.

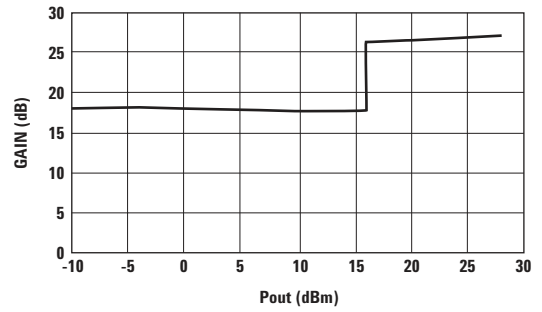

Figure 12. Gain vs. Output Power.

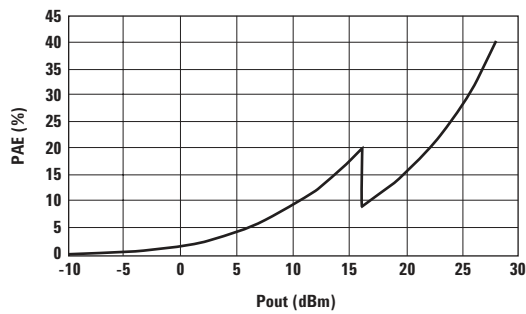

Figure 13. Power Added Efficiency vs. Output Power.

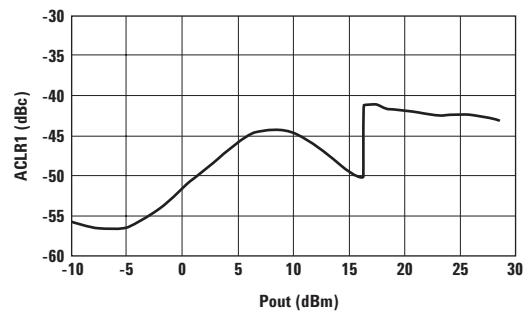

Figure 14. Adjacent Channel Leakage Ratio 1 vs. Output Power.

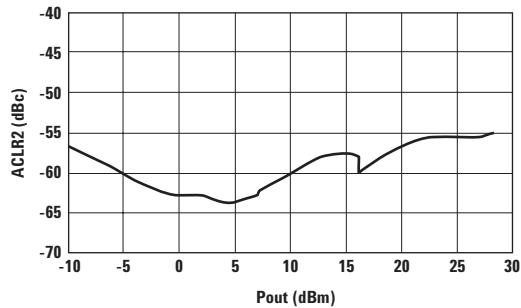

Figure 15. Adjacent Channel Leakage Ratio 2 vs. Output Power.

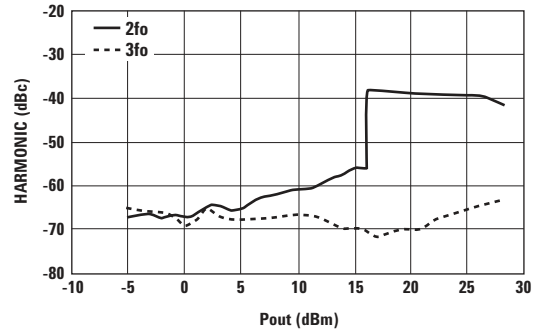

Figure 16. Harmonic Suppression 2 vs. Output Power.

Evaluation Board Description

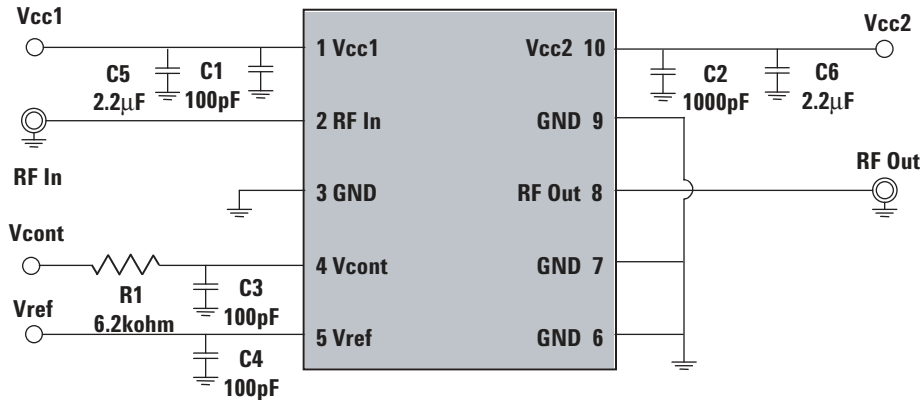

Figure 17. Evaluation Board Schematic.

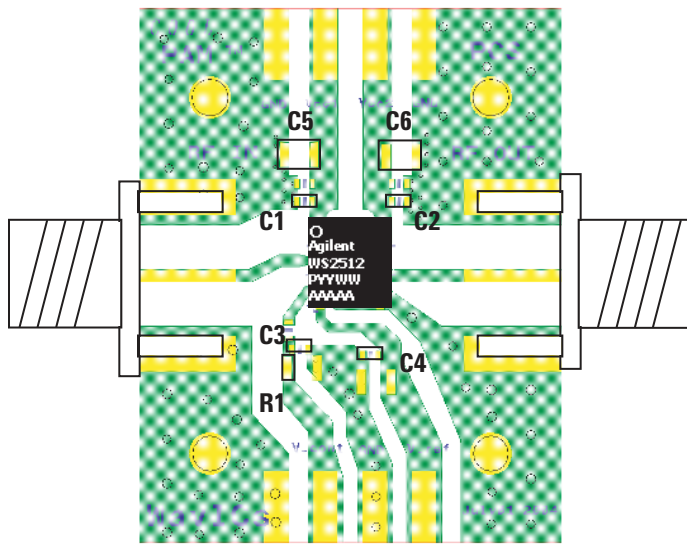
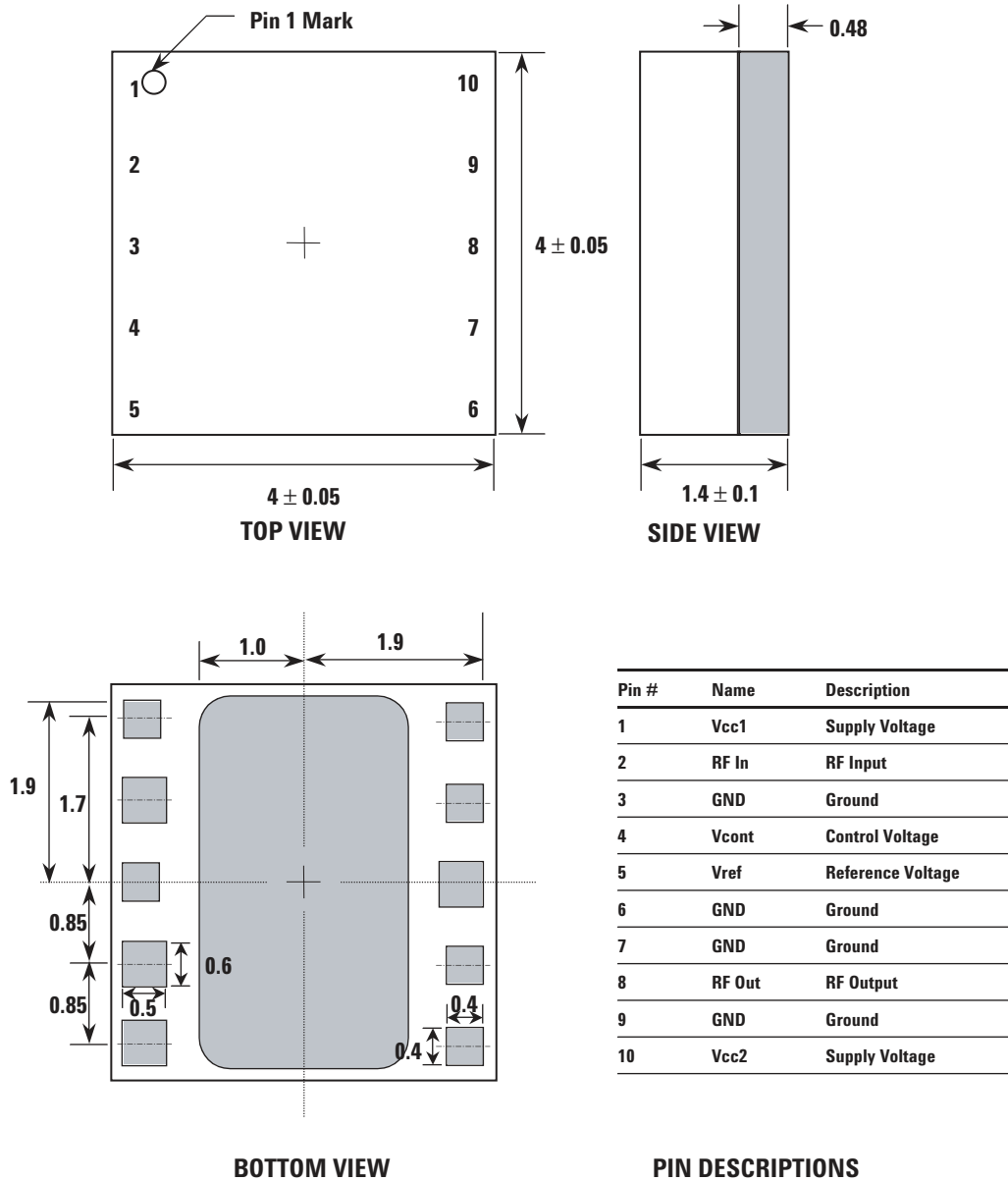

Figure 18. Evaluation Board Assembly Diagram.

Package Dimensions and Pin Descriptions



all dimensions are in millimeters

Figure 19. Package Dimensional Drawing and Pin Descriptions.

Package Dimensions and Pin Descriptions, continued

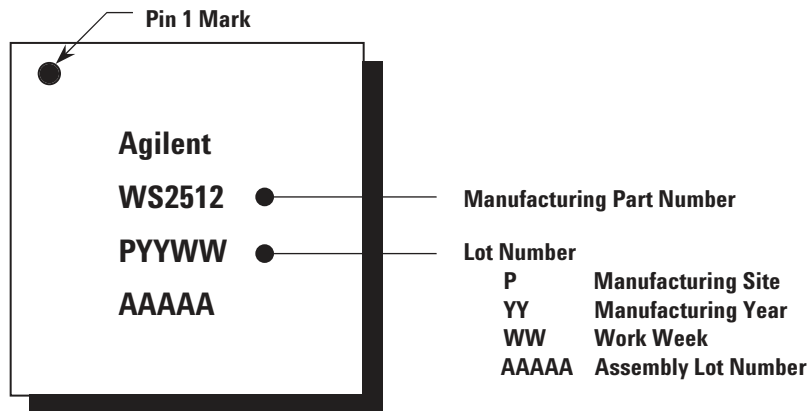

Figure 20. Marking Specification.

Peripheral Circuit in Handset

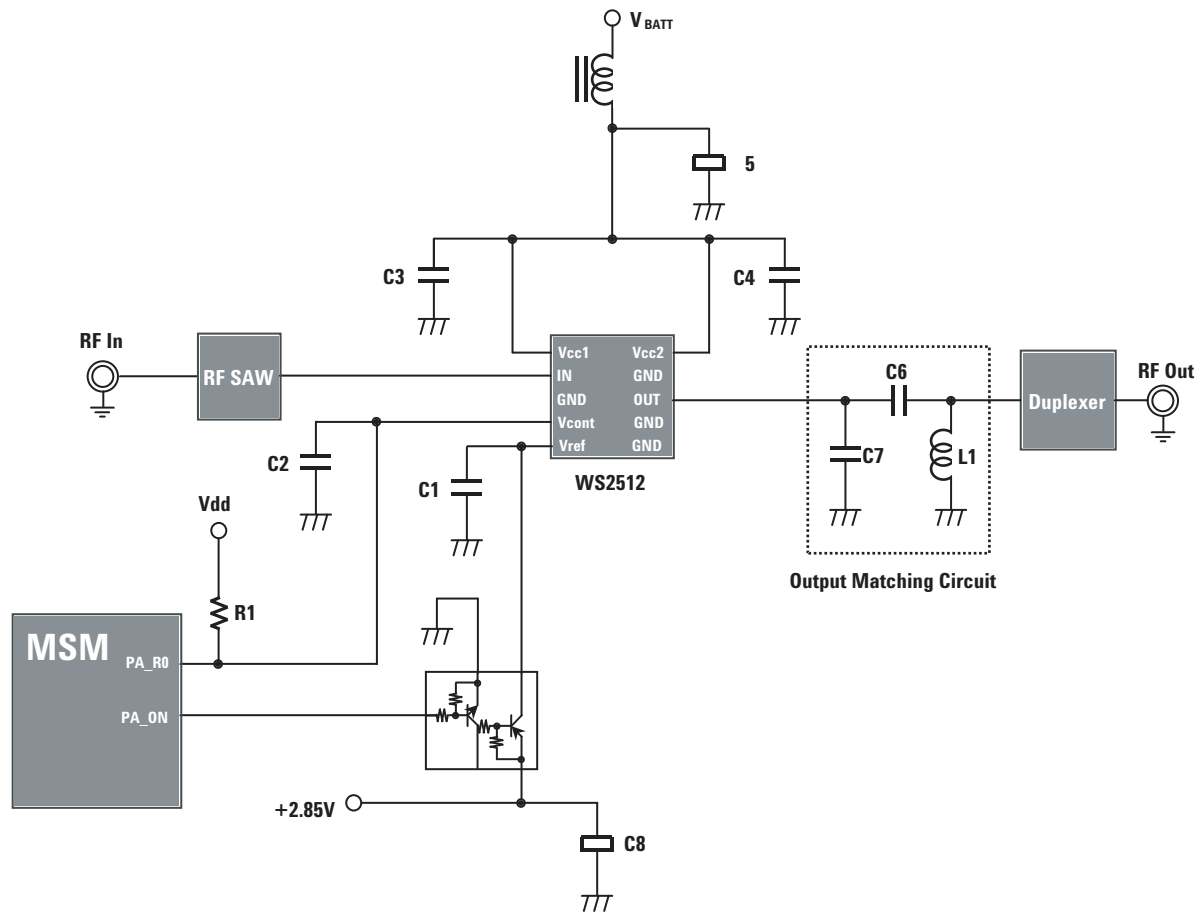

Figure 21. Peripheral Circuit.

Notes:

1. Recommended voltage for Vref is 2.85V.
2. Place C1 near to Vref pin.
3. Place C3 and C4 close to pin 1 (Vcc1) and pin 10 (Vcc2). These capacitors can affect the RF performance.
4. Use 50Ω transmission line between PAM and Duplexer and make it as short as possible to reduce conduction loss.
5. π -type circuit topology is good to use for matching circuit between PA and Duplexer.
6. Pull-up resistor (R1) should be used to limit current drain. 6.2 kohm is recommended for WS2512.

Calibration

Calibration procedure is shown in Figure 22. CoolPAM requires two calibration tables for high mode and low mode respectively. This is due to gain difference in each mode.

For continuous output power at the points of mode change, the input power should be adjusted according to gain step during the mode change.

Offset Value (difference between rising point and falling point)

Offset value, which is the difference between the rising point (output power where PA mode changes from low mode to high mode) and falling point (output power where PA mode changes from high mode to low mode), should be set to prevent system oscillation. 3 to 5 dB is recommended for Hysteresis.

Average Current & Talk Time

Probability Distribution Function implies that what is important for longer talk time is the efficiency of low or medium power range rather than the efficiency at full power. WS2512 idle current is 13 mA and operating current at 16 dBm is 54 mA at nominal condition. Average current calculated with CDMA PDF is 26 mA in urban area and 43 mA in suburban area for 2-mode control. Average current can be reduced with 3-mode control, which results in 20 mA in urban area and 38 mA in suburban area. This PA with low current consumption prolongs talk time by no less than 30 minutes compared to other PAs.

$$\text{Average current} = \int (\text{PDF} \times \text{Current}) dp$$

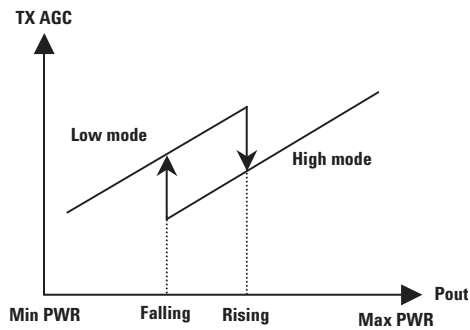

Figure 22. Calibration procedure.

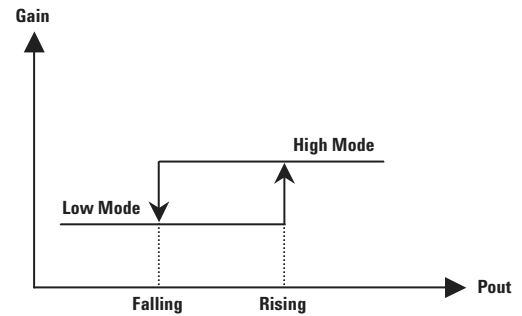

Figure 23. Setting of offset between rising and falling power.

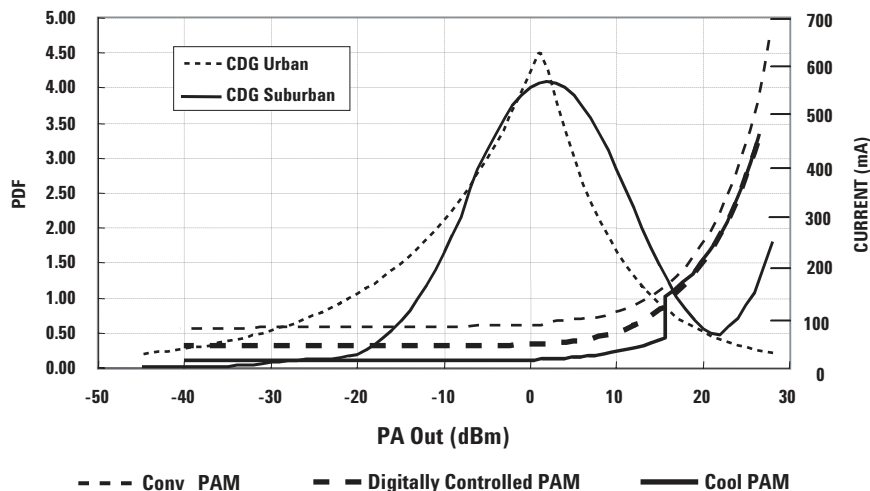

Figure 24. CDMA Power Distribution Function.

PCB Design Guidelines

The recommended WS2512 PCB Land pattern is shown in Figure 25 and Figure 26. The substrate is coated with solder mask between the I/O and conductive paddle to protect the gold pads from short circuit that is caused by solder bleeding/bridging.

Stencil Design Guidelines

A properly designed solder screen or stencil is required to ensure optimum amount of solder paste is deposited onto the PCB pads.

The recommended stencil layout is shown in Figure 27. Reducing the stencil opening can potentially generate more voids. On the other hand, stencil openings larger than 100% will lead to excessive solder paste smear or bridging across the I/O pads or conductive paddle to adjacent I/O pads. Considering the fact that solder paste thickness will directly affect the quality of the solder joint, a good choice is to use laser cut stencil composed of 0.100 mm (4mils) or 0.127 mm (5mils) thick stainless steel which is capable of producing the required fine stencil outline.

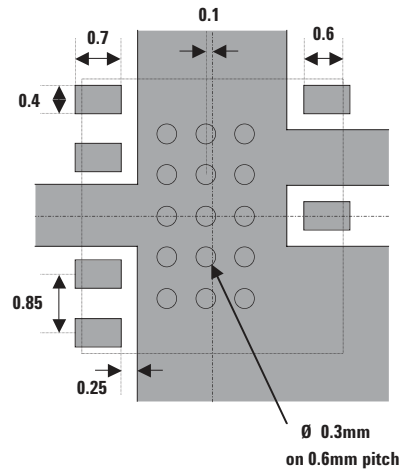

Figure 25. Metallization.

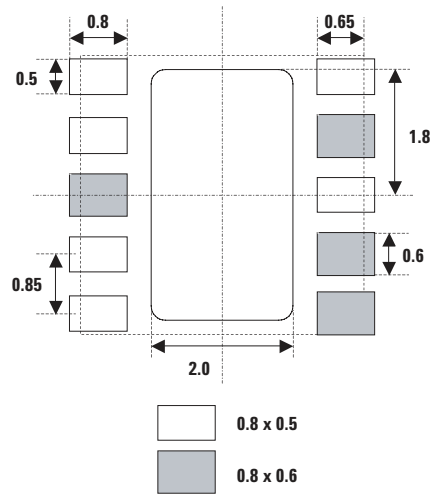

Figure 26. Solder Mask Opening.

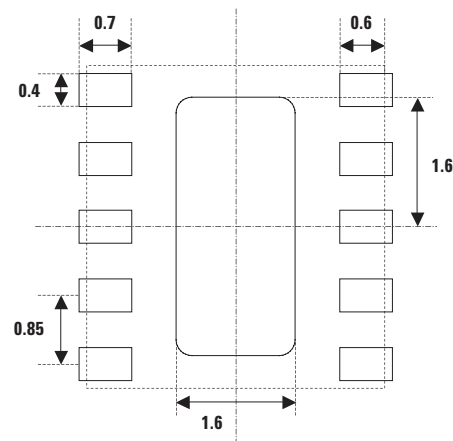

Figure 27. Solder Paste Stencil Aperature.

Power control scheme

- 2-mode control scheme

This control scheme doesn't require DC-DC converter. Vcont changes PA into Low Power Mode or High Power Mode, which results in 2-mode control without DC-DC converter. WS2512 is designed to change the mode at 16 dBm output power.

- 3-mode control scheme

This control scheme requires DC-DC converter. When DC-DC converter is used, Vcc voltage as well as Vcont can be changed, which results in 3-mode control scheme - Low/Mid/High power mode. Vcc changes at 7 dBm output and Vcont changes at 16 dBm output. Voltages for Vcc are 1.5V for low power mode and 3.4V(battery voltage) for mid and high power mode.

PAE graphs for 2-mode control and 3-mode control are shown in Figure 28 and Figure 29.

HSDPA

WS2512 meets stringent HSDPA linearity requirement up to 27 dBm. WS2512 can operate up to 28.5 dBm with Rel.99, which has a lower PAR (peak-to-average ratio) than HSDPA.

Table 5. Control scheme: 2-mode control

Power Mode	Vref	Vcont	Vcc	Power range
High Power Mode	2.85	Low	3.4	~28 dBm
Low Power Mode	2.85	High	3.4	~16 dBm
Shut Down Mode	0.00	–	3.4	–

Table 6. Control scheme: 3-mode control (DC-DC Converter Compatible)

Power Mode	Vref	Vcont	Vcc	Power range
High Power Mode	2.85	Low	3.4	~28 dBm
Middle Power Mode	2.85	High	3.4	~16 dBm
Low Power Mode	2.85	High	1.5	~7 dBm
Shut Down Mode	0.00	–	3.4	–

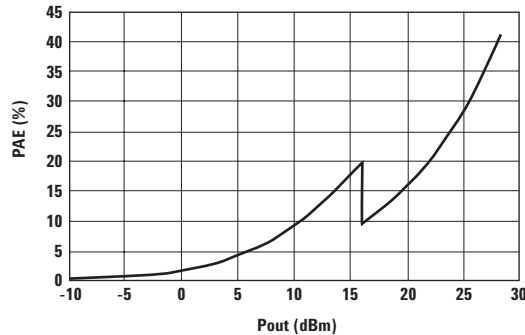

Figure 28. PAE (2-mode control).

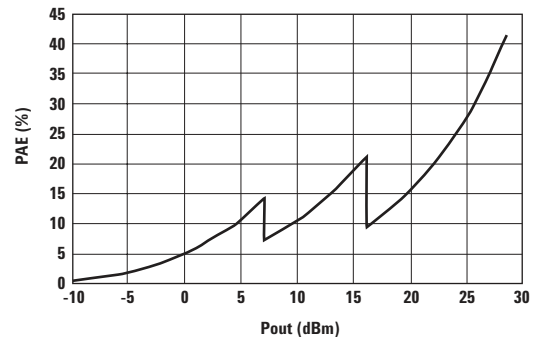
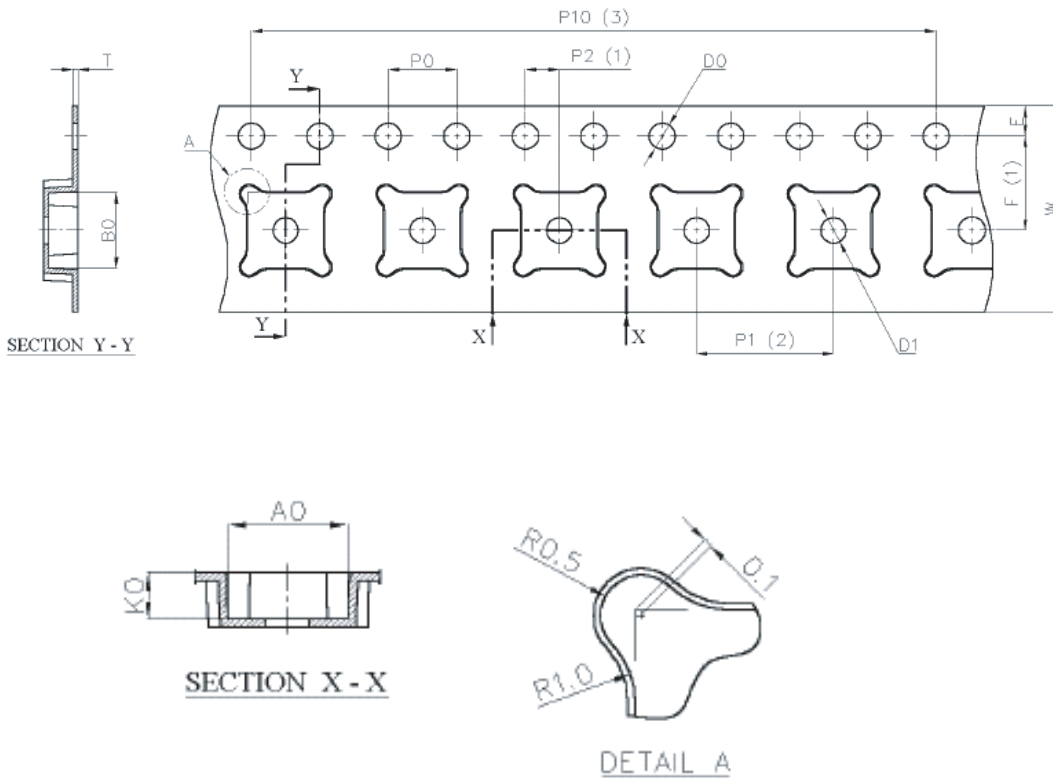

Figure 29. PAE (3-mode control).

Ordering Information

Part Number	Number of Devices	Container
WS2512-BLK	100	Bulk
WS2512-TR1	2500	13" Tape and Reel

Tape and Reel Information



Dimension List

Annote	Millimeter	Annote	Millimeter
A0	4.40 ±0.10	P2	2.00 ±0.05
B0	4.40 ±0.10	P10	40.00 ±0.20
K0	1.70 ±0.10	E	1.75 ±0.10
D0	1.55 ±0.05	F	5.50 ±0.05
D1	1.60 ±0.10	W	12.00 ±0.30
P0	4.00 ±0.10	T	0.30 ±0.05
P1	8.00 ±0.10		

Figure 30. Tape and Reel Format– 4 mm x 4 mm.

Tape and Reel Information, continued

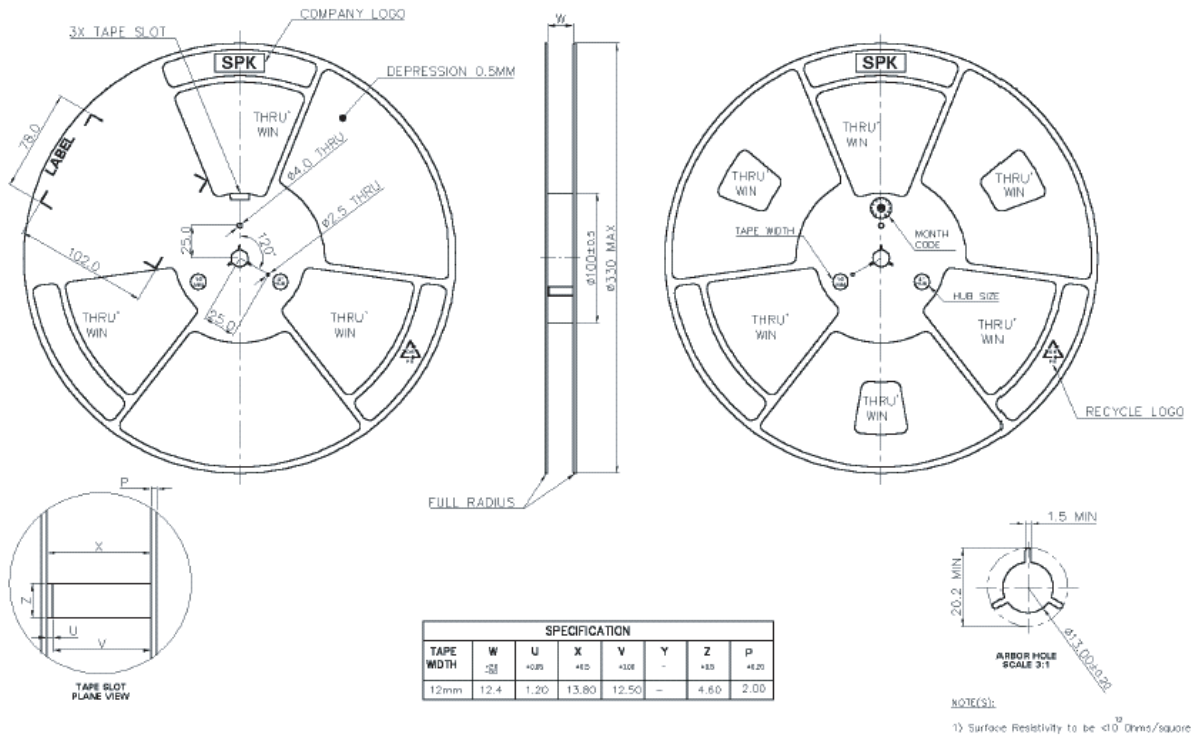

all dimensions are in millimeters

Figure 31. Plastic Reel Format–13"/14".

Handling and Storage

ESD (Electrostatic Discharge)

Electrostatic discharge occurs naturally in the environment. With the increase in voltage potential, the outlet of neutralization or discharge will be sought. If the acquired discharge route is through a semiconductor device, destructive damage will result.

ESD countermeasure methods should be developed and used to control potential ESD damage during handling in a factory environment at each manufacturing site.

MSL (Moisture Sensitivity Level)

Plastic encapsulated surface mount package is sensitive to damage induced by absorbed moisture and temperature. Agilent Technologies follows JEDEC Standard J-STD 020B. Each component and package type is classified for moisture sensitivity by soaking a known dry package at various temperatures and relative humidity, and times. After soak, the components are subjected to three consecutive simulated reflows.

The out of bag exposure time maximum limits are determined by the classification test

described below which corresponds to a MSL classification level 6 to 1 according to the JEDEC standard IPC/JEDEC J-STD-020B and J-STD-033.

WS2512 is MSL3. Thus, according to the J-STD-033 p.11 the maximum Manufacturers Exposure Time (MET) for this part is 168 hours. After this time period, the part would need to be removed from the reel, de-taped and then re-baked.

MSL classification reflow temperature for the WS2512 is targeted at 250°C +0/-5°C. Figure 32 and Table 9 show typical SMT profile for maximum temperature of 250+0/-5°C.

Table 7. ESD Classification

Pin#	Name	Description	HBM	CDM	Classification
1	Vcc1	Supply Voltage	± 2000V	± 200V	Class 2
2	RF In	RF Input	± 2000V	± 200V	Class 2
3	GND	Ground	± 2000V	± 200V	Class 2
4	Vcont	Control Voltage	± 2000V	± 200V	Class 2
5	Vref	Reference Voltage	± 2000V	± 200V	Class 2
6	GND	Ground	± 2000V	± 200V	Class 2
7	GND	Ground	± 2000V	± 200V	Class 2
8	RFOut	RF Output	± 2000V	± 200V	Class 2
9	GND	Ground	± 2000V	± 200V	Class 2
10	Vcc2	Supply Voltage	± 2000V	± 200V	Class 2

Note:

1. Module products should be considered extremely ESD sensitive.

Table 8. Moisture Classification Level and Floor Life

MSL Level	Floor Life (out of bag) at factory ambient ≤ 30°C/60% RH or as stated
1	Unlimited at ≤ 30°C/85% RH
2	1 year
2a	4 weeks
3	168 hours
4	72 hours
5	48 hours
5a	24 hours
6	Mandatory bake before use. After bake, must be reflowed within the time limit specified on the label

Note:

1. The MSL Level is marked on the MSL Label on each shipping bag.

Handling and Storage, continued

Storage Conditions

Packages described in this document must be stored in sealed moisture barrier, anti-static bags. Shelf life in a sealed moisture barrier bag is 12 months at <40°C and 90% relative humidity (RH) J-STD-033 p.7.

Out-of-Bag Time Duration

After unpacking the device must be soldered to the PCB within 168 hours as listed in the J-STD-020B p.11 with factory conditions <30°C and 60% RH.

Baking

It is not necessary to re-bake the part if both conditions (storage conditions and out-of-bag conditions) have been satisfied. Baking must be done if at least one of the conditions above have not been satisfied. The baking conditions are 125°C for 12 hours J-STD-033 p.8.

CAUTION: Tape and reel materials typically cannot be baked at the temperature described above. If out-of-bag exposure time is exceeded, parts must be baked for a longer time at low temperatures, or the parts must be de-reeled, de-taped, re-baked and then put back on tape and reel. (See moisture sensitive warning label on each shipping bag for information of baking).

Board Rework

Component Removal, Rework and Remount

If a component is to be removed from the board, it is recom-

mended that localized heating be used and the maximum body temperatures of any surface mount component on the board not exceed 200°C. This method will minimize moisture related component damage. If any component temperature exceeds 200°C, the board must be baked dry per 4-2 prior to rework and/or component removal. Component temperatures **shall** be measured at the top center of the package body. Any SMD packages that have not exceeded their floor life can be exposed to a maximum body temperature as high as their specified maximum reflow temperature.

Removal for Failure Analysis

Not following the above requirements may cause moisture/reflow damage that could hinder or completely prevent the determination of the original failure mechanism.

Baking of Populated Boards

Some SMD packages and board materials are not able to withstand long duration bakes at 125°C. Examples of this are some FR-4 materials, which cannot withstand a 24 hr bake at 125°C. Batteries and electrolytic capacitors are also temperature sensitive. With component and board temperature restrictions in mind, choose a bake temperature from Table 4-1 in J-STD 033; then determine the appropriate bake duration based on the component to be removed. For additional considerations see IPC-7711 and IPC-7721.

Derating due to Factory Environmental Conditions

Factory floor life exposures for SMD packages removed from the dry bags will be a function of the ambient environmental conditions. A safe, yet conservative, handling approach is to expose the SMD packages only up to the maximum time limits for each moisture sensitivity level as shown in Table 8. This approach, however, does not work if the factory humidity or temperature are greater than the testing conditions of 30°C/60% RH. A solution for addressing this problem is to derate the exposure times based on the knowledge of moisture diffusion in the component packaging materials (ref. JESD22-A120). Recommended equivalent total floor life exposures can be estimated for a range of humidities and temperatures based on the nominal plastic thickness for each device. Table 10 lists equivalent derated floor lives for humidity's ranging from 20–90% RH for three temperatures, 20°C, 25°C, and 30°C. This table is applicable to SMDs molded with novolac, biphenyl or multifunctional epoxy mold compounds. The following assumptions were used in calculating Table 10:

1. Activation Energy for diffusion = 0.35eV (smallest known value).
2. For ≤60% RH, use Diffusivity = $0.121 \exp(-0.35\text{eV}/kT)$ mm²/s (this uses smallest known Diffusivity @ 30°C).
3. For >60% RH, use Diffusivity = $1.320 \exp(-0.35\text{eV}/kT)$ mm²/s (this uses largest known Diffusivity @ 30°C).

Handling and Storage, continued

Table 10. Recommended Equivalent Total Floor Life (days) @ 20°C, 25°C & 30°C For ICs with Novolac, Biphenyl and Multifunctional Epoxies (Reflow at same temperature at which the component was classified)

Package Type and Body Thickness	Moisture Sensitivity Level	Maximum Percent Relative Humidity											
		5%	10%	20%	30%	40%	50%	60%	70%	80%	90%		
Body Thickness ≥3.1 mm including PQFPs >84 pins, PLCCs (square) All MQFPs or All BGAs ≥1 mm	Level 2a	∞	∞	∞	60	41	33	28	10	7	6	30°C	
		∞	∞	∞	78	53	42	36	14	10	8	25°C	
		∞	∞	∞	103	69	57	47	19	13	10	20°C	
	Level 3	∞	∞	10	9	8	7	5	4	4	30°C		
		∞	∞	13	11	10	9	7	6	5	25°C		
		∞	∞	17	14	13	12	12	10	8	7	20°C	
	Level 4	∞	5	4	4	4	3	3	3	2	2	30°C	
		∞	6	5	5	5	5	4	3	3	3	25°C	
		∞	8	7	7	7	7	6	5	4	4	20°C	
	Level 5	∞	4	3	3	2	2	2	2	1	1	30°C	
		∞	5	5	4	4	3	3	2	2	2	25°C	
		∞	7	7	6	5	5	4	3	3	3	20°C	
	Level 5a	∞	2	1	1	1	1	1	1	1	1	30°C	
		∞	3	2	2	2	2	2	1	1	1	25°C	
		∞	5	4	3	3	3	2	2	2	2	20°C	
Body 2.1 mm ≤ Thickness <3.1 mm including PLCCs (rectangular) 18-32 pins SOICs (wide body) SOICs ≥20 pins, PQFPs ≤80 pins	Level 2a	∞	∞	∞	∞	86	39	28	4	3	2	30°C	
		∞	∞	∞	∞	148	51	37	6	4	3	25°C	
		∞	∞	∞	∞	∞	69	49	8	5	4	20°C	
	Level 3	∞	∞	19	12	9	8	7	3	2	2	30°C	
		∞	∞	25	15	12	10	9	5	3	3	25°C	
		∞	∞	32	19	15	13	12	7	5	4	20°C	
	Level 4	∞	7	5	4	4	3	3	2	2	1	30°C	
		∞	9	7	5	5	4	4	3	2	2	25°C	
		∞	11	9	7	6	6	5	4	3	3	20°C	
	Level 5	∞	4	3	3	2	2	2	1	1	1	30°C	
		∞	5	4	3	3	3	3	2	1	1	25°C	
		∞	6	5	5	4	4	4	3	3	2	20°C	
	Level 5a	∞	2	1	1	1	1	1	1	0.5	0.5	30°C	
		∞	2	2	2	2	2	2	1	1	1	25°C	
		∞	3	2	2	2	2	2	2	2	1	20°C	
Body Thickness <2.1 mm including SOICs <18 pins All TQFPs, TSOPs or all BGAs <1 mm body thickness	Level 2a	∞	∞	∞	∞	∞	∞	28	1	1	1	30°C	
		∞	∞	∞	∞	∞	∞	∞	∞	2	1	1	25°C
		∞	∞	∞	∞	∞	∞	∞	∞	∞	2	1	20°C
	Level 3	∞	∞	∞	∞	∞	11	7	1	1	1	30°C	
		∞	∞	∞	∞	∞	14	10	2	1	1	25°C	
		∞	∞	∞	∞	∞	20	13	2	2	1	20°C	
	Level 4	∞	∞	∞	9	5	4	3	1	1	1	30°C	
		∞	∞	∞	12	7	5	4	2	1	1	25°C	
		∞	∞	∞	17	9	7	6	2	2	1	20°C	
	Level 5	∞	∞	13	5	3	2	2	1	1	1	30°C	
		∞	∞	18	6	4	3	3	2	1	1	25°C	
		∞	∞	26	8	6	5	4	2	2	1	20°C	
	Level 5a	∞	10	3	2	1	1	1	1	1	0.5	30°C	
		∞	13	5	3	2	2	2	1	1	1	25°C	
		∞	18	6	4	3	2	2	2	2	1	20°C	

www.agilent.com/semiconductors

For product information and a complete list of distributors, please go to our web site.

For technical assistance call:

Americas/Canada: +1 (800) 235-0312 or (916) 788-6763

Europe: +49 (0) 6441 92460

China: 10800 650 0017

Hong Kong: (+65) 6756 2394

India, Australia, New Zealand: (+65) 6755 1939

Japan: (+81 3) 3335-8152(Domestic/International), or 0120-61-1280(Domestic Only)

Korea: (+65) 6755 1989

Singapore, Malaysia, Vietnam, Thailand, Philippines, Indonesia: (+65) 6755 2044

Taiwan: (+65) 6755 1843

Data subject to change.

Copyright © 2005 Agilent Technologies, Inc.

October 16, 2005

5989-2542EN



Agilent Technologies