

Harvatek Top View Chip LEDs Data Sheet B1A81UY--20C000313U1930

Official Product	HT Part No. B1A81UY--20C000313U1930			
Tentative Product	*****	*****		
Specifications are subject to changes for improvement without advance notice. Proprietary data, drawings, company confidential all rights reserved.		07/13/2022	Version	Page 1/14

DISCLAIMER.....3

LIFE SUPPORT POLICY3

PRODUCT SPECIFICATIONS4

ATTENTION: ELECTROSTATIC DISCHARGE (ESD) PROTECTION4

LABEL SPECIFICATIONS5

SPECIFICATIONS RANGE6

PRODUCT FEATURES7

ELECTRO-OPTICAL CHARACTERISTICS.....7

PACKAGE OUTLINE DIMENSION AND RECOMMENDED SOLDERING PATTERN FOR REFLOW

SOLDERING.....7

ABSOLUTE MAXIMUM RATINGS7

PRECAUTION FOR USE8

PACKAGING9

TAPE DIMENSION10

REEL DIMENSION.....10

PACKING.....11

DRY PACK.....11

BAKING.....12

PRECAUTIONS12

REFLOW SOLDERING12

REWORKING.....13

CLEANING.....13

CAUTIONS OF PICK AND PLACE13

REVISE HISTORY.....15

Official Product	HT Part No. B1A81UY--20C000313U1930		
Tentative Product	*****	*****	
Specifications are subject to changes for improvement without advance notice. Proprietary data, drawings, company confidential all rights reserved.		07/13/2022	Version Page 2/14

DISCLAIMER

HARVATEK reserves the right to make changes without further notice to any products herein to improve reliability, function or design. HARVATEK does not assume any liability arising out of the application or use of any product or circuit described herein; neither does it convey any license under its patent rights, nor the rights of others

Life Support Policy

HARVATEK's products are not authorized for use as critical components in life support devices or systems without the express written approval of the President of HARVATEK or HARVATEK INTERNATIONAL. As used herein:

1. Life support devices or systems are devices or systems which, (a) are intended for surgical implant into the body, or (b) support or sustain life, and (c) whose failure to perform when properly used in accordance with instructions for use provided in the labeling, can be reasonably expected to result in a significant injury of the user.
2. A critical component in any component of a life support device or system whose failure to perform can be reasonably expected to cause the failure of the life support device or system, or to affect its safety or effectiveness.

Official Product	HT Part No. B1A81UY--20C000313U1930			
Tentative Product	*****	*****		
Specifications are subject to changes for improvement without advance notice. Proprietary data, drawings, company confidential all rights reserved.		07/13/2022	Version	Page 3/14

Product Specifications

Item	Specification	Material	Quantity
Luminous Intensity(Iv)	345 mcd Typical @20 mA/ T _S = 25°C;Tolerance: ±10%		
Wavelength	586 nm Typical @20 mA/ T _S = 25°C;Tolerance: ±0.5nm		
Vf	2.0 V Typical @20 mA/ T _S = 25°C;Tolerance: ±0.05V		
Ir	< 100 μA @ V _R = 5 V		
Resin	Water clear	Epoxy	
Carrier tape	EIA 481-1A specs	Conductive black tape	
Reel	EIA 481-1A specs	Conductive black	
Label	HT standard	Paper	
Packing bag	250x230mm	Aluminum laminated bag/ no-zipper	One reel per bag
Carton	HT standard	Paper	Non-specified

Others:

Each immediate box consists of 5 reels. The 5 reels may not necessarily have the same lot number or the same bin combinations of Iv, CIE and Vf. Each reel has a label identifying its specification; the immediate box consists of a product label as well.

Note :This is shipped test conditions

※Remarks: This product should be operated in forward bias. If a reverse voltage is continuously applied to the product, such operation can cause migration resulting in LED damage.

ATTENTION: Electrostatic Discharge (ESD) protection



The symbol to the left denotes that ESD precaution is needed. ESD protection for GaP and AlGaAs based chips is necessary even though they are relatively safe in the presence of low static-electric discharge. Parts built with AlGaInP, GaN, or/and InGaN based chips are **STATIC SENSITIVE devices**. ESD precaution must be taken during design and assembly.

If manual work or processing is needed, please ensure the device is adequately protected from ESD during the process.

Official Product	HT Part No. B1A81UY--20C000313U1930			
Tentative Product	*****	*****		
Specifications are subject to changes for improvement without advance notice. Proprietary data, drawings, company confidential all rights reserved.		07/13/2022	Version	Page 4/14

Label Specifications



Harvatek P/N:

B 1A8 1 UY-- 20C- 0003 13

Product	Package	Dice Qty	Color	Current	Series Number	Taping
PCB	3.2(L)x1.6(W)x1.1(H) mm	1:Single	UY:Amber	20mA	0001~ZZZZ	1.Taping style 2. Qty

Lot No.:

1	2	3	4	5	6	7	8	9	10
E	1	A	1	A	2	2	L	1	2
Code 1 2		Code 3	Code 4	Code 5	Code 6	Code 7	Code 8	Code 9	Code 10
		Mfg. Year	Mfg. Month	Mfg. Date	Consecutive number		Special code		
Internal Tracing Code		2020-L 2021-M 2022-P 2023-Q ... 2026-T 2027-V ... 2030-Y 2031-Z ...	1:Jan. 2:Feb. ... A:Oct. B:Nov. C:Dec.	1:A 2:B 3:C ... 26:Z 27:7 28:8 29:9 30:3 31:4	01-ZZ		000-ZZZ		

Official Product	HT Part No. B1A81UY--20C000313U1930			
Tentative Product	*****	*****		
Specifications are subject to changes for improvement without advance notice. Proprietary data, drawings, company confidential all rights reserved.		07/13/2022	Version	Page 5/14

Specifications Range

■ Luminous Intensity (Iv) Bin:

Color	Bin Code	Spec. Range
UY	R	112.50-180.00 mcd
	S	180.00-285.00 mcd
	T	285.00-360.00 mcd
	U	360.00-450.00 mcd
	V	450.00-560.00 mcd

Note: It maintains a tolerance of $\pm 10\%$ on IV

■ Wavelength Bin:

Color	Bin Code	Spec. Range
UY	A	582.0-584.5 nm
	B	584.5-587.0 nm
	C	587.0-589.5 nm
	D	589.5-592.0 nm
	E	592.0-594.5 nm
	F	594.5-597.0 nm

Note: It maintains a tolerance of $\pm 0.5\text{nm}$ on Wavelength Bin

■ Forward Voltage (Vf) Bin:

Color	Bin Code	Spec. Range
UY	E1A	1.6-2.6 V

Note: It maintains a tolerance of $\pm 0.05\text{V}$ on forward voltage measurements

Official Product	HT Part No. B1A81UY--20C000313U1930			
Tentative Product	*****	*****	*****	*****
Specifications are subject to changes for improvement without advance notice. Proprietary data, drawings, company confidential all rights reserved.		07/13/2022	Version	Page 6/14

Product Features

Electro-Optical Characteristics

(T_{Soldering}, 25°C)

Series	Emitting Color	Material	V _F (V)		Wavelength λ(nm)			I _v (mcd)	Viewing Angle $2\theta_{\frac{1}{2}}$
			Typ.	max	λD	λP	Δλ	Typical	
B1A81	UY	AlGaInP	2.0	2.4	586	591	20	345	70

Package Outline Dimension and Recommended Soldering Pattern for Reflow Soldering

(Unit: mm Tolerance: +/-0.1)

Outline Dim.	Suggest Soldering Pattern
<p>Soldering terminals may shift in the x, y direction.</p>	

Absolute Maximum Ratings

(T_{Soldering} 25°C)

Series	P _D (mW)	I _F (mA)	I _{FP} (mA)*	T _{OP} (°C)	T _{ST} (°C)
Color	Power Dissipation	Forward Current	Pulse Forward Current	Operating Temperature	Storage Temperature
UY	52	40	60	-40~+85	-40~+100

* Condition for I_{FP} is pulse of 1/10 duty and 0.1msec width

Official Product	HT Part No. B1A81UY--20C000313U1930			
Tentative Product	*****	*****	*****	*****
Specifications are subject to changes for improvement without advance notice. Proprietary data, drawings, company confidential all rights reserved.		07/13/2022	Version	Page 7/14

Characteristics of B1A81

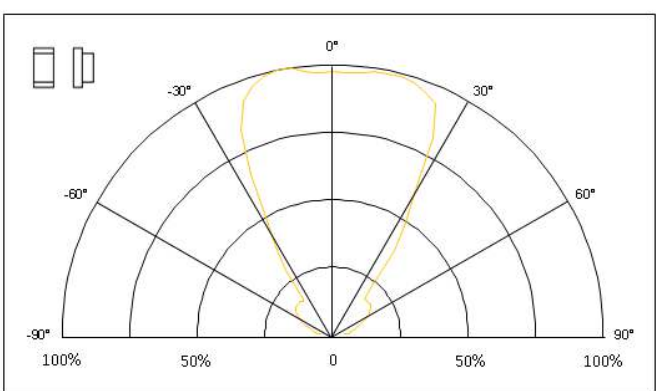
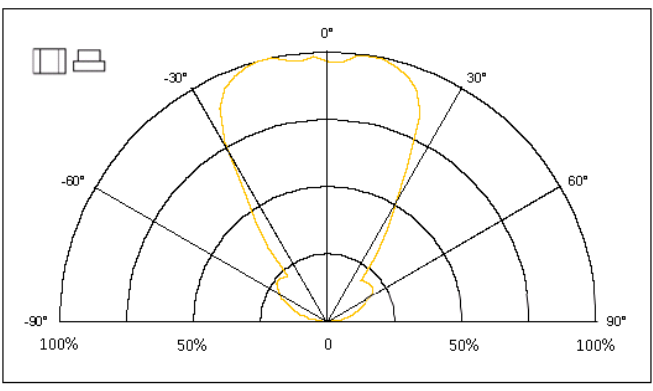
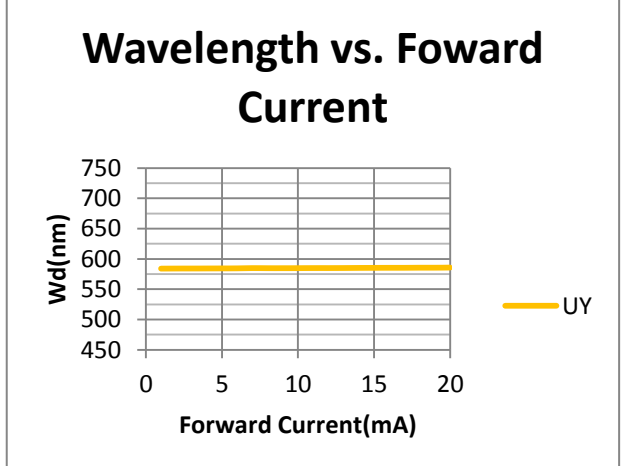
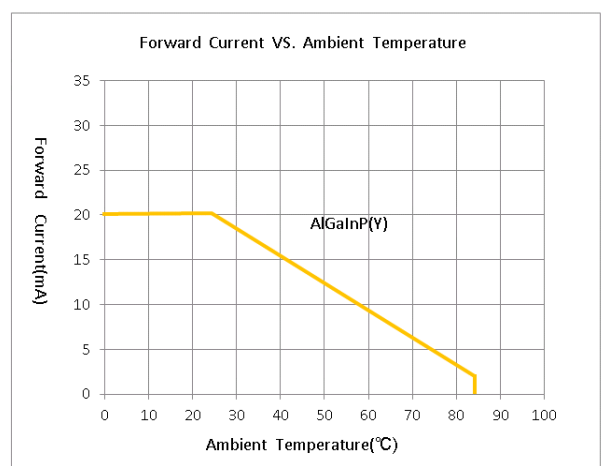
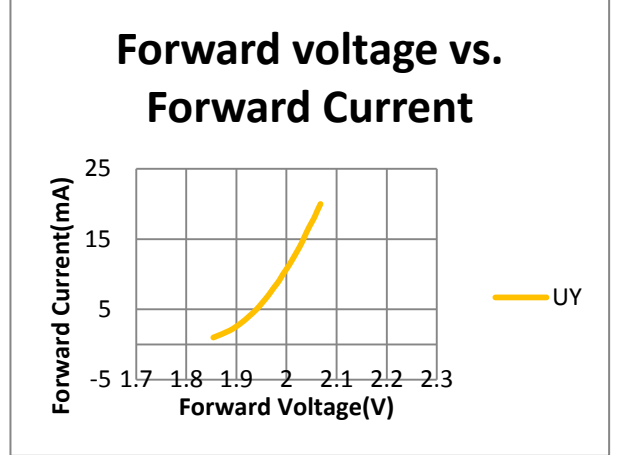
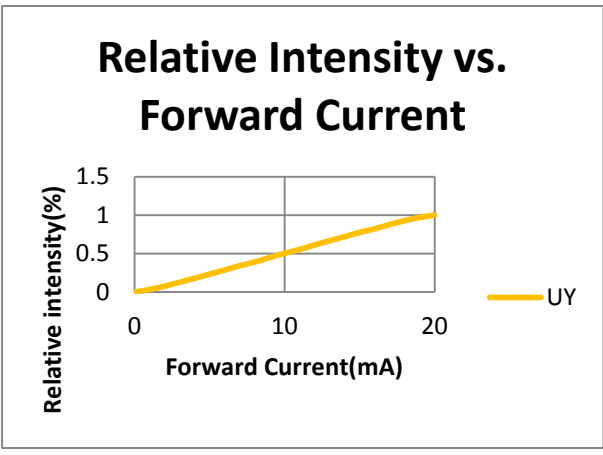

Precaution for Use

Official Product	HT Part No. B1A81UY--20C000313U1930		
Tentative Product	*****	*****	*****
Specifications are subject to changes for improvement without advance notice. Proprietary data, drawings, company confidential all rights reserved.	07/13/2022	Version	Page 8/14

1. The chips should not be used directly in any type of fluid such as water, oil, organic solvent, etc.
2. When the LEDs are illuminating, the maximum ambient temperature should be first considered before operation.
3. LEDs must be stored in a clean environment. A sealed container with a nitrogen atmosphere is necessary if the storage period is over 3 months after shipping.
4. The LEDs must be used within 4 weeks after unpacked. Unused products must be repacked in an anti-electrostatic package, folded to close any opening and then stored in a dry and cool space.
5. The appearance and specifications of the products may be modified for improvement without further notice.
6. The LEDs are sensitive to the static electricity and surge. It is strongly recommended to use a grounded wrist band and anti-electrostatic glove when handling the LEDs. If a voltage over the absolute maximum rating is applied to LEDs, it will damage LEDs. Damaged LEDs will show some abnormal characteristics such as remarkable increase of leak current, lower turn-on voltage and getting unlit at low current.

Packaging

Official Product	HT Part No. B1A81UY--20C000313U1930			
Tentative Product	*****	*****		
Specifications are subject to changes for improvement without advance notice. Proprietary data, drawings, company confidential all rights reserved.		07/13/2022	Version	Page 9/14

Tape Dimension

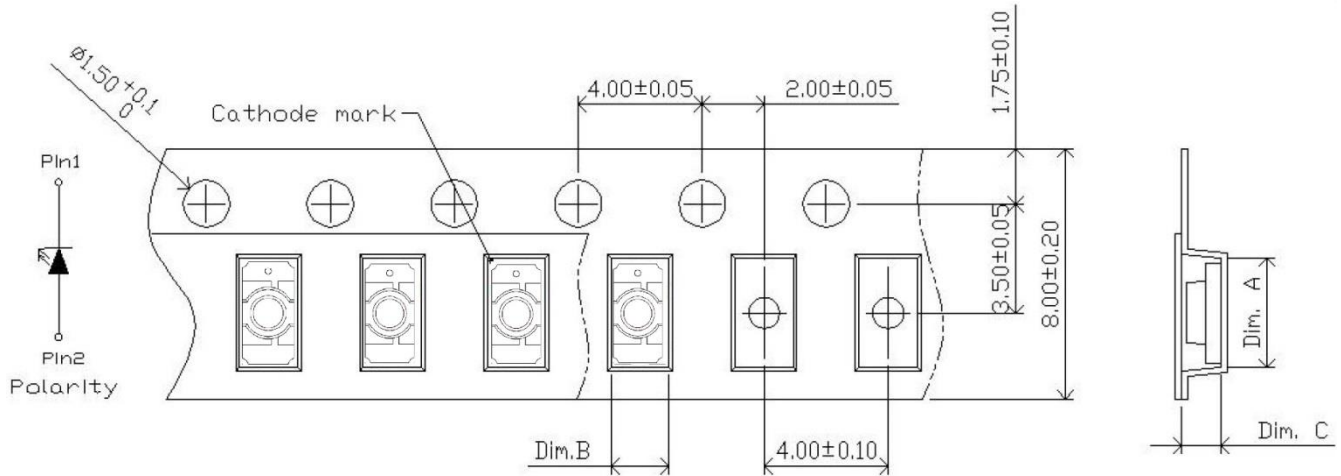

Dim. A	Dim. B	Dim. C	Qty/Reel
3.5±0.1	1.88±0.1	1.27±0.1	3000

Unit: mm

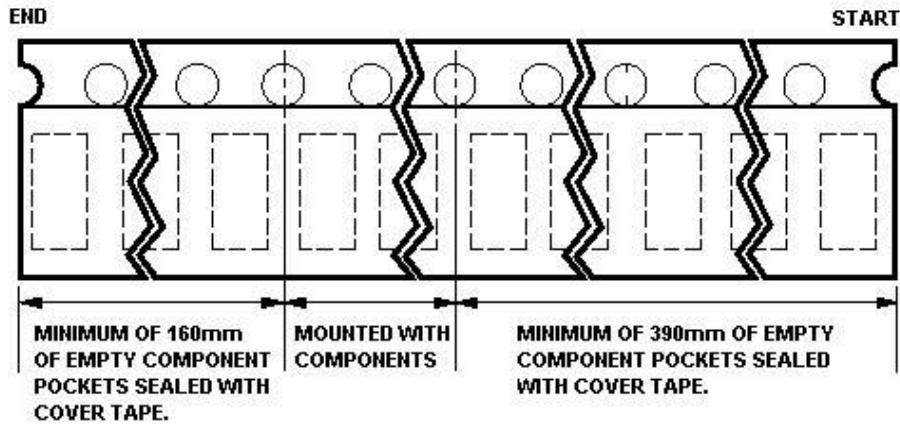

Reel Dimension

Official Product	HT Part No. B1A81UY--20C000313U1930		
Tentative Product	*****	*****	
Specifications are subject to changes for improvement without advance notice. Proprietary data, drawings, company confidential all rights reserved.		07/13/2022	Version Page 10/14

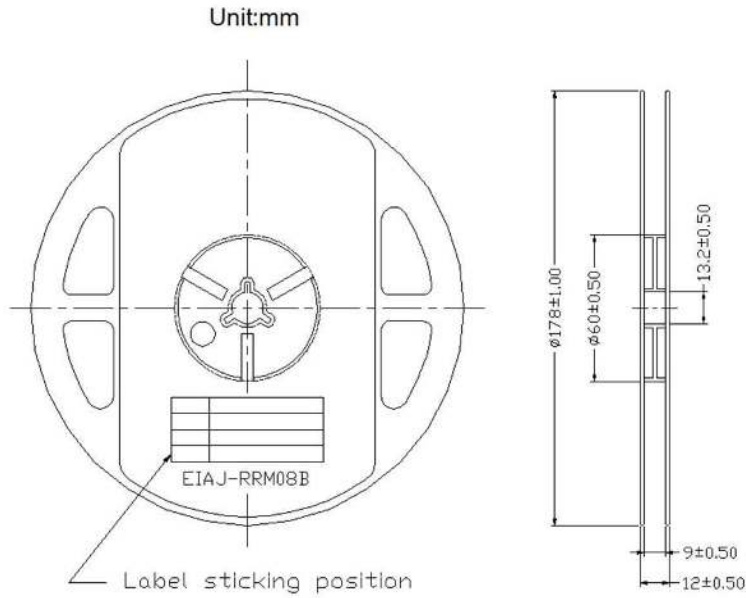

Packing

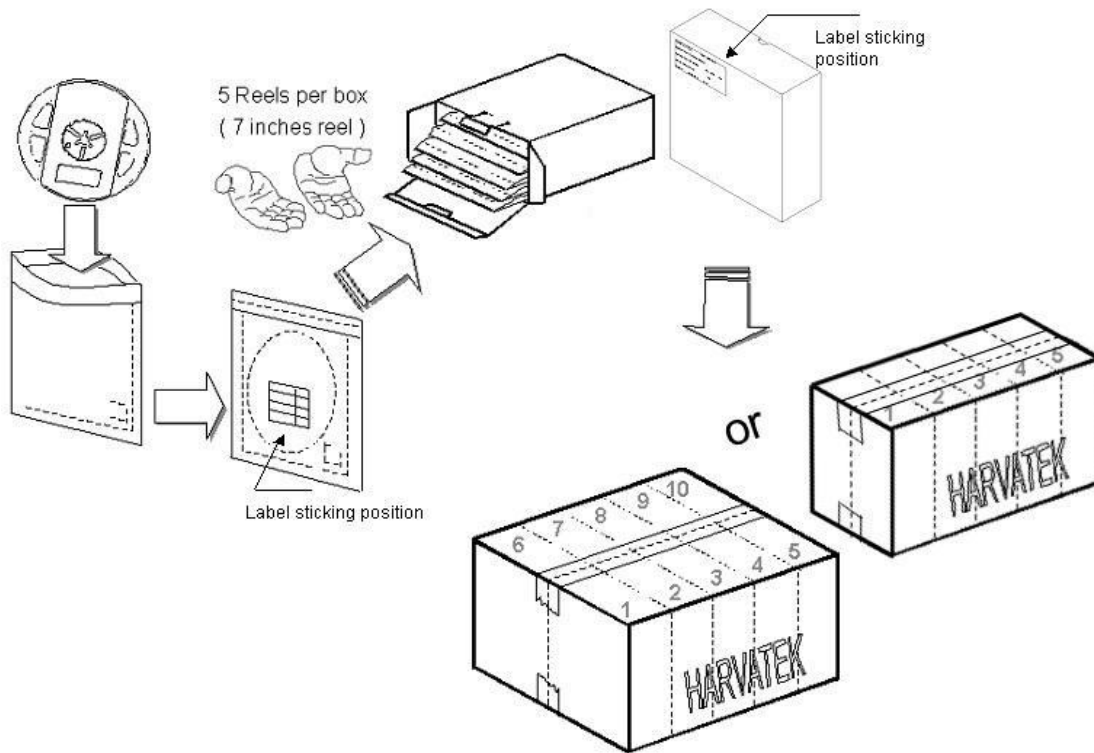

5 or 10 boxes per carton is available depending on shipment quantity.

Dry Pack

All SMD optical devices are **MOISTURE SENSITIVE**. Avoid exposure to moisture at all times

Official Product	HT Part No. B1A81UY--20C000313U1930		
Tentative Product	*****	*****	
Specifications are subject to changes for improvement without advance notice. Proprietary data, drawings, company confidential all rights reserved.	07/13/2022	Version	Page 11/14

during transportation or storage. Every reel is packaged in a moisture protected anti-static bag. Each bag is properly sealed prior to shipment.

Upon request, a humidity indicator will be included in the moisture protected anti-static bag prior to shipment.

The packaging sequence is as follows:

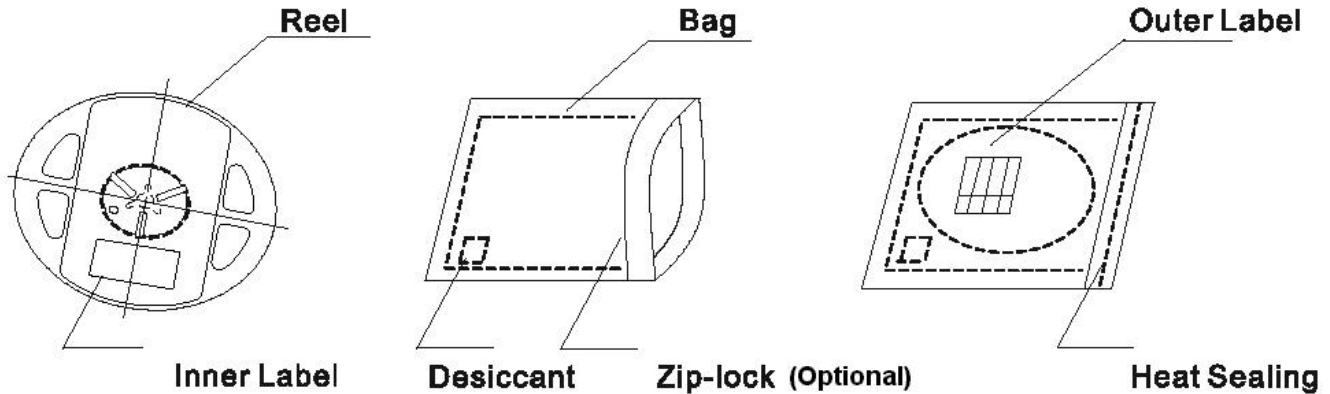

Baking

Baking before soldering is recommended when the package has been unsealed for 4 weeks.

The conditions are as followings:

1. $60\pm 3^{\circ}\text{C} \times (12\sim 24\text{hrs})$ and $<5\%RH$, taped reel type.
2. $100\pm 3^{\circ}\text{C} \times (45\text{min}\sim 1\text{hr})$, bulk type.
3. $130\pm 3^{\circ}\text{C} \times (15\text{min}\sim 30\text{min})$, bulk type.

Precautions

1. Avoid exposure to moisture at all times during transportation or storage.
2. Anti-Static precaution must be taken when handling GaN, InGaN, and AlGaInP products.
3. It is suggested to connect the unit with a current limiting resistor of the proper size. Avoid applying a reverse voltage beyond the specified limit.
4. Avoid operation beyond the limits as specified by the absolute maximum ratings.
5. Avoid direct contact with the surface through which the LED emits light.
6. If possible, assemble the unit in a clean room or dust-free environment.

Reflow Soldering

Recommend soldering paste specifications:

Official Product	HT Part No. B1A81UY--20C000313U1930			
Tentative Product	*****	*****		
Specifications are subject to changes for improvement without advance notice. Proprietary data, drawings, company confidential all rights reserved.		07/13/2022	Version	Page 12/14

1. Operating temp.: Above 217°C ,60~150 sec.
2. Peak temp.:260°C Max.,10sec Max.
3. Reflow soldering should not be done more than two times.
4. Never attempt next process until the component is cooled down to room temperature after reflow.
5. The recommended reflow soldering profile (measured on the surface of the LED terminal) is as following:

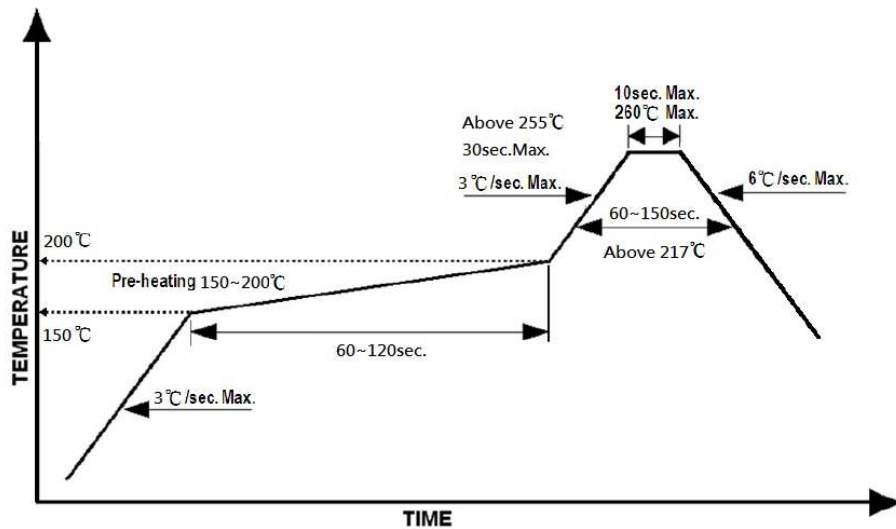

Reworking

- Rework should be completed within 5 seconds under 260°C.
- The iron tip must not come in contact with the copper foil.
- Twin-head type is preferred.

Cleaning

Following are cleaning procedures after soldering:

- An alcohol-based solvent such as isopropyl alcohol (IPA) is recommended.
- Temperature x Time should be 50°C x 30sec. or <30°C x 3min
- Ultrasonic cleaning: < 15W/ bath; bath volume ≤ 1liter
- Curing: 100 °C max, <3min

Cautions of Pick and Place

- Avoid stress on the resin at elevated temperature.

Official Product	HT Part No. B1A81UY--20C000313U1930			
Tentative Product	*****	*****		
Specifications are subject to changes for improvement without advance notice. Proprietary data, drawings, company confidential all rights reserved.		07/13/2022	Version	Page 13/14

- Avoid rubbing or scraping the resin by any object.
- Electric-static may cause damage to the component. Please ensure that the equipment is properly grounded. Use of an ionizer fan is recommended.

Official Product	HT Part No. B1A81UY--20C000313U1930			
Tentative Product	*****	*****		
Specifications are subject to changes for improvement without advance notice. Proprietary data, drawings, company confidential all rights reserved.		07/13/2022	Version	Page 14/14

Revise History

Rev.	Descriptions	Date	Page
2.0	(1) IF max :30mA(2) IFP:60mA	07/13/2022	-

Official Product	HT Part No. B1A81UY--20C000313U1930			
Tentative Product	*****	*****		
Specifications are subject to changes for improvement without advance notice. Proprietary data, drawings, company confidential all rights reserved.		07/13/2022	Version	Page 15/14