

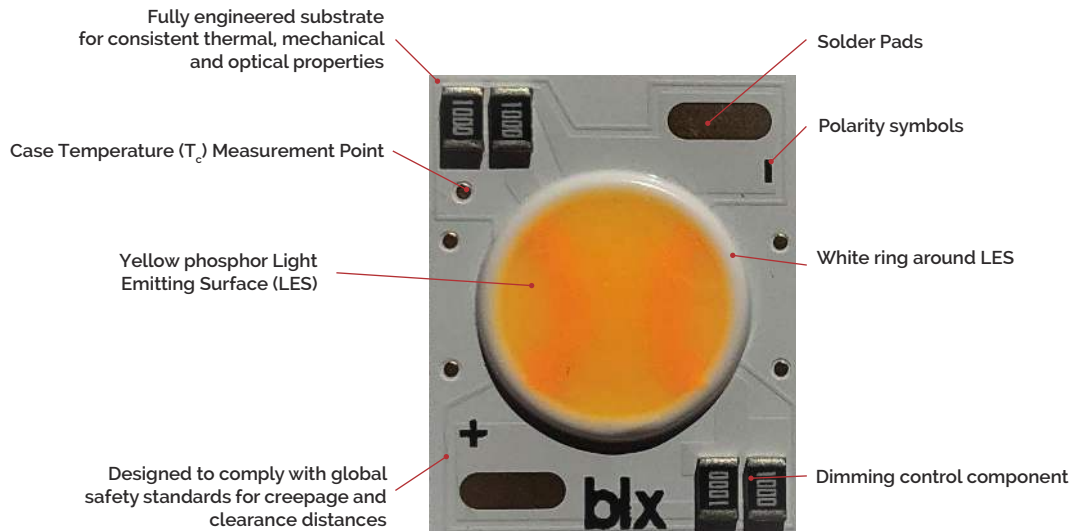
# Bridgelux® Vesta® Series Dim-To-Warm Gen 2 6mm Array

Product Data Sheet DS190



# Product Feature Map

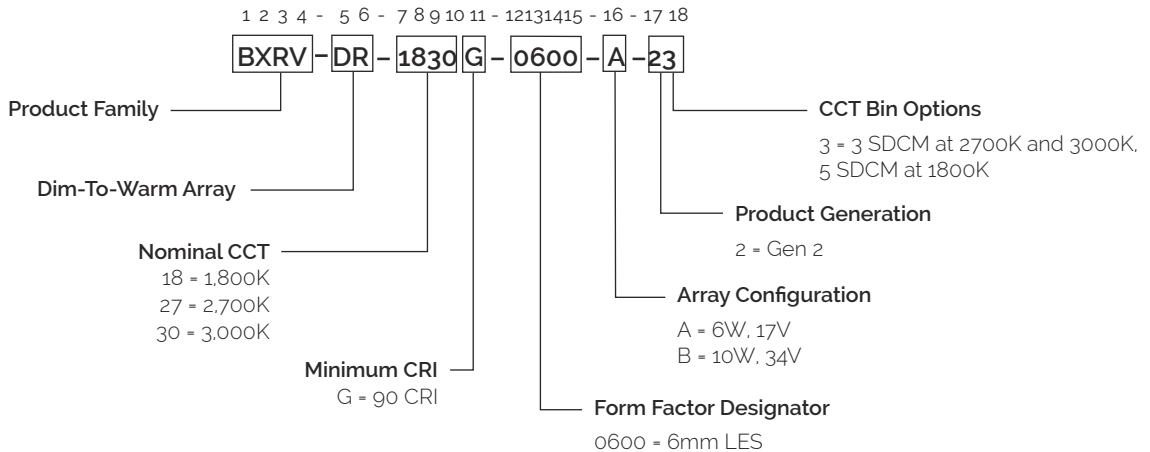
Bridgelux arrays are fully engineered devices that provide consistent thermal and optical performance on an engineered mechanical platform. The arrays incorporate several features to simplify design integration and assembly. Please visit [www.bridgelux.com](http://www.bridgelux.com) for more information on the Vesta Series family of products.



Note: Part number and lot codes are scribed on back of array

## Product Nomenclature

The part number designation for Bridgelux Vesta Series arrays is explained as follows:



# Product Selection Guide

The following product configurations are available:

**Table 1:** Selection Guide, Measurement Data

Part Number	Nominal CCT <sup>1</sup> (K)	Minimum CRI <sup>2</sup>	Drive Current (mA)	Typical V <sub>f</sub> T <sub>c</sub> =25°C (V)	Typical Power T <sub>c</sub> =25°C (W)	Typical Pulsed Flux <sup>3,4,5</sup> T <sub>c</sub> =25°C (lm)	Typical Efficacy T <sub>c</sub> =25°C (lm/W)	Minimum Pulsed Flux <sup>6,7</sup> T <sub>c</sub> =25°C (lm)	Typical DC Flux <sup>7,8</sup> T <sub>c</sub> =85°C (lm)
BXRV-DR-1827G-0600-A-23	2700	90	350	17.0	6.0	627	105	564	564
	1800	90	14	11.2	0.2	14	89	13	13
BXRV-DR-1830G-0600-A-23	3000	90	350	17.0	6.0	660	111	594	594
	1800	90	14	11.2	0.2	16	102	14	14
BXRV-DR-1827G-0600-B-23	2700	90	280	34.6	9.7	1026	106	923	923
	1800	90	14	27.3	0.4	40	105	36	36
BXRV-DR-1827H-0600-B-23	2700	95	280	34.6	9.7	840	87	756	756
	1800	93	14	27.3	0.4	30	78	27	27
BXRV-DR-1830G-0600-B-23	3000	90	280	34.6	9.7	1080	111	972	972
	1800	90	14	27.3	0.4	40	105	36	36
BXRV-DR-1830H-0600-B-23	3000	95	280	34.6	9.7	880	91	792	792
	1800	93	14	27.3	0.4	30	78	27	27

**Notes for Table 1:**

1. Nominal CCT as defined by ANSI C78.377-2017.
2. Minimum Rg value for 90/90 CRI products is 50. Bridgelux maintains a ±3 tolerance on all CRI and Rg values.
3. Products tested under pulsed condition (10ms pulse width) at nominal test current where T<sub>j</sub> (junction temperature) = T<sub>c</sub> (case temperature) = 25°C.
4. Typical performance values are provided as a reference only and are not a guarantee of performance.
5. Bridgelux maintains a ±7% tolerance on flux measurements.
6. Minimum flux values at the nominal test current are guaranteed by 100% test.
7. Typical stabilized DC performance values are provided as reference only and are not a guarantee of performance.
8. Typical performance is estimated based on operation under DC (direct current) with LED array mounted onto a heat sink with thermal interface material and the case temperature maintained at 85°C. Based on Bridgelux test setup, values may vary depending on the thermal design of the luminaire and/or the exposed environment to which the product is subjected.


# European Product Registry for Energy Labeling

The European Product Registry for Energy Labeling (EPREL) is defined in the EU Regulation 2017/1369 to provide information about a product's energy efficiency to consumers. Together with Energy Labeling Regulation ELR (EU) 2019/2015, which was amended by regulation (EU) 2021/340 for energy labelling of light sources, manufacturers are required to declare an energy class based on key technical specifications from each of their product and register it in an open data base managed by EPREL. It is now a legal requirement for a vendor of light sources to upload information about their products into the EPREL database before placing these products on the market in the EU.

Table 2 provides a list of part numbers that are in compliance with EPREL regulations and are currently listed in the EPREL database.

At Bridgelux, we are fully committed to supplying products that are compliant with pertinent laws, rules, and obligation imposed by relevant government bodies including the ELR regulation. Customers can use these products with full confidence for any projects that fall under the EPREL requirement.

**Table 2:** Table of products registered in the European Product Registry for Energy Labeling (EPREL)

Part Number	CCT (K)	CRI	Current <sup>3</sup> (mA)	Voltage <sup>3</sup> (V)	Useful Flux <sup>2</sup> $\Phi_{\text{useful}}$ Tc=85C (lm)	Power (W)	Efficacy (lm/W)	Energy Efficiency Class <sup>4</sup>	Registration No	URL <sup>1</sup>
BXRV-DR-1827G-0600-A-23	2700	90	400	16.8	645	6.7	96	F 	876240	<a href="https://eprelec.europa.eu/qr/876240">https://eprelec.europa.eu/qr/876240</a>
BXRV-DR-1830G-0600-A-23	3000	90	420	16.9	713	7.1	100	F	876248	<a href="https://eprelec.europa.eu/qr/876248">https://eprelec.europa.eu/qr/876248</a>
BXRV-DR-1827G-0600-B-23	2700	90	190	31.5	565	6.0	94	F	879003	<a href="https://eprelec.europa.eu/qr/879003">https://eprelec.europa.eu/qr/879003</a>
BXRV-DR-1830G-0600-B-23	3000	90	230	32.1	734	7.4	99	F	879017	<a href="https://eprelec.europa.eu/qr/879017">https://eprelec.europa.eu/qr/879017</a>

Notes for Table 2:

1. The performance data in this table is a subset of the data that was submitted to EPREL for obtaining the energy class listed here. For accessing a complete set of technical documentation of Bridgelux registered products in the EPREL database, please visit one of the hyperlinks listed above.
2. For a definition of useful luminous flux ( $\Phi_{\text{useful}}$ ), please see the ELR regulations at <https://tinyurl.com/4b6zvt4m>.
3. For information on performance values at alternative drive conditions, please refer to the Product Selection Guide, Absolute Maximum Rating Table and Performance Curves in this data sheet.
4. EPREL requires a symbol for displaying the energy classification of a product in marketing literature. This symbol consists of a letter stating a product's energy efficiency class inside a specific arrow logo as defined by EPREL.
5. All products listed here must be disposed as e-waste according to the guidelines in the country in which the product is used.

# Electrical Characteristics

**Table 3:** Electrical Characteristics

Part Number	Drive Current (mA)	Forward Voltage Pulsed, $T_c = 25^\circ\text{C}$ (V) <sup>1,2,3,7</sup>			Typical Coefficient of Forward Voltage <sup>4</sup> $\Delta V_f / \Delta T_c$ (mV/ $^\circ\text{C}$ )	Typical Thermal Resistance Junction to Case <sup>5</sup> $R_{j-c}$ ( $^\circ\text{C}/\text{W}$ )	Driver Selection Voltages <sup>6</sup> (V)	
		Minimum	Typical	Maximum			$V_f$ Min. Hot $T_c = 105^\circ\text{C}$ (V)	$V_f$ Max. Cold $T_c = -40^\circ\text{C}$ (V)
BXRV-DR-18xxX-0600-A-23	350	15.5	17.0	18.5	-6.1	0.89	15.0	18.9
	420	15.8	17.3	18.8	-6.1	0.92	15.3	19.2
BXRV-DR-18xxX-0600-B-23	280	31.6	34.6	37.6	-12.4	0.89	30.6	38.4
	350	32.4	35.5	38.6	-12.4	0.92	31.4	39.4

Notes for Table 3:

- Parts are tested in pulsed conditions.  $T_c = 25^\circ\text{C}$ . Pulse width is 10ms.
- Voltage minimum and maximum are provided for reference only and are not a guarantee of performance.
- Bridgelux maintains a tester tolerance of  $\pm 0.10\text{V}$  on forward voltage measurements.
- Typical coefficient of forward voltage tolerance is  $\pm 0.1\text{mV}$  for nominal current.
- Thermal resistance value was calculated using total electrical input power; optical power was not subtracted from input power. The thermal interface material used during testing is not included in the thermal resistance value.
- $V_f$  min hot and max cold values are provided as reference only and are not guaranteed by test. These values are provided to aid in driver design and selection over the operating range of the product.
- This product has been designed and manufactured per IEC 62031:2018. This product has passed dielectric withstand voltage testing at 500 V. The working voltage designated for the insulation is 45V d.c. The maximum allowable voltage across the array must be determined in the end product application.

# Absolute Maximum Ratings

**Table 4:** Maximum Ratings

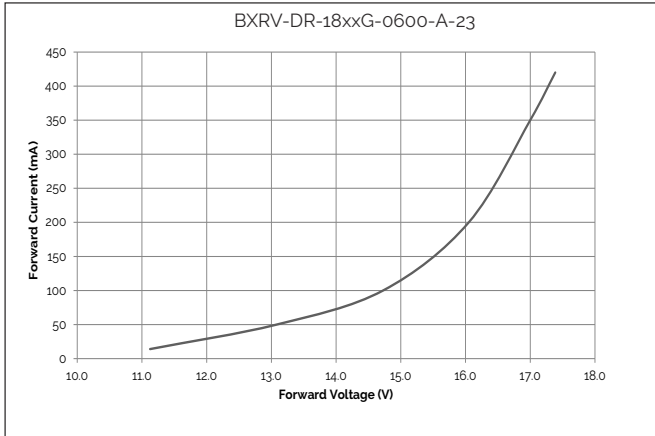
Parameter	Maximum Rating	
LED Junction Temperature ( $T_j$ )	125°C	
Storage Temperature	-40°C to +105°C	
Operating Case Temperature <sup>1</sup> ( $T_c$ )	105°C	
Soldering Temperature <sup>2</sup>	350°C or lower for a maximum of 10 seconds	
	BXRV-DR-18xxX-0600-A-23	BXRV-DR-18xxX-0600-B-23
Maximum Drive Current <sup>3</sup>	420mA	350mA
Maximum Peak Pulsed Drive Current <sup>4</sup>	600mA	500mA
Maximum Reverse Voltage <sup>5</sup>	-30V	-50V

Notes for Table 4:

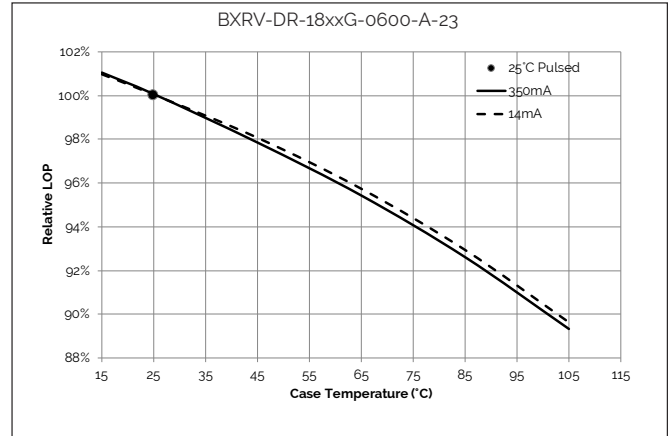
1. For IEC 62717 requirement, please contact Bridgelux Sales Support.
2. See Bridgelux Application Note AN101 "Handling and Assembly of LED Arrays" for more information.
3. Please refer to Figure 11 & 12 for a drive current derating curve.
4. Bridgelux recommends a maximum duty cycle of 10% and pulse width of 20ms when operating LED arrays at the maximum peak pulsed current specified. Maximum peak pulsed currents indicate values where the LED array can be driven without catastrophic failures.
5. Light emitting diodes are not designed to be driven in reverse voltage and will not produce light under this condition. Maximum rating provided for reference only.

# Performance Curves

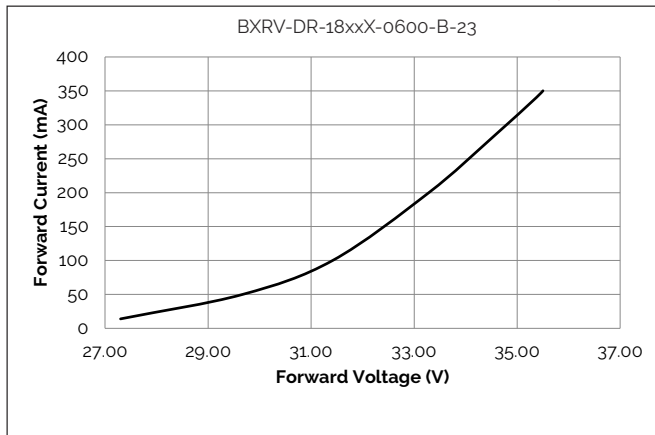
**Figure 1: Forward Voltage vs. Forward Current,  $T_c=25^\circ\text{C}$**



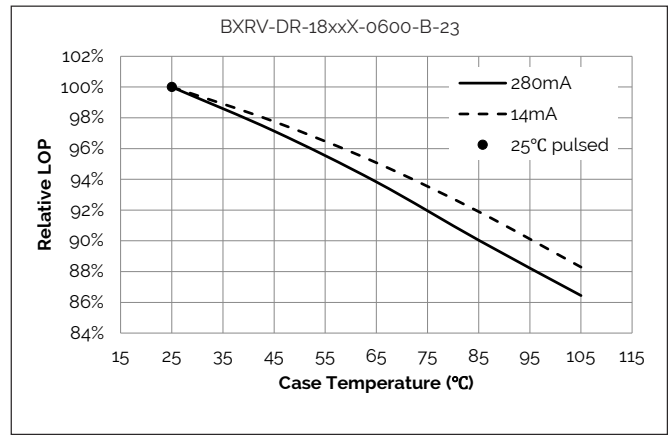
**Figure 2: Relative Flux vs. Case Temperature**



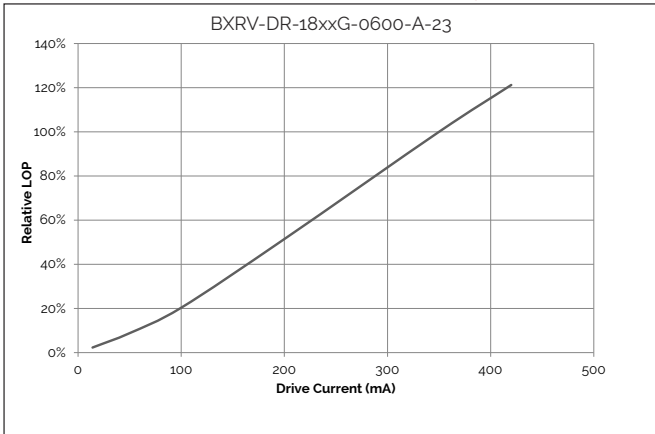
**Figure 3: Forward Voltage vs. Forward Current,  $T_c=25^\circ\text{C}$**



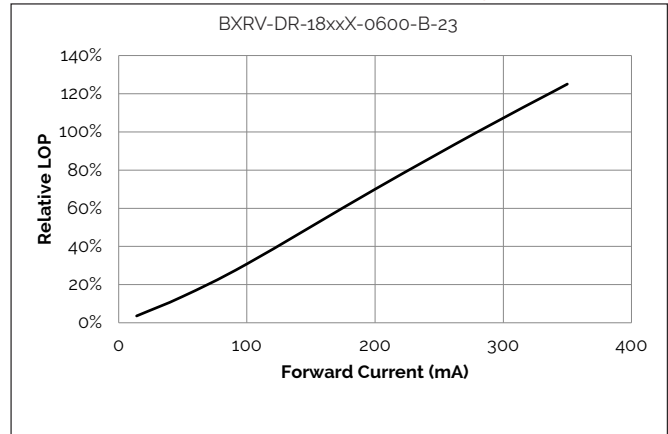
**Figure 4: Relative Flux vs. Case Temperature**



**Figure 5: Relative LOP vs. Drive Current,  $T_c=25^\circ\text{C}$**

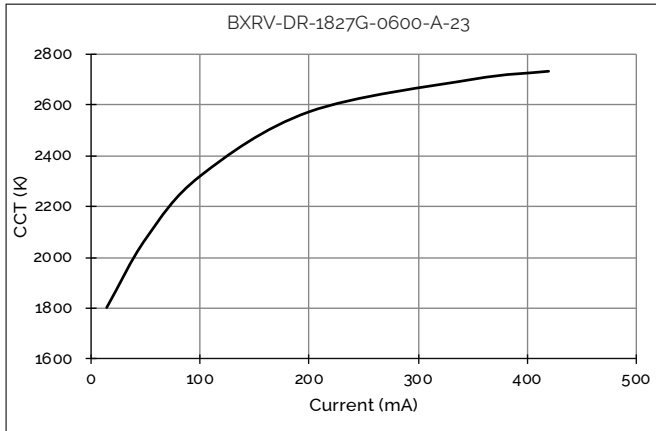


**Figure 6: Relative LOP vs. Drive Current,  $T_c=25^\circ\text{C}$**

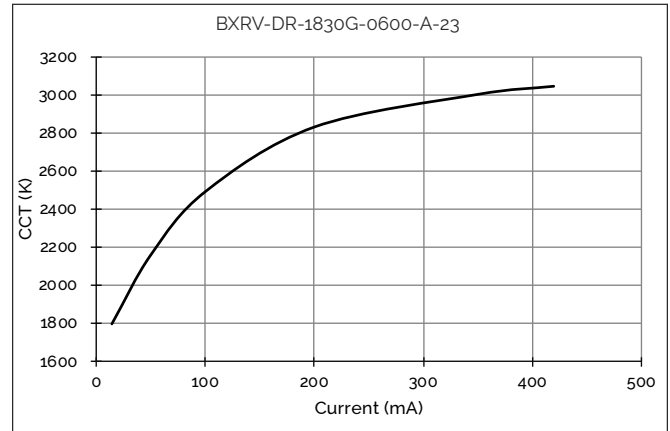


# Performance Curves

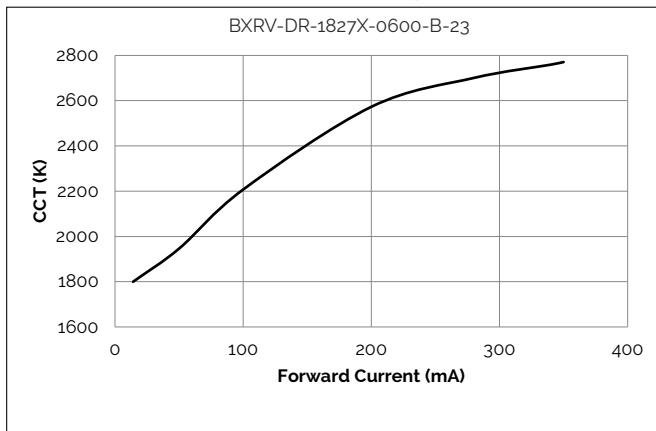
**Figure 7: CCT vs. Forward Current,  $T_c=25^\circ\text{C}$**



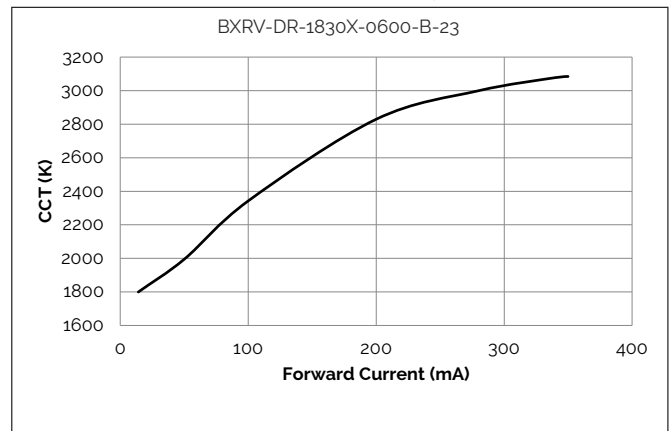
**Figure 8: CCT vs. Forward Current,  $T_c=25^\circ\text{C}$**



**Figure 9: CCT vs. Forward Current,  $T_c=25^\circ\text{C}$**



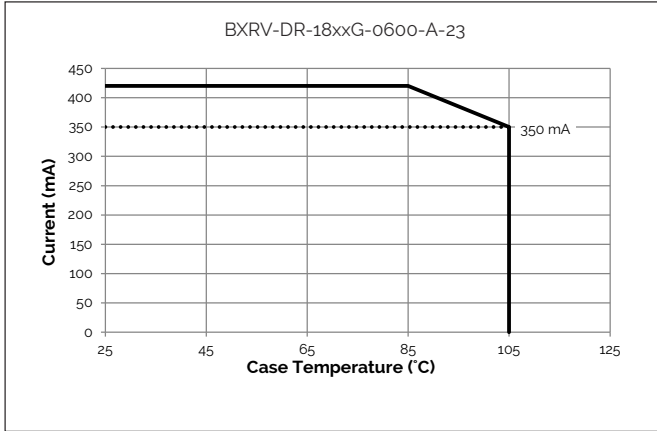
**Figure 10: CCT vs. Forward Current,  $T_c=25^\circ\text{C}$**



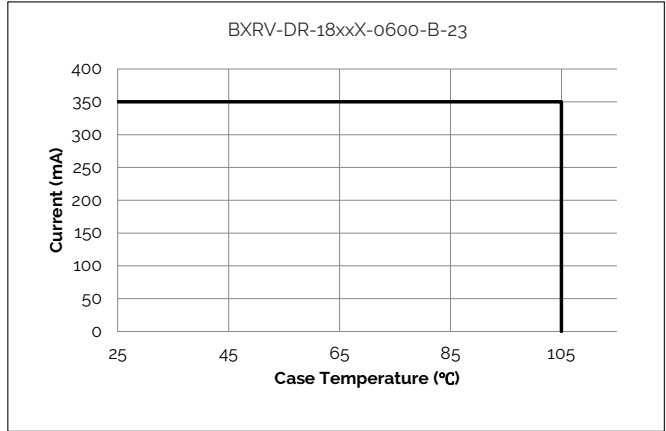


# Performance Curves

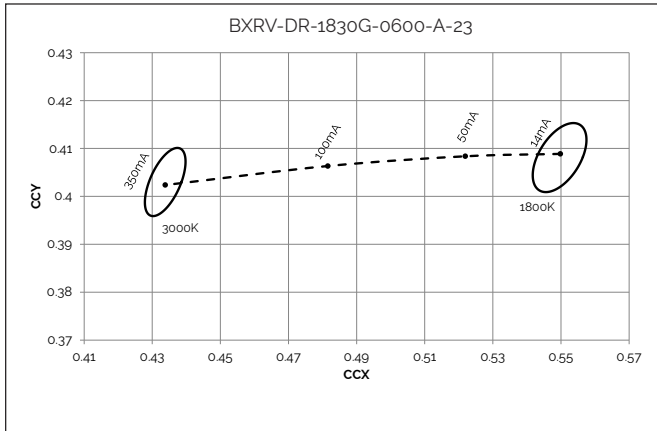
**Figure 11: Derating Curve**



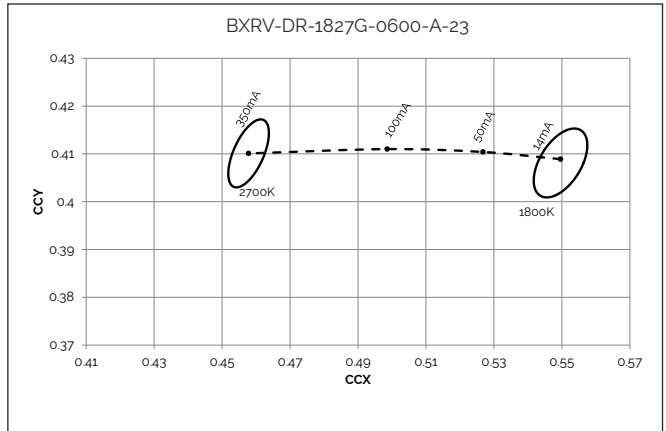
**Figure 12: Derating Curve**



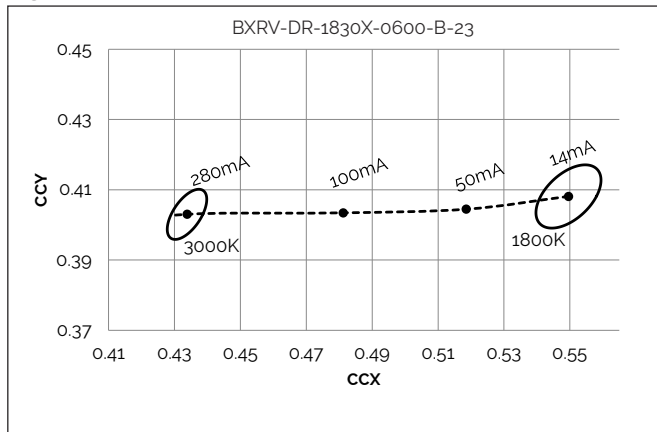
**Figure 13: Color shift vs. Forward Current 3000K - 1800K**



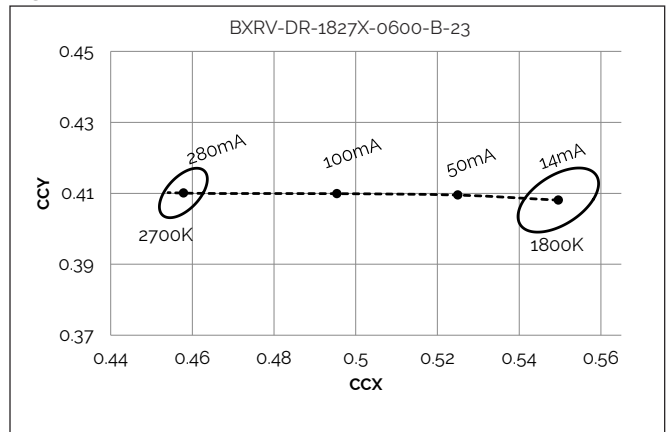
**Figure 14: Color shift vs. Forward Current 2700K - 1800K**



**Figure 15: Color shift vs. Forward Current 3000K - 1800K**



**Figure 16: Color shift vs. Forward Current 2700K - 1800K**



# Typical Radiation Pattern

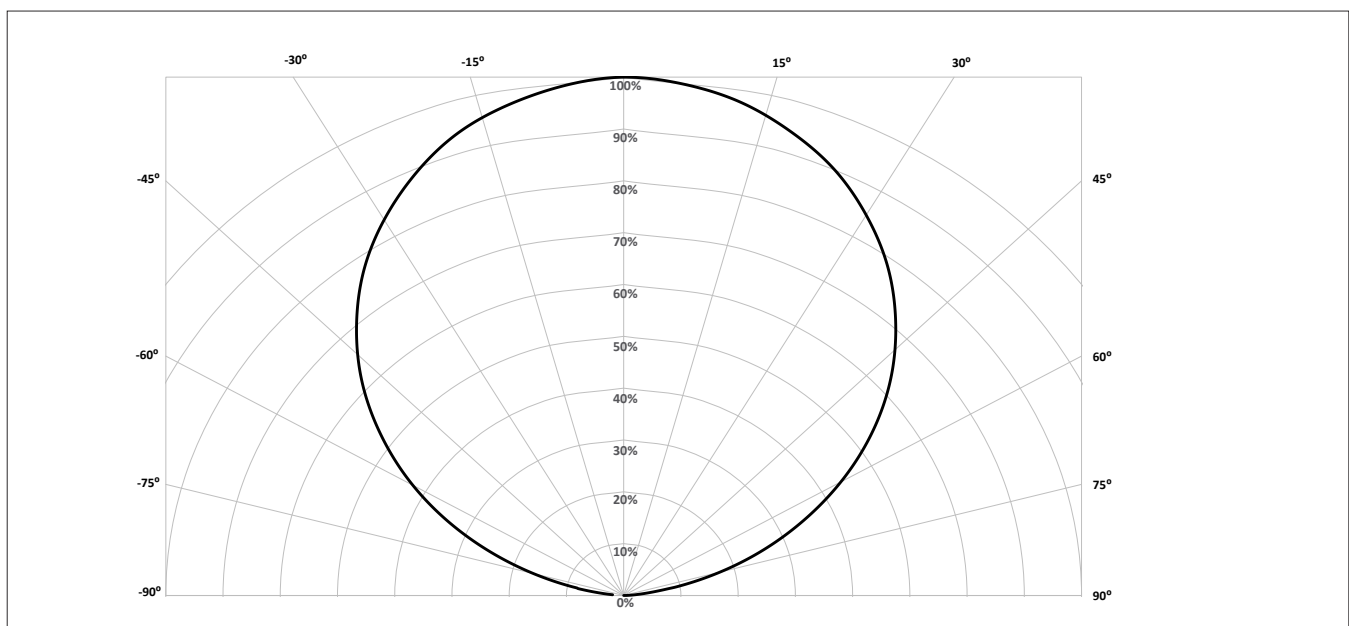
**Figure 17: Typical Spatial Radiation Pattern**



Notes for Figure 17:

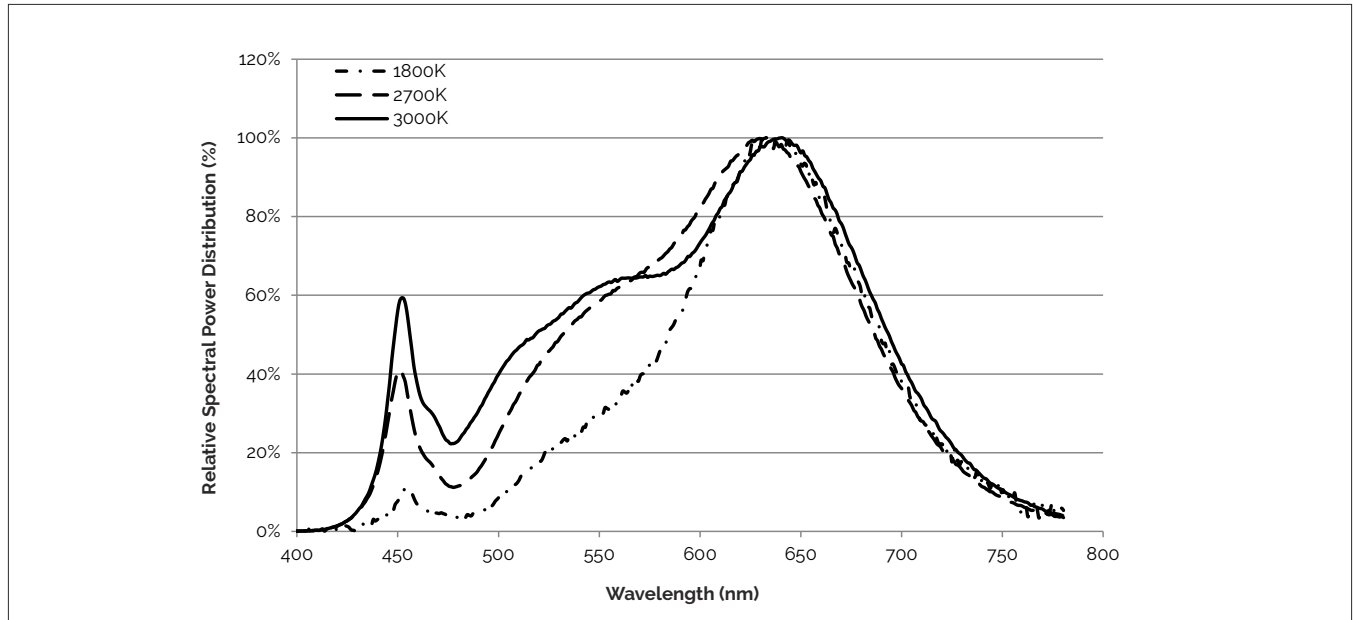
1. Typical viewing angle is 110°.
2. The viewing angle is defined as the off axis angle from the centerline where  $I_v$  is  $\frac{1}{2}$  of the peak value.

**Figure 18: Typical Polar Radiation Pattern**



# Typical Color Spectrum

Figure 19: Typical Color Spectrum

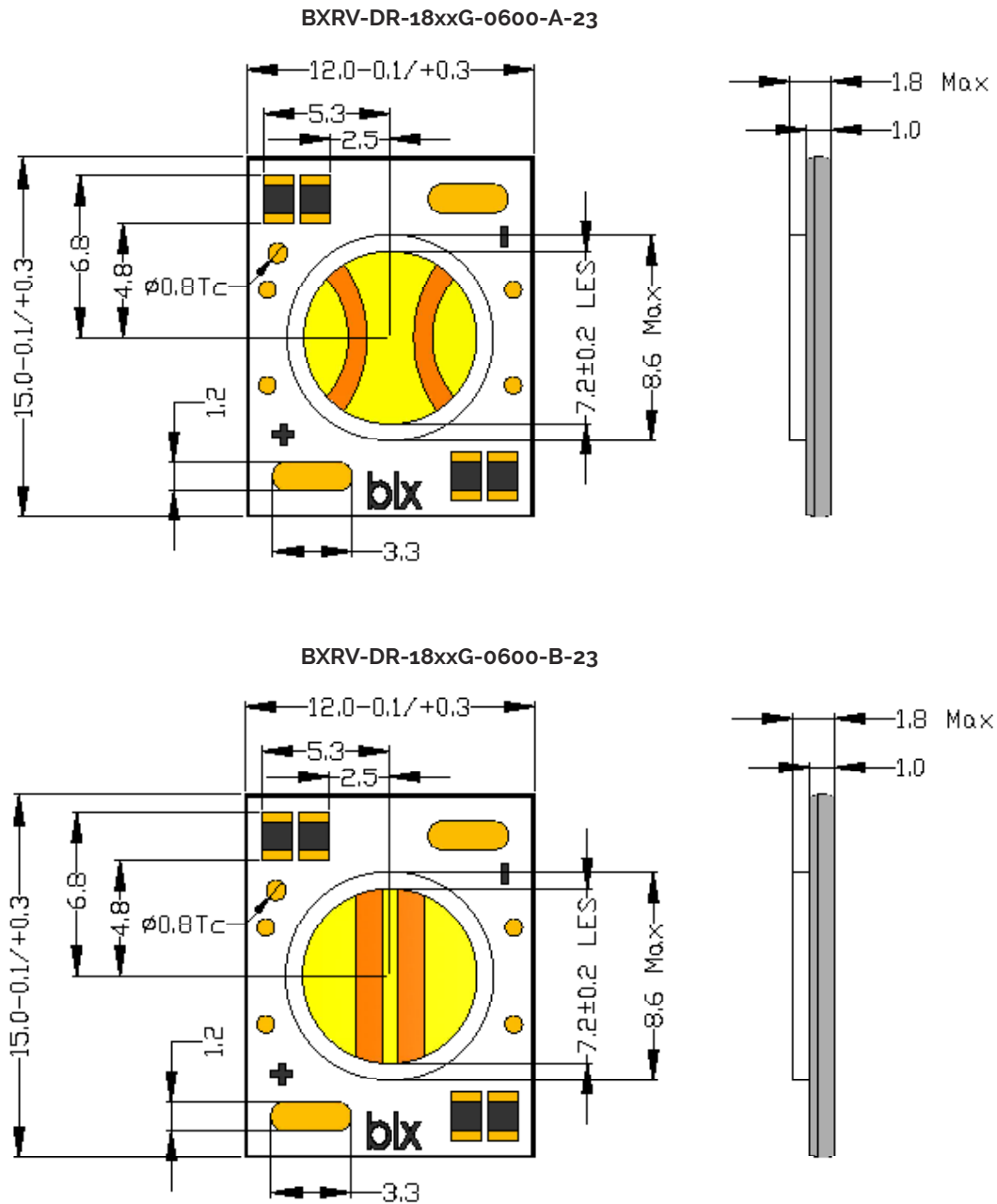


Note for Figure 19:

1. Color spectra measured at nominal current for  $T_j = T_c = 25^\circ\text{C}$ .

# Mechanical Dimensions

Figure 20: Mechanical Drawing Specifications



Notes for Figure 20:

1. Drawings are not to scale.
2. Drawing dimensions are in millimeters.
3. Unless otherwise specified, tolerances are  $\pm 0.10\text{mm}$ .
4. Bridgelux maintains a flatness of 0.1 mm across the mounting surface of the array. Refer to Application Notes for product handling, mounting and heat sink recommendations.
5. The optical center of the LED array is nominally defined by the mechanical center of the array. The light emitting surface (LES) is centered on the mechanical center of the array to a tolerance of  $\pm 0.2\text{ mm}$ .
6. Solder pads are labeled "+" to denote positive polarity, and "-" to denote negative polarity.

# Color Binning Information

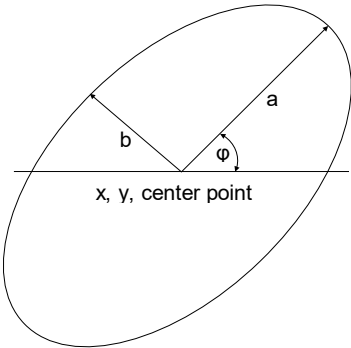
**Table 5:** McAdam ellipse CCT color bin definitions for product operating at  $T_c = 25^\circ\text{C}$

CCT	Center Point	Bin Size	Axis a	Axis b	Rotation Angle
1800K	x=0.5496 y=0.4081	5 SDCM	0.01164	0.00655	40.00°
2700K	x=0.4578 y= 0.4101	3 SDCM	0.00810	0.00420	53.70°
3000K	x=0.4338 y=0.4030	3 SDCM	0.00834	0.00408	53.22°

Notes for Table 5:

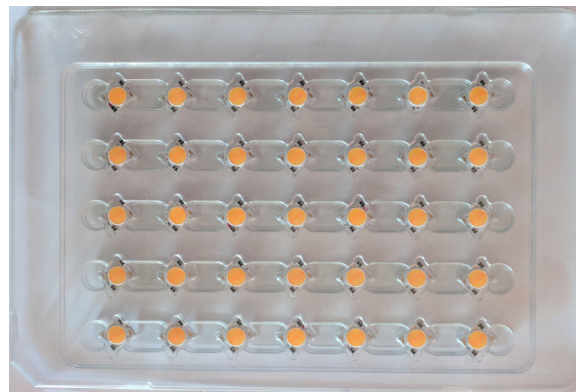
1. The x,y center points are the center points of the respective ANSI bins in the CIE 1931 xy Color Space
2. Products are binned at  $T_c=25^\circ\text{C}$
3. Bridgelux maintains a tolerance of +/-0.007 on x and y color coordinates in the CIE 1931 Color Space

**Figure 21: Definition of the McAdam ellipse**



# Packaging and Labeling

**Figure 22: Packaging Specifications**



Notes for Figure 22:

1. Each tray holds 35 Vesta Series Dim-To-Warm 6mm arrays.
2. Eight trays are sealed in an anti-static bag. One such bag is placed in a box and shipped. Depending on quantities ordered, a bigger shipping box, containing more boxes will be used to ship products.
3. Each bag and box is to be labeled as shown above.
4. Dimensions for each tray are 200 (W) x 12(H) x 300 (L) mm. Dimensions for the anti-static bag are 440 (W) x 350mm (L) x 0.1 mm (T) and that of a shipping box are 350 x 245 x 67 mm.

**Figure 23: Product Labeling**

Bridgelux arrays have laser markings on the back side of the substrate to help with product identification. In addition to the product identification markings, Bridgelux arrays also contain markings for internal Bridgelux manufacturing use only. The image below shows which markings are for customer use and which ones are for Bridgelux internal use only. The Bridgelux internal manufacturing markings are subject to change without notice, however these will not impact the form, function or performance of the array.



Customer Use- 2D Barcode  
Scannable barcode provides product part number and other Bridgelux internal production information.

Customer Use- Product part number ———— • **1830G06A 13** ———— Internal Bridgelux use only.

# Design Resources

## Application Notes

Bridgelux has developed a comprehensive set of application notes and design resources to assist customers in successfully designing with the Vesta Series product family of LED array products. Please see Bridgelux Application Note, AN101 for more information. For a list of resources under development visit [www.bridgelux.com](http://www.bridgelux.com).

## Optical Source Models

Optical source models and ray set files are available for all Bridgelux products. For a list of available formats, visit [www.bridgelux.com](http://www.bridgelux.com).

## 3D CAD Models

Three dimensional CAD models depicting the product outline of all Bridgelux Vesta Series LED arrays are available in both IGES and STEP formats. Please contact your Bridgelux sales representative for assistance.

## LM80

LM80 testing has been completed and the LM80 report is now available. Please contact your Bridgelux sales representative for LM-80 report.

# Precautions

## CAUTION: CHEMICAL EXPOSURE HAZARD

Exposure to some chemicals commonly used in luminaire manufacturing and assembly can cause damage to the LED array. Please consult Bridgelux Application Note for additional information.

## CAUTION: EYE SAFETY

Eye safety classification for the use of Bridgelux Vesta Series is in accordance with IEC/TR62778: Application of IEC 62471 for the assessment of blue light hazard to light sources and luminaires. Vesta Series Dim-To-Warm arrays are classified as Risk Group 1 when operated at or below the maximum drive current. Please use appropriate precautions. It is important that employees working with LEDs are trained to use them safely.

## CAUTION: RISK OF BURN

Do not touch the Vesta Series LED array during operation. Allow the array to cool for a sufficient period of time before handling. The Vesta Series LED array may reach elevated temperatures such that could burn skin when touched.

## CAUTION

### CONTACT WITH LIGHT EMITTING SURFACE (LES)

Do not touch the LES (Light Emitting Surface, defined by the yellow phosphor resin area). Do not apply any stress to the LES or resistors to avoid damage to the LED array.

Holder and secondary optics may be mounted on the top surface of the Vesta Series array as long as they do not make contact with the LES and resistors. Use the edges of the Vesta Series array to align and mount holder and secondary optics devices.

# Disclaimers

## STANDARD TEST CONDITIONS

Unless otherwise stated, array testing is performed at the nominal drive current.

## MINOR PRODUCT CHANGE POLICY

The rigorous qualification testing on products offered by Bridgelux provides performance assurance. Slight cosmetic changes that do not affect form, fit, or function may occur as Bridgelux continues product optimization.

# About Bridgelux: Bridging Light and Life™

At Bridgelux, we help companies, industries and people experience the power and possibility of light. Since 2002, we've designed LED solutions that are high performing, energy efficient, cost effective and easy to integrate. Our focus is on light's impact on human behavior, delivering products that create better environments, experiences and returns—both experiential and financial. And our patented technology drives new platforms for commercial and industrial luminaires.

**For more information about the company, please visit**

**[bridgelux.com](http://bridgelux.com)**

**[twitter.com/Bridgelux](https://twitter.com/Bridgelux)**

**[facebook.com/Bridgelux](https://facebook.com/Bridgelux)**

**[youtube.com/user/Bridgelux](https://youtube.com/user/Bridgelux)**

**[linkedin.com/company/bridgelux](https://linkedin.com/company/bridgelux)**

**WeChat ID: BridgeluxInChina**



46410 Fremont Blvd  
Fremont, CA 94538 USA  
Tel (925) 583-8400  
**[www.bridgelux.com](http://www.bridgelux.com)**

© 2021 Bridgelux, Inc. All rights reserved 2021. Product specifications are subject to change without notice. Bridgelux and the Bridgelux stylized logo design are registered trademarks of Bridgelux, Inc. and Vesta Series is a registered trademark of Bridgelux, Inc. All other trademarks are the property of their respective owners.

**Bridgelux Vesta Series Dim-To-Warm Gen 2 6mm Array Product Data Sheet DS190 Rev. C (08/2022)**