

UNIT:mm

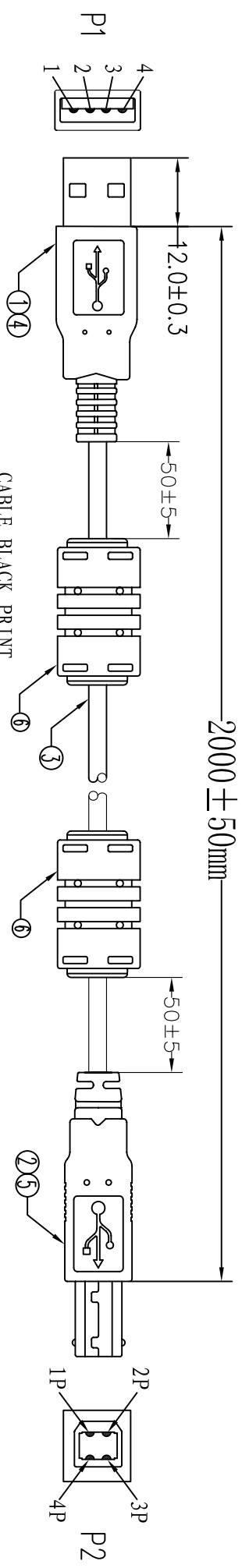

CABLE BLACK PRINT
 HI-SPEED USB Revision 2.0 SHIELDED 28AWG/1P+24AWG/2C
 E189529 AWM STYLE 2725 80° C 30V VW-1 VEGA TECH

PIN ASSIGNMENT :

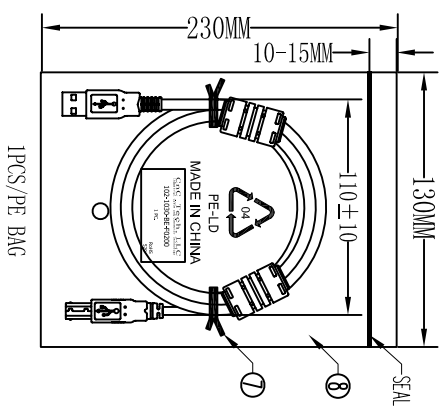
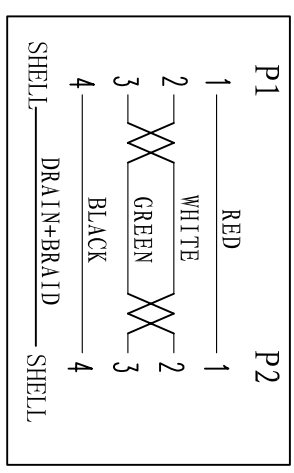

Electrical test:
 1. 100% short, open, miswire test
 2. Conduct resistance: 2 Ohm(max)
 3. Insulation resistance: 10Mohm(min)
 4. dielectric test: DC 300V

⑨	PE BAG	1/10	CLEAR SIZE:280*330*0.05mm PRINT BLACK"MADE IN CHINA"+*10PCS".
⑩	PE BAG	1	CLEAR SIZE:130*230*0.05mm PRINT BLACK"MADE IN CHINA"+*1PC".
⑦	TIE	2	WHITE L=100mm
⑥	OUT JACKET	18g	BEIGE 45P PVC (MOULD NO:CH003)
	FERRITE	2	CORE OD12*5.6*L20 BLACK
⑤	OUT JACKET	6g	BEIGE(V-29#) PVC-40P (MOULD NO:WM-65)
④	OUT JACKET	6g	BEIGE(V-29#) PVC-40P (MOULD NO:WM-40)
③	CABLE	1	BEIGE(V-29#) USB2.0 UL2725 28#/1P+24# /2C+AEB OD:4.7mm L=2000±15mm
②	CONN	1set	USB2.0 B MALE SHELL:NICKEL PIN G/F 3PCS TYPE INSULATOR COLOR:WHITE
①	CONN	1set	USB2.0 A MALE SHELL:NICKEL PIN G/F 3PCS TYPE INSULATOR COLOR:WHITE
NO.	NAME	QTY	SPECIFICATION

CNC Tech, LLC
 Industrial Cable and Connector Technology

DRAWN	ZHONGHS	DRAWING NO	
CHECKED		CUSTOMER	
APPROVAL		ITEM NO.	102-1030-BE-F0200
DECIDED		DATE	2012-02-14
VERSIONS/EDITION	A/0	PROJECTION	

A

B

C

D

4

3

2

1

A

B

C

D

4

3

2

1