

NP15P04SLG

-40V – -15A – P-channel Power MOS FET

R07DS1509EJ0100

Application : Automotive

Rev.1.00

May. 20, 2022

Description

This product is P-channel MOS Field Effect Transistor designed for high current switching applications.

Features

- Super low on-state resistance : $R_{DS(on)} = 40 \text{ m}\Omega \text{ Max. (} V_{GS} = -10 \text{ V, } I_D = -7.5 \text{ A)}$
 $R_{DS(on)} = 60 \text{ m}\Omega \text{ Max. (} V_{GS} = -4.5 \text{ V, } I_D = -7.5 \text{ A)}$
- Low input capacitance : $C_{iss} = 1100 \text{ pF Typ.}$
- Built-in gate protection diode
- Designed for automotive application and AEC-Q101 qualified.
- Pb-free (This product does not contain Pb in the external electrode)

Outline

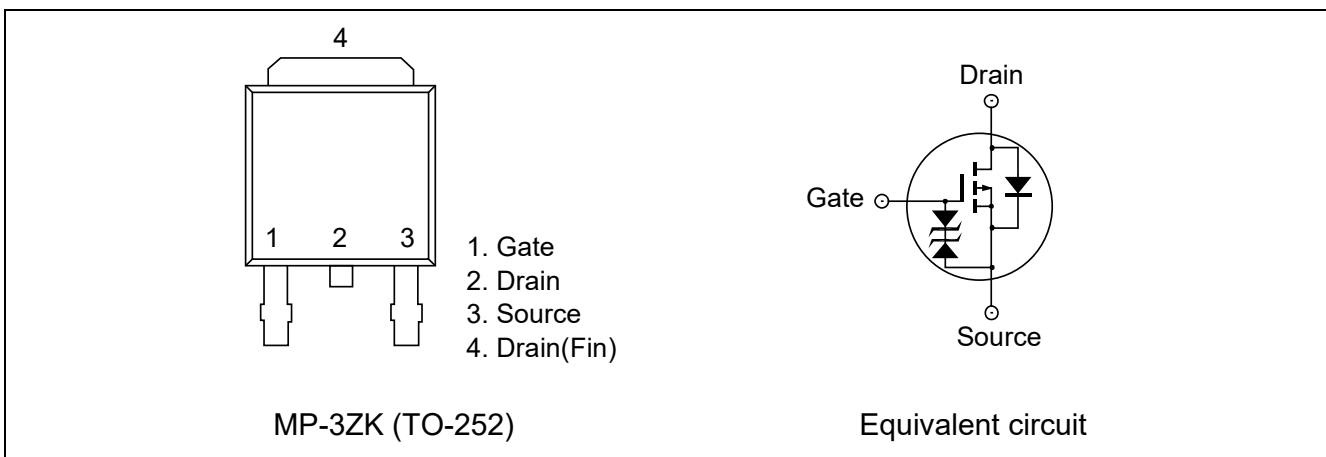

Absolute Maximum Ratings

($T_a=25^\circ\text{C}$)

Item	Symbol	Ratings	Unit
Drain to Source Voltage ($V_{GS} = 0 \text{ V}$)	V_{DSS}	-40	V
Gate to Source Voltage ($V_{DS} = 0 \text{ V}$)	V_{GSS}	∓ 20	V
Drain Current (DC) ($T_c = 25^\circ\text{C}$)	$I_{D(DC)}$	∓ 15	A
Drain Current (pulse)	$I_{D(pulse)}$ ^{Notes1}	∓ 45	A
Total Power Dissipation ($T_c = 25^\circ\text{C}$)	P_{T1}	30	W
Total Power Dissipation ($T_a = 25^\circ\text{C}$)	P_{T2}	1.2	W
Channel Temperature	T_{ch}	175	$^\circ\text{C}$
Storage Temperature	T_{stg}	-55 to 175	$^\circ\text{C}$
Single Avalanche Current	I_{AS} ^{Notes2}	16	A
Single Avalanche Energy	E_{AS} ^{Notes2}	25	mJ

Notes 1. $PW \leq 10 \mu\text{s}$, Duty Cycle $\leq 1\%$

2. Starting $T_{ch}=25^\circ\text{C}$, $V_{DD} = -20\text{V}$, $R_G = 25 \Omega$, $V_{GS} = -20 \rightarrow 0\text{V}$, $L = 100\mu\text{H}$

Thermal Resistance

Channel to Case Thermal Resistance	$R_{th(ch-c)}$ ^{Notes3}	5.0	°C/W
Channel to Ambient Thermal Resistance	$R_{th(ch-a)}$ ^{Notes3}	125	°C/W

Electrical Characteristics

(T_a=25°C)

Item	Symbol	Min	Typ	Max	Unit	Test Conditions
Zero Gate Voltage Drain Current	I_{DSS}	—	—	-10	μA	V _{DS} = -40 V, V _{GS} = 0 V
Gate Leakage Current	I_{GSS}	—	—	±10	μA	V _{GS} = ±20 V, V _{DS} = 0 V
Gate to Source Threshold Voltage	V _{GS(th)}	-1.0	-1.6	-2.5	V	V _{DS} = V _{GS} , I _D = -250 μA
Forward Transfer Admittance	y _{fs} ^{Notes4}	6	12	—	S	V _{DS} = -10 V, I _D = -7.5 A
Drain to Source On-state Resistance	$R_{DS(on)1}$ ^{Notes4}	—	31	40	mΩ	V _{GS} = -10 V, I _D = -7.5 A
	$R_{DS(on)2}$ ^{Notes4}	—	38	60	mΩ	V _{GS} = -4.5 V, I _D = -7.5 A
Input Capacitance	C _{iss}	—	1100	—	pF	V _{DS} = -10 V
Output Capacitance	C _{oss}	—	190	—	pF	V _{GS} = 0 V
Reverse Transfer Capacitance	C _{rss}	—	140	—	pF	f = 1 MHz
Turn-on Delay Time	t _{d(on)}	—	7	—	ns	V _{DD} = -20 V
Rise Time	t _r	—	5	—	ns	I _D = -7.5 A
Turn-off Delay Time	t _{d(off)}	—	100	—	ns	V _{GS} = -10 V
Fall Time	t _f	—	65	—	ns	R _G = 0 Ω
Total Gate Charge	Q _g	—	23	—	nC	V _{DD} = -32 V
Gate to Source Charge	Q _{gs}	—	3	—	nC	V _{GS} = -10 V
Gate to Drain Charge	Q _{gd}	—	7	—	nC	I _D = -15 A
Body Diode Forward Voltage	V _{F(S-D)} ^{Notes4}	—	0.94	1.5	V	I _F = -15 A, V _{GS} = 0 V
Reverse Recovery Time	t _{rr}	—	32	—	ns	I _F = -15 A, V _{GS} = 0 V
Reverse Recovery Charge	Q _{rr}	—	33	—	nC	di/dt = -100 A/μs

Note 3. Designed target value on Renesas measurement condition. Not subject to production test.

4. Pulse test.

Typical Characteristics

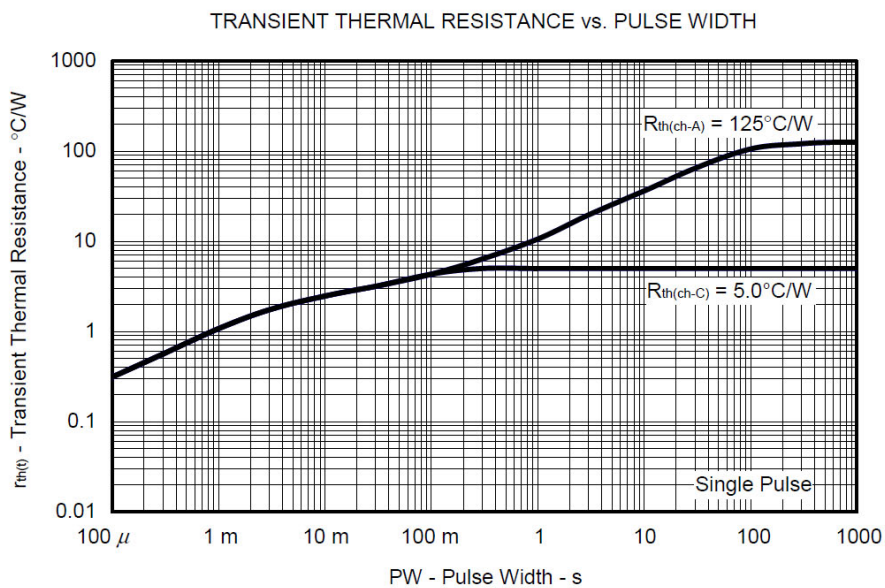
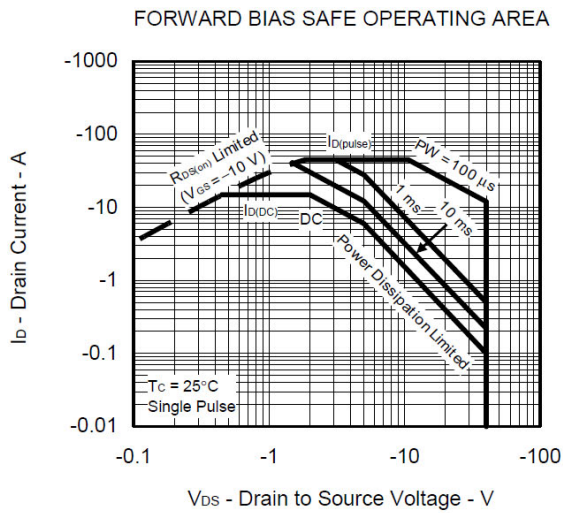
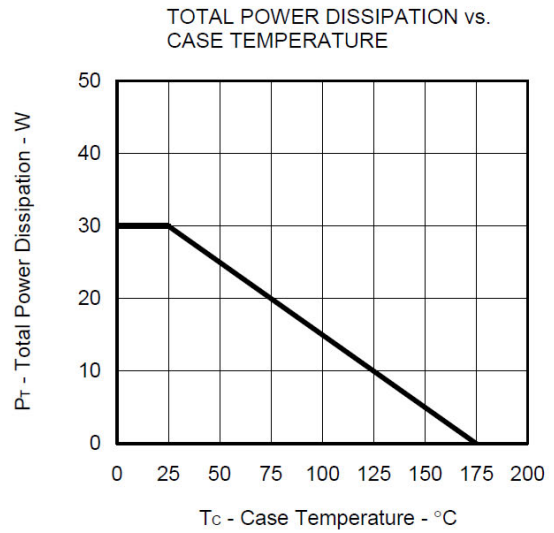
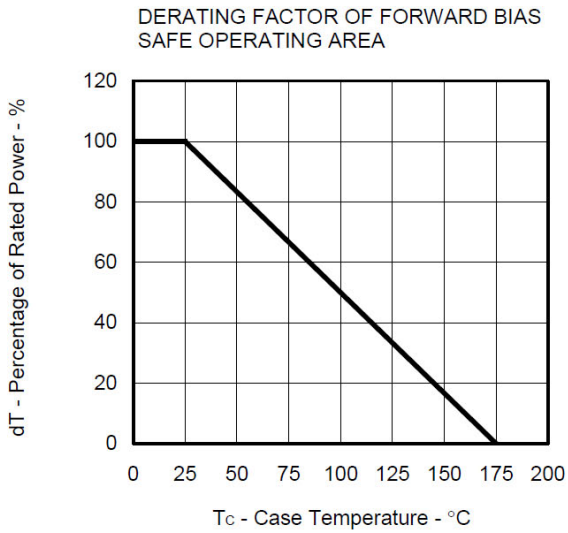

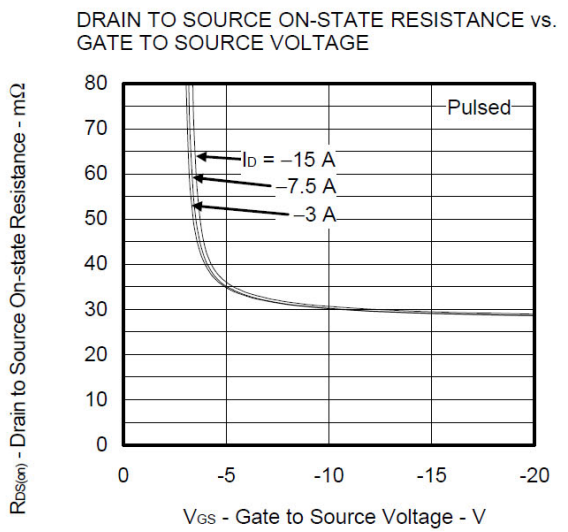
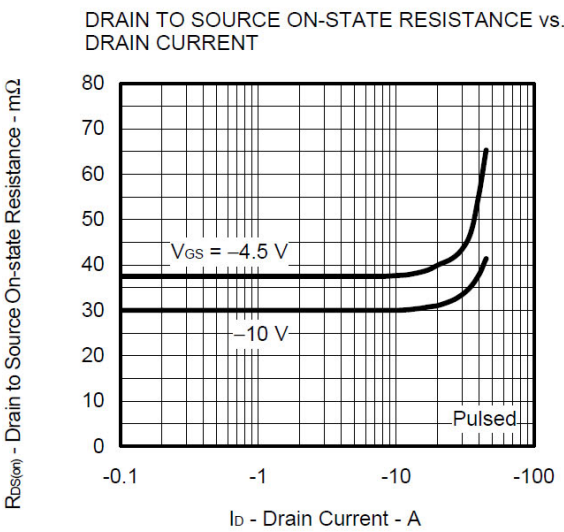
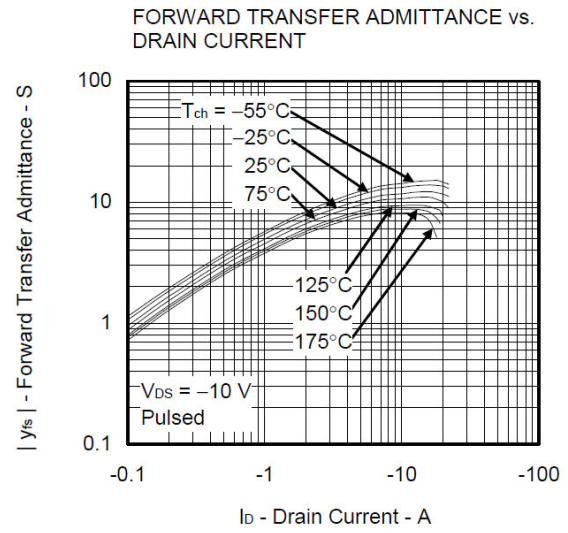
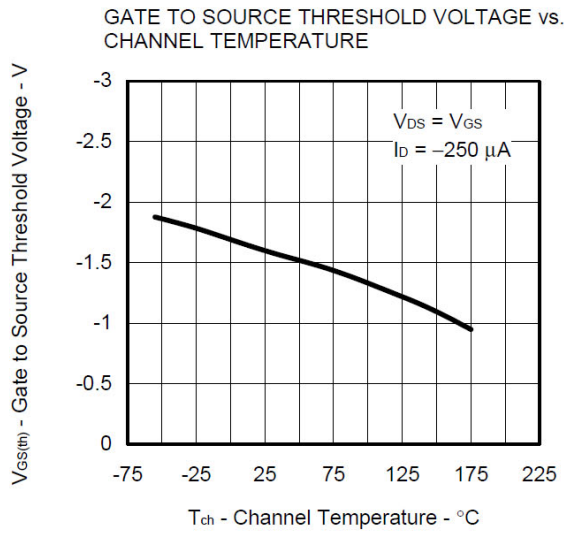
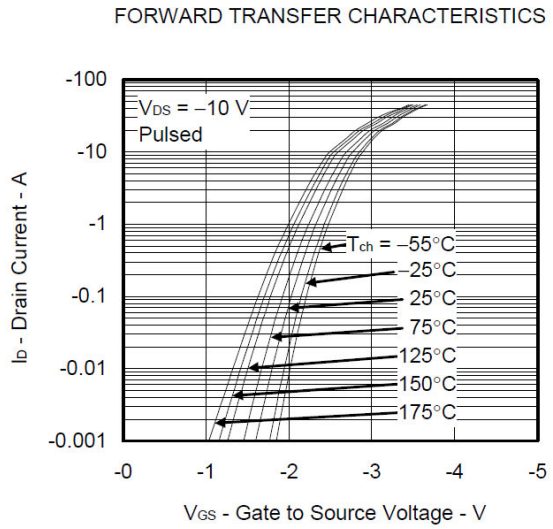
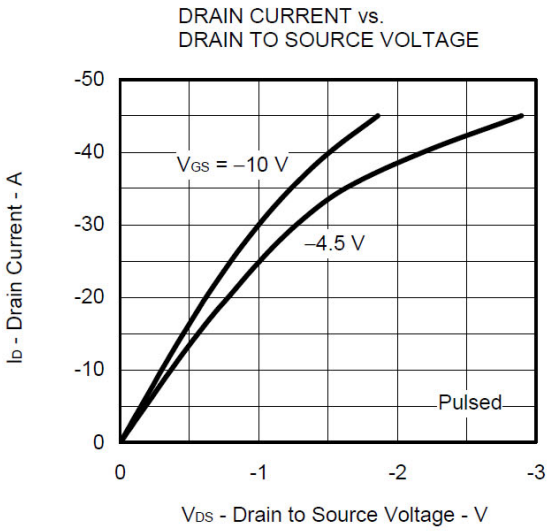

DRAIN TO SOURCE ON-STATE RESISTANCE vs. CHANNEL TEMPERATURE

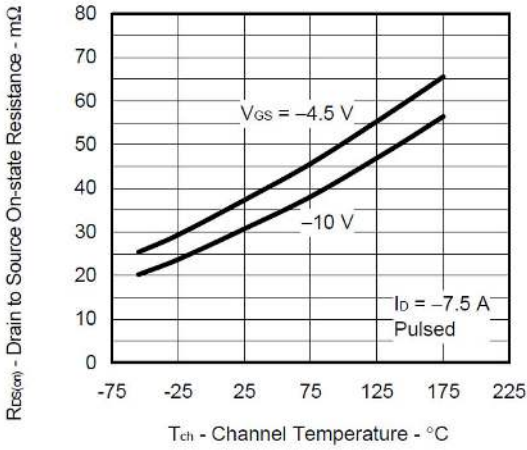

CAPACITANCE vs. DRAIN TO SOURCE VOLTAGE

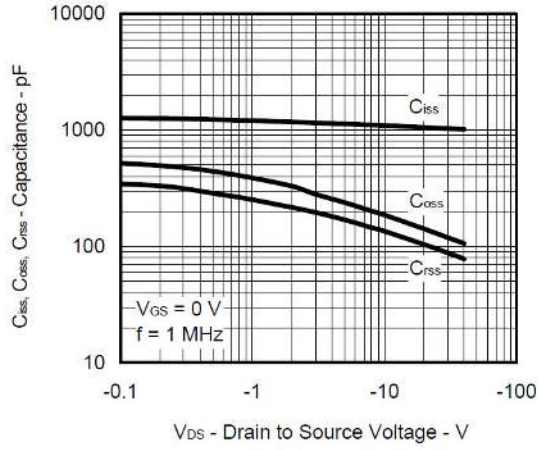

SWITCHING CHARACTERISTICS

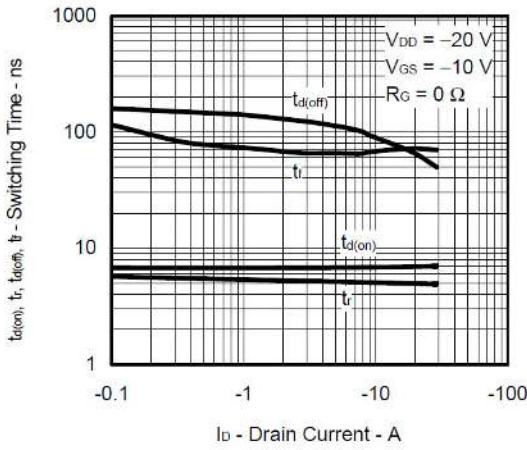

DYNAMIC INPUT/OUTPUT CHARACTERISTICS

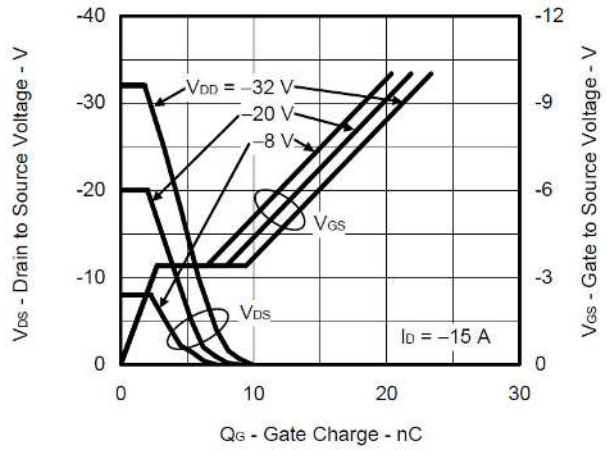

SOURCE TO DRAIN DIODE FORWARD VOLTAGE

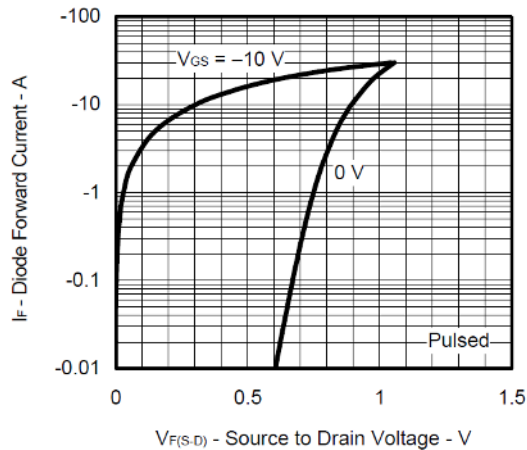

REVERSE RECOVERY TIME vs. DIODE FORWARD CURRENT

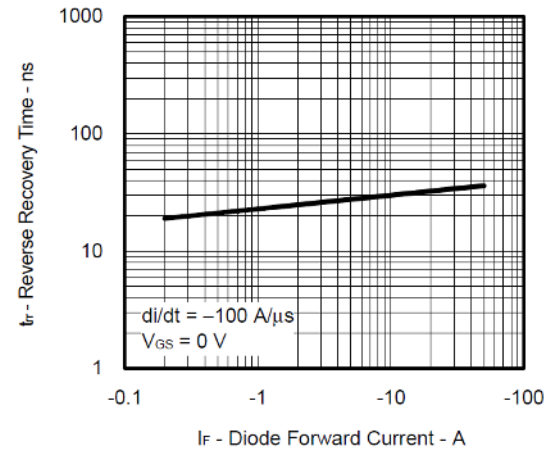

Test Circuit

Avalanche

Test Circuit

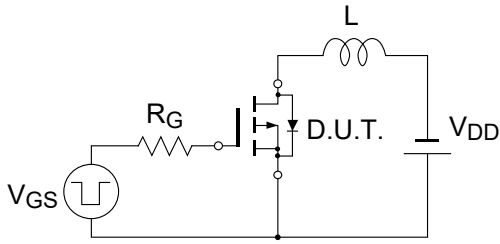

Waveform

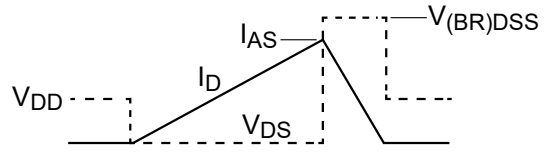

$$E_{AS} = \frac{1}{2} \cdot L \cdot I_{AS}^2 \cdot \frac{V_{(BR)DSS}}{V_{(BR)DSS} - V_{DD}}$$

Switching Time

Test Circuit

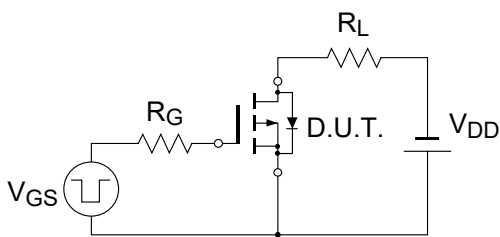

Waveform

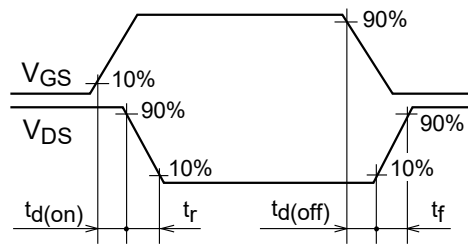

Gate Charge

Test Circuit

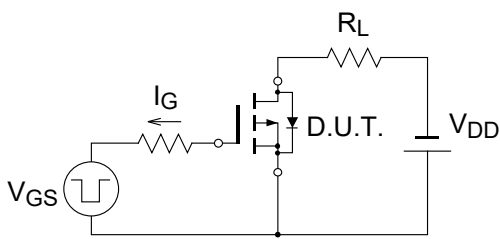

Waveform

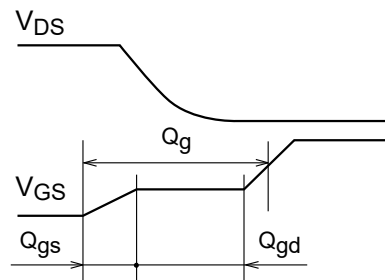

Reverse Recovery

Test Circuit

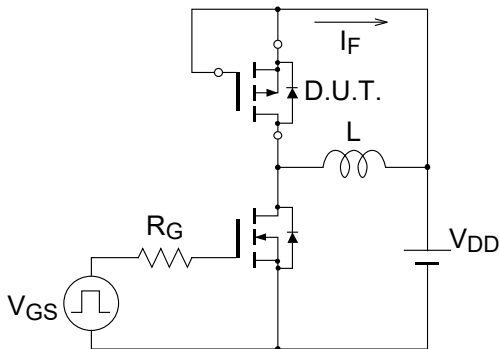

Waveform

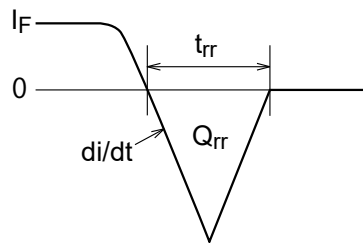

Notice

1. Descriptions of circuits, software and other related information in this document are provided only to illustrate the operation of semiconductor products and application examples. You are fully responsible for the incorporation or any other use of the circuits, software, and information in the design of your product or system. Renesas Electronics disclaims any and all liability for any losses and damages incurred by you or third parties arising from the use of these circuits, software, or information.
 2. Renesas Electronics hereby expressly disclaims any warranties against and liability for infringement or any other claims involving patents, copyrights, or other intellectual property rights of third parties, by or arising from the use of Renesas Electronics products or technical information described in this document, including but not limited to, the product data, drawings, charts, programs, algorithms, and application examples.
 3. No license, express, implied or otherwise, is granted hereby under any patents, copyrights or other intellectual property rights of Renesas Electronics or others.
 4. You shall be responsible for determining what licenses are required from any third parties, and obtaining such licenses for the lawful import, export, manufacture, sales, utilization, distribution or other disposal of any products incorporating Renesas Electronics products, if required.
 5. You shall not alter, modify, copy, or reverse engineer any Renesas Electronics product, whether in whole or in part. Renesas Electronics disclaims any and all liability for any losses or damages incurred by you or third parties arising from such alteration, modification, copying or reverse engineering.
 6. Renesas Electronics products are classified according to the following two quality grades: "Standard" and "High Quality". The intended applications for each Renesas Electronics product depends on the product's quality grade, as indicated below.
 - "Standard": Computers; office equipment; communications equipment; test and measurement equipment; audio and visual equipment; home electronic appliances; machine tools; personal electronic equipment; industrial robots; etc.
 - "High Quality": Transportation equipment (automobiles, trains, ships, etc.); traffic control (traffic lights); large-scale communication equipment; key financial terminal systems; safety control equipment; etc.
- Unless expressly designated as a high reliability product or a product for harsh environments in a Renesas Electronics data sheet or other Renesas Electronics document, Renesas Electronics products are not intended or authorized for use in products or systems that may pose a direct threat to human life or bodily injury (artificial life support devices or systems; surgical implantations; etc.), or may cause serious property damage (space system; undersea repeaters; nuclear power control systems; aircraft control systems; key plant systems; military equipment; etc.). Renesas Electronics disclaims any and all liability for any damages or losses incurred by you or any third parties arising from the use of any Renesas Electronics product that is inconsistent with any Renesas Electronics data sheet, user's manual or other Renesas Electronics document.
7. No semiconductor product is absolutely secure. Notwithstanding any security measures or features that may be implemented in Renesas Electronics hardware or software products, Renesas Electronics shall have absolutely no liability arising out of any vulnerability or security breach, including but not limited to any unauthorized access to or use of a Renesas Electronics product or a system that uses a Renesas Electronics product. RENESAS ELECTRONICS DOES NOT WARRANT OR GUARANTEE THAT RENESAS ELECTRONICS PRODUCTS, OR ANY SYSTEMS CREATED USING RENESAS ELECTRONICS PRODUCTS WILL BE INVULNERABLE OR FREE FROM CORRUPTION, ATTACK, VIRUSES, INTERFERENCE, HACKING, DATA LOSS OR THEFT, OR OTHER SECURITY INTRUSION ("Vulnerability Issues"). RENESAS ELECTRONICS DISCLAIMS ANY AND ALL RESPONSIBILITY OR LIABILITY ARISING FROM OR RELATED TO ANY VULNERABILITY ISSUES. FURTHERMORE, TO THE EXTENT PERMITTED BY APPLICABLE LAW, RENESAS ELECTRONICS DISCLAIMS ANY AND ALL WARRANTIES, EXPRESS OR IMPLIED, WITH RESPECT TO THIS DOCUMENT AND ANY RELATED OR ACCOMPANYING SOFTWARE OR HARDWARE, INCLUDING BUT NOT LIMITED TO THE IMPLIED WARRANTIES OF MERCHANTABILITY, OR FITNESS FOR A PARTICULAR PURPOSE.
 8. When using Renesas Electronics products, refer to the latest product information (data sheets, user's manuals, application notes, "General Notes for Handling and Using Semiconductor Devices" in the reliability handbook, etc.), and ensure that usage conditions are within the ranges specified by Renesas Electronics with respect to maximum ratings, operating power supply voltage range, heat dissipation characteristics, installation, etc. Renesas Electronics disclaims any and all liability for any malfunctions, failure or accident arising out of the use of Renesas Electronics products outside of such specified ranges.
 9. Although Renesas Electronics endeavors to improve the quality and reliability of Renesas Electronics products, semiconductor products have specific characteristics, such as the occurrence of failure at a certain rate and malfunctions under certain use conditions. Unless designated as a high reliability product or a product for harsh environments in a Renesas Electronics data sheet or other Renesas Electronics document, Renesas Electronics products are not subject to radiation resistance design. You are responsible for implementing safety measures to guard against the possibility of bodily injury, injury or damage caused by fire, and/or danger to the public in the event of a failure or malfunction of Renesas Electronics products, such as safety design for hardware and software, including but not limited to redundancy, fire control and malfunction prevention, appropriate treatment for aging degradation or any other appropriate measures. Because the evaluation of microcomputer software alone is very difficult and impractical, you are responsible for evaluating the safety of the final products or systems manufactured by you.
 10. Please contact a Renesas Electronics sales office for details as to environmental matters such as the environmental compatibility of each Renesas Electronics product. You are responsible for carefully and sufficiently investigating applicable laws and regulations that regulate the inclusion or use of controlled substances, including without limitation, the EU RoHS Directive, and using Renesas Electronics products in compliance with all these applicable laws and regulations. Renesas Electronics disclaims any and all liability for damages or losses occurring as a result of your noncompliance with applicable laws and regulations.
 11. Renesas Electronics products and technologies shall not be used for or incorporated into any products or systems whose manufacture, use, or sale is prohibited under any applicable domestic or foreign laws or regulations. You shall comply with any applicable export control laws and regulations promulgated and administered by the governments of any countries asserting jurisdiction over the parties or transactions.
 12. It is the responsibility of the buyer or distributor of Renesas Electronics products, or any other party who distributes, disposes of, or otherwise sells or transfers the product to a third party, to notify such third party in advance of the contents and conditions set forth in this document.
 13. This document shall not be reprinted, reproduced or duplicated in any form, in whole or in part, without prior written consent of Renesas Electronics.
 14. Please contact a Renesas Electronics sales office if you have any questions regarding the information contained in this document or Renesas Electronics products.

(Note1) "Renesas Electronics" as used in this document means Renesas Electronics Corporation and also includes its directly or indirectly controlled subsidiaries.

(Note2) "Renesas Electronics product(s)" means any product developed or manufactured by or for Renesas Electronics.

(Rev.5.0-1 October 2020)

Corporate Headquarters

TOYOSU FORESIA, 3-2-24 Toyosu,
Koto-ku, Tokyo 135-0061, Japan
www.renesas.com

Trademarks

Renesas and the Renesas logo are trademarks of Renesas Electronics Corporation. All trademarks and registered trademarks are the property of their respective owners.

Contact information

For further information on a product, technology, the most up-to-date version of a document, or your nearest sales office, please visit:
www.renesas.com/contact/