

LOC		DIST		REVISIONS			
ES	00	P	LTM	DESCRIPTION	DATE	DWN	APVD
	G2			ADDED THE DASH NO -27	11MAY2011	ML	SZ
	G3			REV PER ECR-13-006828	25APR2013	CZ	SZ
	G4			ADDED NEW DASH NUMBER 2-9	03JUN2013	CZ	SZ

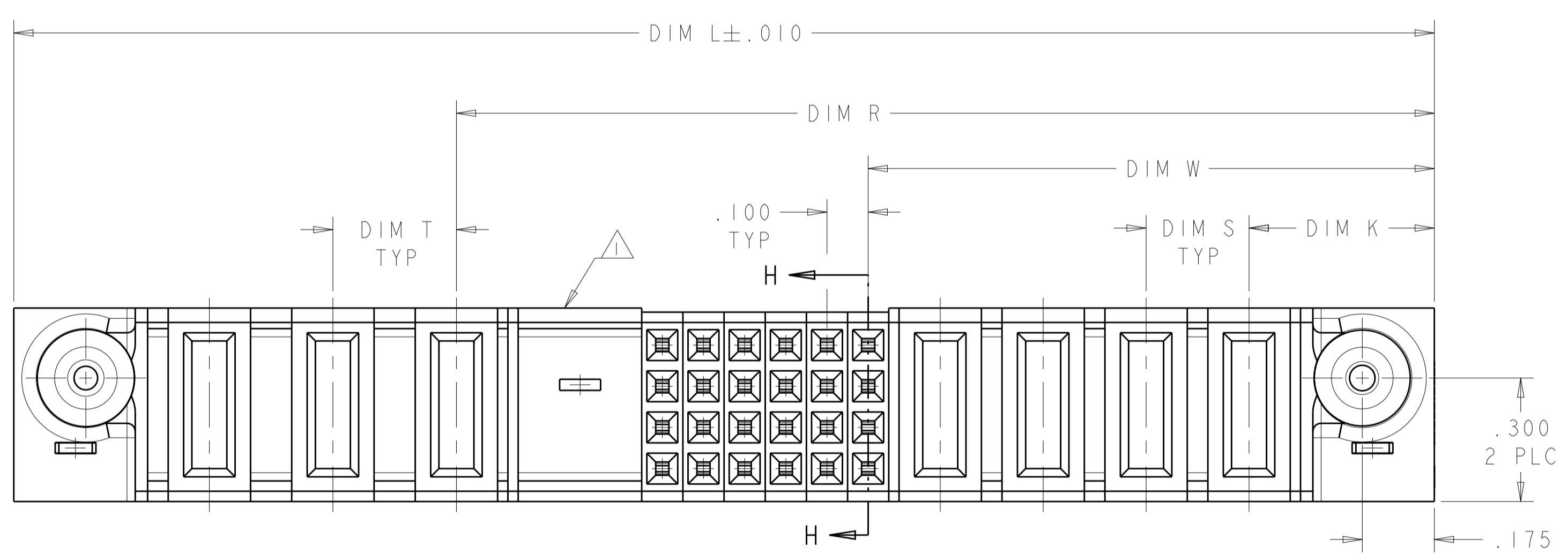

- △ OPTIONAL CENTER MODULE, WITH Ø.150 THRU HOLE OR HOLD DOWN FEATURE
- △ "AMP", TRADEMARK, PART NUMBER AND DATE CODE TO BE MARKED IN AREA SHOWN PARTS UNDER 2.00 LONG MAY BE MARKED ON BOTH SIDES
- △ MATERIAL: HOUSING - GLASS FILLED HIGH TEMP THERMO PLASTIC, UL94 V-0
 SIGNAL CONTACT - HIGH CONDUCTIVITY COPPER ALLOY
 POWER CONTACT - HIGH CONDUCTIVITY COPPER ALLOY
- △ CONTACT PLATING: NOBLE METAL PLATING ON CONTACT FUNCTIONAL AREA OF POWER AND SIGNAL CONTACTS
- △ MECHANICAL CONNECTOR KEEP OUT ZONE
- △ DATUM AND BASIC DIMENSIONS ESTABLISHED BY CUSTOMER
- △ PCB - ALL HOLE DIAMETERS ARE FINISHED HOLE SIZES
- △ PCB - .0453 ±.0010 DRILLED HOLES PLATED WITH .0003 MIN Sn OVER .001 TO .003 CU PLATING TO ACHIEVE A .040±.003 DIA HOLE
- △ FOR P/N:2-6450150-2.THE VARIABLE DIMENSIONS PLEASE SEE SHEET 7.

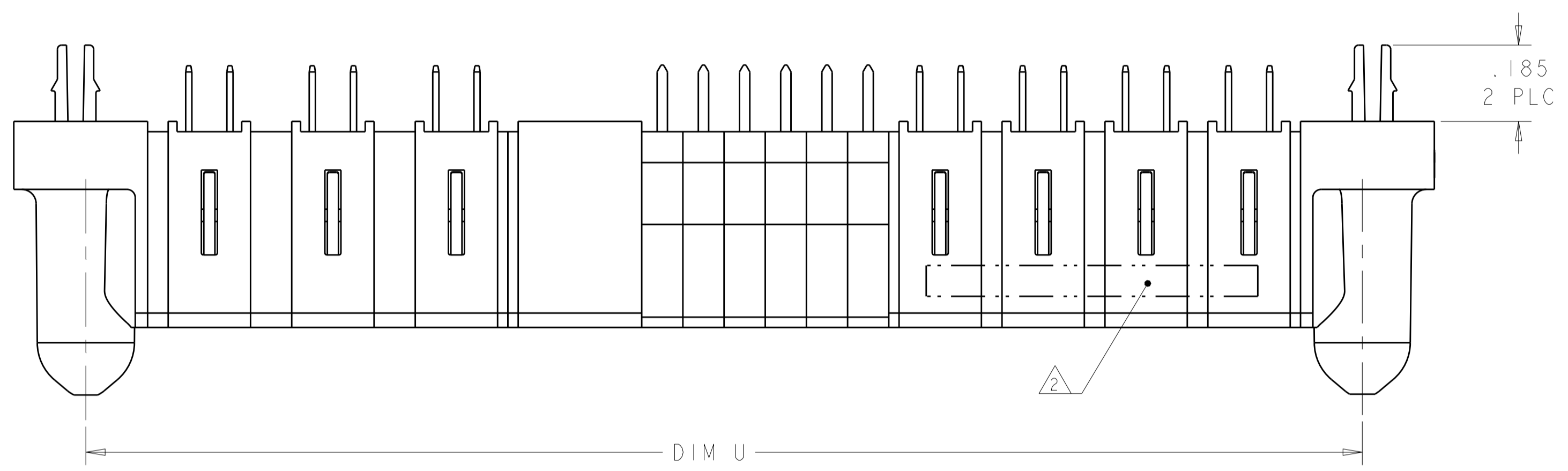
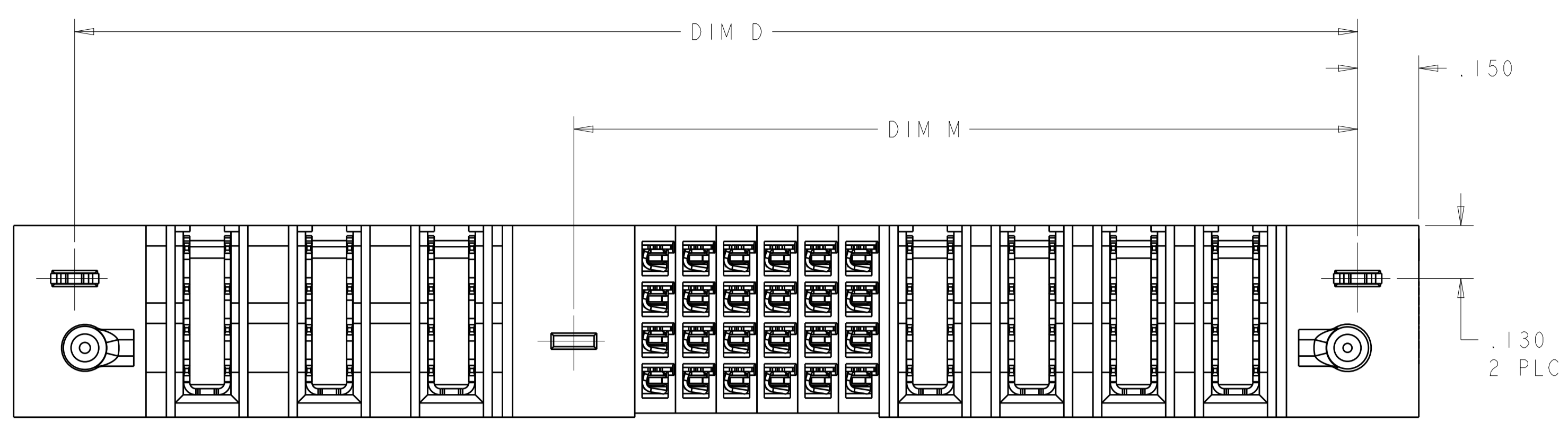
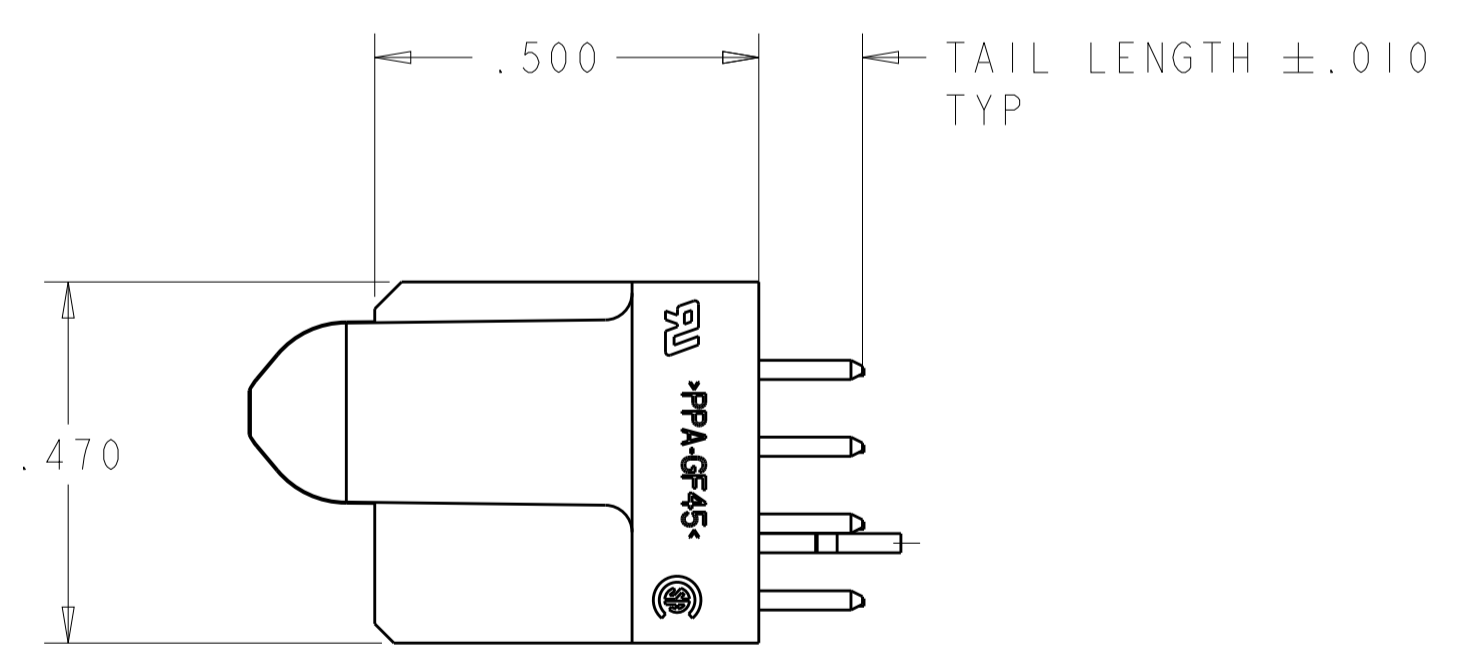
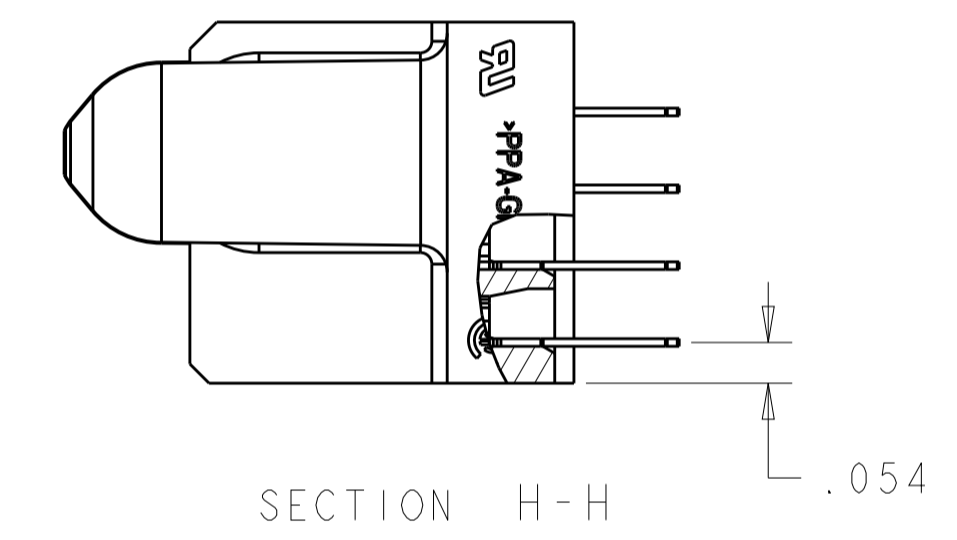

THIS DRAWING IS A CONTROLLED DOCUMENT.		DWN: R.GRZYBOWSKI 16FEB05	TE Connectivity
DIMENSIONS: INCHES		CHK: M.PERCHEKKE 16FEB05	
TOLERANCES UNLESS OTHERWISE SPECIFIED:		APVD: M.PERCHEKKE	NAME: VERTICAL RECEPTACLE ASSEMBLY WITH GUIDES MULTI-BEAM XL
0 PLC ±.01	1 PLC ±.01	PRODUCT SPEC: 108-1973	SIZE: A1
2 PLC ±.005	3 PLC ±.005	APPLICATION SPEC: 114-13038	CAGE CODE: 6450150
4 PLC ±.0020	ANGLES ±.7°	WEIGHT: -	RESTRICTED TO: -
MATERIAL: -	FINISH: -	CUSTOMER DRAWING	SCALE: 1:1 SHEET 1 OF 12 REV: G5

THIS DRAWING IS UNPUBLISHED. RELEASED FOR PUBLICATION
 BY - ALL RIGHTS RESERVED.

LOC	DIST	REVISIONS					
		P	LTN	DESCRIPTION	DATE	DWN	APVD
ES	00	-		SEE SHEET 1	-	-	-

WITH	2.650	.200	.250	1.550	.875	2.700	-	3.000	.450	2P + 24S + 6P	2-6450150-9
WITH	2.300	.250	.300	1.950	1.275	2.350	-	2.650	.475	3ACP + 24S + 2P	2-6450150-8
WITH	5.150	.300	.300	3.550	2.700	5.200	-	5.500	.450	8ACP + 32S + 6ACP	2-6450150-7
WITH	2.800	.300	.250	2.075	1.375	2.850	-	3.150	.450	4P + 24S + 3ACP	2-6450150-6
WITH	3.800	.300	.250	1.875	1.375	3.850	-	4.150	.450	4P + 16S + 7ACP	2-6450150-5
WITH	2.400	.200	.200	2.100	.825	2.450	-	2.750	.450	2P + 48S + 2P	2-6450150-4
WITH	1.700	.250	.250	1.350	.875	1.750	-	2.050	.450	2P + 16S + 2P	2-6450150-3
WITHOUT	5.500	.300	.300	3.175	2.525	5.550	-	5.850	.475	7ACP+20S+4ACP+5P	2-6450150-2
WITH	2.900	.250	.250	2.550	.875	2.950	-	3.250	.450	2P + 64S + 2P	2-6450150-1
WITH	3.550	-	.300	2.550	1.275	3.600	-	3.900	.475	3ACP + 48S + 5P	2-6450150-0
WITH	4.000	-	-	-	.375	4.050	-	4.350	-	148S	1-6450150-9
WITH	2.800	.250	.250	1.700	1.125	2.850	-	3.150	.450	3P + 20S + 5P	1-6450150-8
WITH	2.200	.250	.250	1.350	.875	2.250	-	2.550	.450	2P + 16S + 4P	1-6450150-7
WITH	3.500	.300	.250	2.775	2.375	3.550	-	3.850	.450	8P + 12S + 3ACP	1-6450150-3
WITH	2.300	.250	.300	1.950	1.275	2.350	-	2.650	.475	3ACP + 24S + 2P	6450150-9
WITH	1.575	-	-	1.425	.700	1.625	-	1.925	.475	1P + 24S + 1P	6450150-8
WITH	3.000	.250	.250	2.150	1.425	3.050	-	3.350	.450	4P + 24S + 4P	6450150-6
WITH	2.500	.300	.250	1.800	1.125	2.550	-	2.850	.450	3P + 24S + 3ACP	6450150-5
WITH	2.675	.200	.200	2.375	1.650	2.725	-	3.025	.475	5P + 24S + 2P	6450150-4
WITH	2.800	.300	.250	2.075	1.375	2.850	-	3.150	.450	4P + 24S + 3ACP	6450150-3
WITH	3.550	-	.300	2.550	1.275	3.600	-	3.900	.475	3ACP + 48S + 5P	6450150-2
WITH	4.350	.250	.250	3.500	2.625	4.400	-	4.700	.450	9P + 32S + 4P	6450150-1
HOLD DOWN	U	T	S	R	W	D	M	L	K	DESCRIPTION	PART NUMBER

THIS DRAWING IS A CONTROLLED DOCUMENT.		OWN R. GRZYBOWSKI	16FEB05		TE Connectivity	
DIMENSIONS: INCHES		CHK M. PERCHERKE	16FEB05		NAME	
TOLERANCES UNLESS OTHERWISE SPECIFIED:		APVD M. PERCHERKE		PRODUCT SPEC		
0 PLC ±.01		PRODUCT SPEC		VERTICAL RECEPTACLE ASSEMBLY WITH GUIDES		
2 PLC ±.01		APPLICATION SPEC		MULTI-BEAM XL		
3 PLC ±.005		SIZE		CAGE CODE		
4 PLC ±.0020		DRAWING NO		DRAWING NO		
ANGLES ±.0020		RESTRICTED TO		A100779		
FINISH		WEIGHT		C=6450150		
MATERIAL		CUSTOMER DRAWING		SCALE 1:1		
				SHEET 2 OF 12		
				REV G5		

PART NUMBER	ROWS	POWER (L)						SIGNAL						POWER (R)															
		P7	P6	6	5	4	3	2	1	P5	P4	P3	P2	P1	P1	P2	P3	P4	P5	P6	P7								
6450150-4	D							J	J	J	J	J	J	VN	VN	VN	VN												
	C							J	J	J	J	J	J	VN	VN	VN	VN												
	B							J	J	J	J	J	J	VN	VN	VN	VN												
		HD																										HD	
		5P + 24S + 2P																											

PART NUMBER	ROWS	POWER (L)						SIGNAL						POWER (R)															
		P8	P7	P6	P5	6	5	4	3	2	1	P4	P3	P2	P1														
6450150-6	D							J	J	J	J	J	J	VN	VN	VN	VN												
	C							J	J	J	J	J	J	VN	VN	VN	VN												
	B							J	J	J	J	J	J	VN	VN	VN	VN												
		HD																										HD	
		4P + 24S + 4P																											

NO CONTACT
LOADED

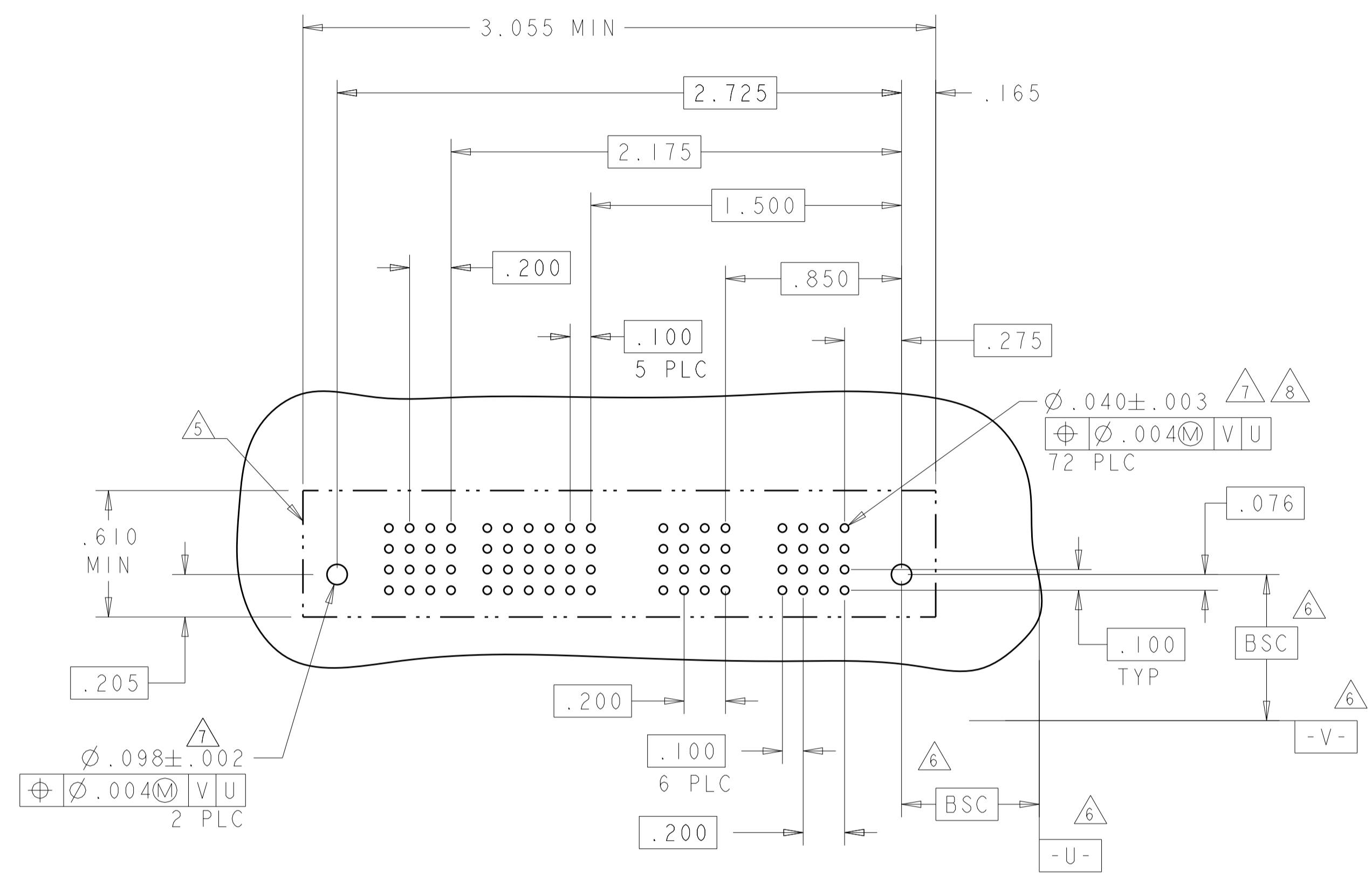

PART NUMBER	ROWS	POWER (L)						SIGNAL						POWER (R)															
		P6	P5	P4	6	5	4	3	2	1	P3	P2	P1	P1	P2	P3	P4	P5	P6										
6450150-5	D							E	E	E	E	E	E	VM	VM	VM	VM												
	C							E	E	E	E	E	E	VM	VM	VM	VM												
	B							E	E	E	E	E	E	VM	VM	VM	VM												
		HD																										HD	
		3P + 24S + 3ACP																											

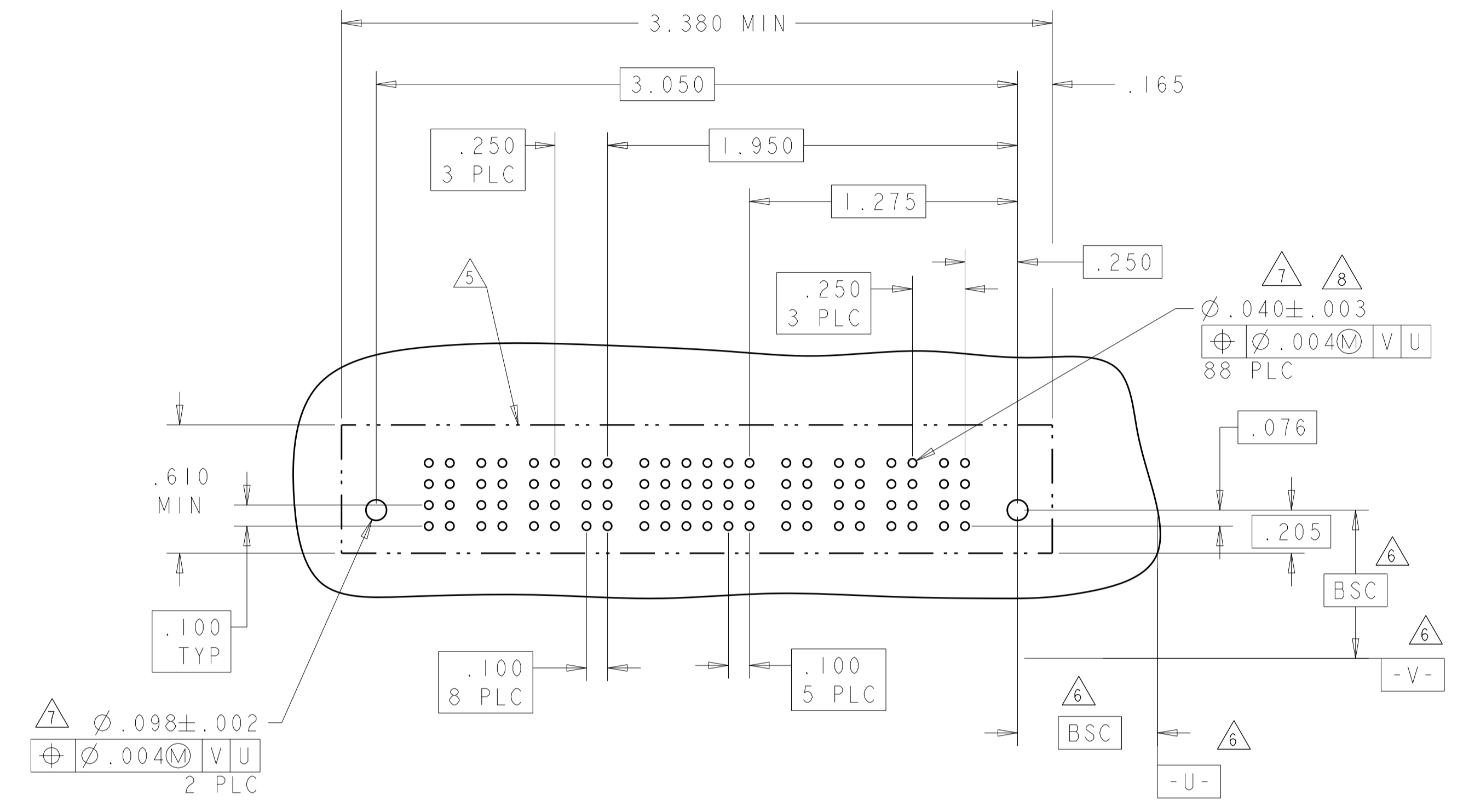

PART NUMBER	ROWS	POWER (L)						SIGNAL						POWER (R)															
		P2	6	5	4	3	2	1	P1	P2	P1	P2	P1	P1	P2	P3	P4	P5	P6										
6450150-8	D							E	E	E	E	E	E	VM	VM	VM	VM												
	C							E	E	E	E	E	E	VM	VM	VM	VM												
	B							E	E	E	E	E	E	VM	VM	VM	VM												
		HD																										HD	
		1P + 24S + 1P																											

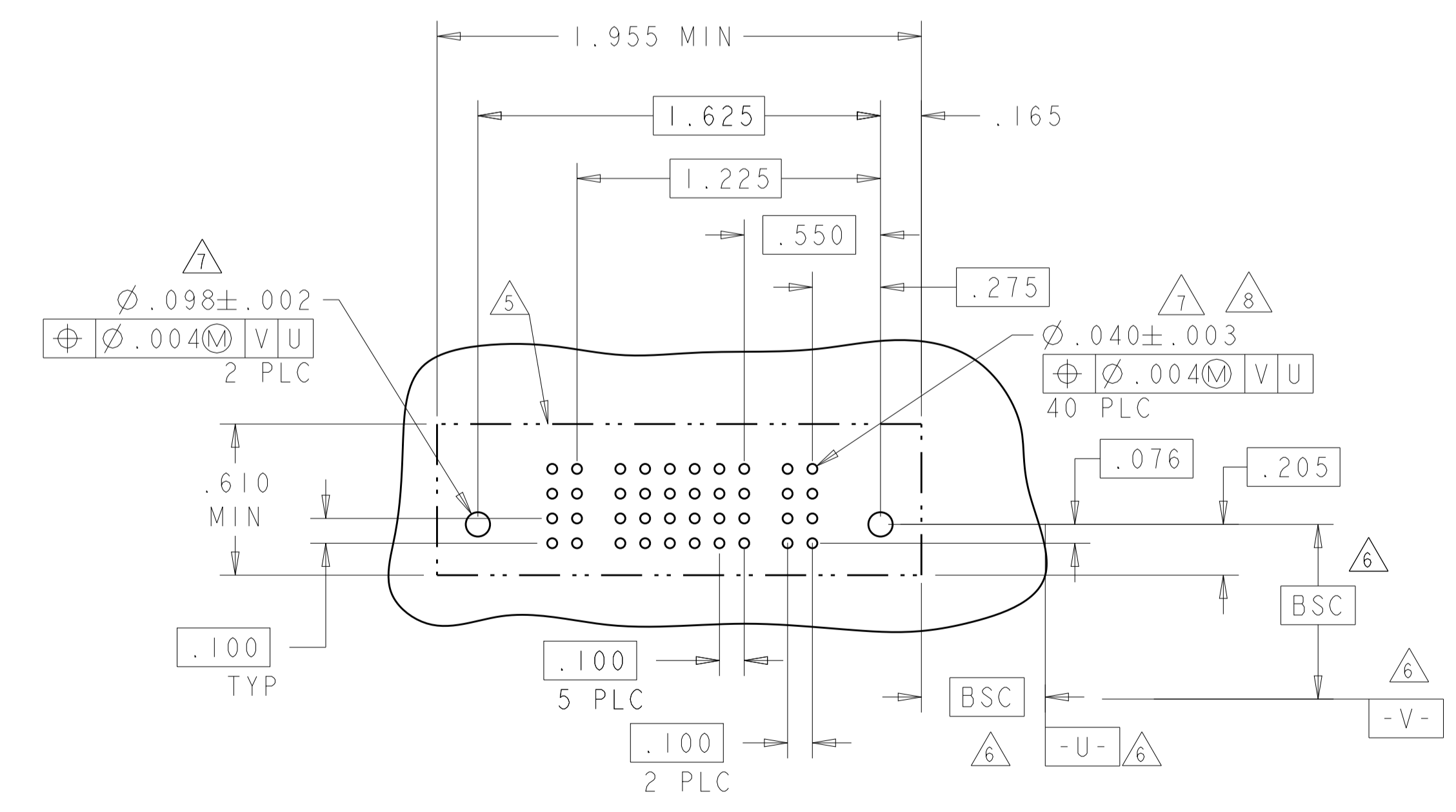
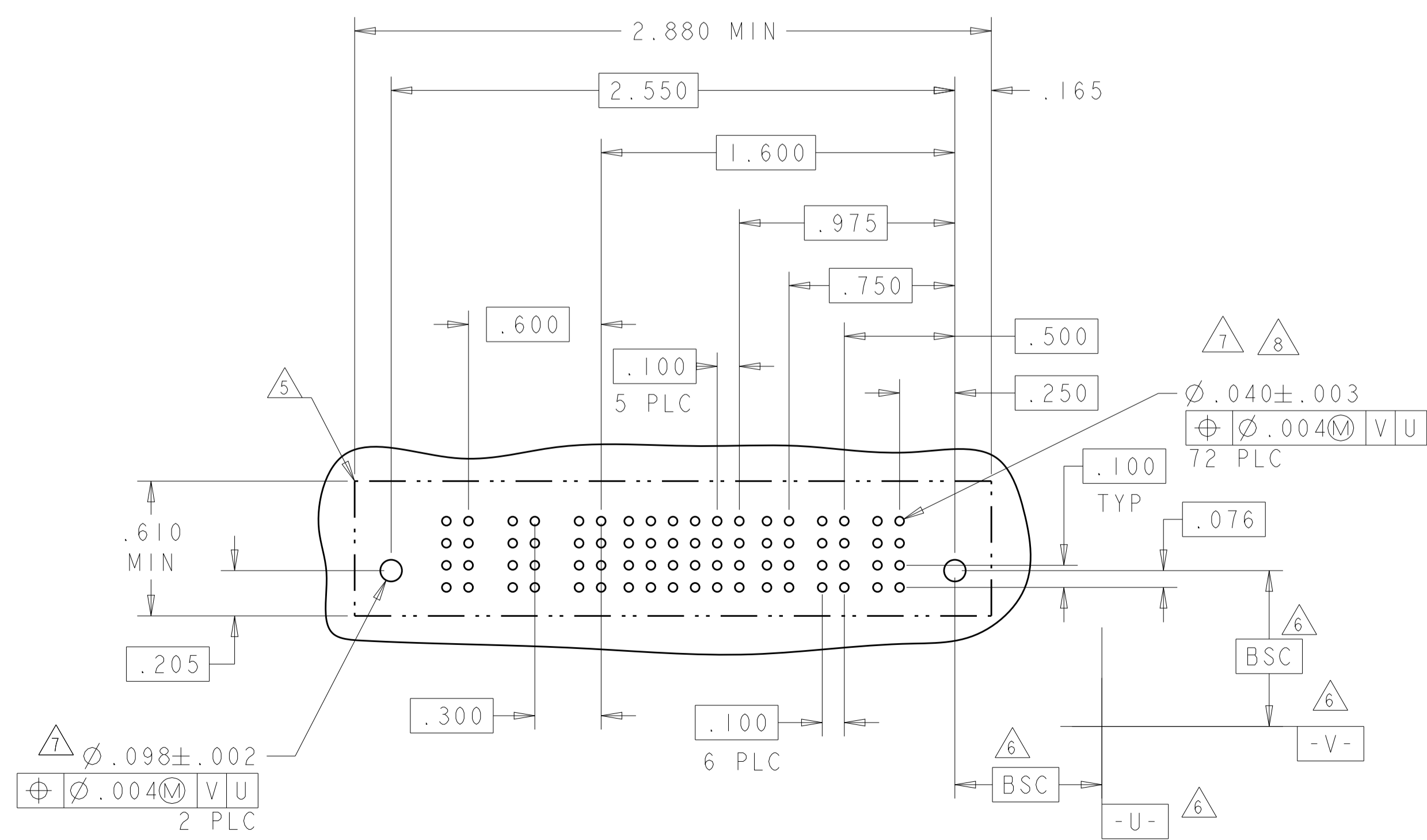

THIS DRAWING IS A CONTROLLED DOCUMENT.		DWN: R. GRZYBOWSKI 16FEB05		TE Connectivity
DIMENSIONS: INCHES		CHK: M. PERCHERKE 16FEB05		NAME: VERTICAL RECEPTACLE ASSEMBLY WITH GUIDES MULTI-BEAM XL
TOLERANCES UNLESS OTHERWISE SPECIFIED:		APVD: M. PERCHERKE	PRODUCT SPEC: 108-1973	
0 PLC ±.01		PRODUCT SPEC: 108-1973	APPLICATION SPEC: 114-13038	
1 PLC ±.005		SIZE: 114-13038	WEIGHT: A100779	
2 PLC ±.002		SCALE: 1:1	SHEET 4 OF 12	
ANGLES ±.002		CUSTOMER DRAWING	REV: G5	

LOC	DIST	REVISIONS			
ES	00	REV	DATE	BY	APPV
		1	SEE SHEET 1		

PART NUMBER	ROWS	POWER (L)		SIGNAL																POWER (R)							
		P4	P3	16	15	14	13	12	11	10	9	8	7	6	5	4	3	2	1	P2	P1						
2-6450150-1	D C B A	○ HD	VB	VN	J	J	J	J	J	J	J	J	J	J	J	J	J	J	J	J	J	J	VN	VB	○ HD		
					J	J	J	J	J	J	J	J	J	J	J	J	J	J	J	J	J	J				J	
					J	J	J	J	J	J	J	J	J	J	J	J	J	J	J	J	J	J				J	J
					J	J	J	J	J	J	J	J	J	J	J	J	J	J	J	J	J	J				J	J
2P + 64S + 2P																											

PART NUMBER	ROWS	POWER		SIGNAL						POWER																		
		P5	P4	6	5	4	3	2	1	P3	P2	P1																
6450150-9	D C B A	○ HD	VM	VM	E	E	E	E	E	E	E	E	E	E	E	E	E	E	E	E	E	E	VA	VM	VM	○ HD		
					E	E	E	E	E	E	E	E	E	E	E	E	E	E	E	E	E	E					E	
					E	E	E	E	E	E	E	E	E	E	E	E	E	E	E	E	E	E					E	E
					E	E	E	E	E	E	E	E	E	E	E	E	E	E	E	E	E	E					E	E
3ACP+24S+2P																												

PART NUMBER	ROWS	POWER		SIGNAL						POWER																		
		P5	P4	6	5	4	3	2	1	P3	P2	P1																
2-6450150-8	D C B A	○ HD	VM	VM	E	E	E	E	E	E	E	E	E	E	E	E	E	E	E	E	E	E	VA	VM	VM	○ HD		
					E	E	E	E	E	E	E	E	E	E	E	E	E	E	E	E	E	E					E	
					E	E	E	E	E	E	E	E	E	E	E	E	E	E	E	E	E	E					E	E
					E	E	E	E	E	E	E	E	E	E	E	E	E	E	E	E	E	E					E	E
3ACP+24S+2P																												

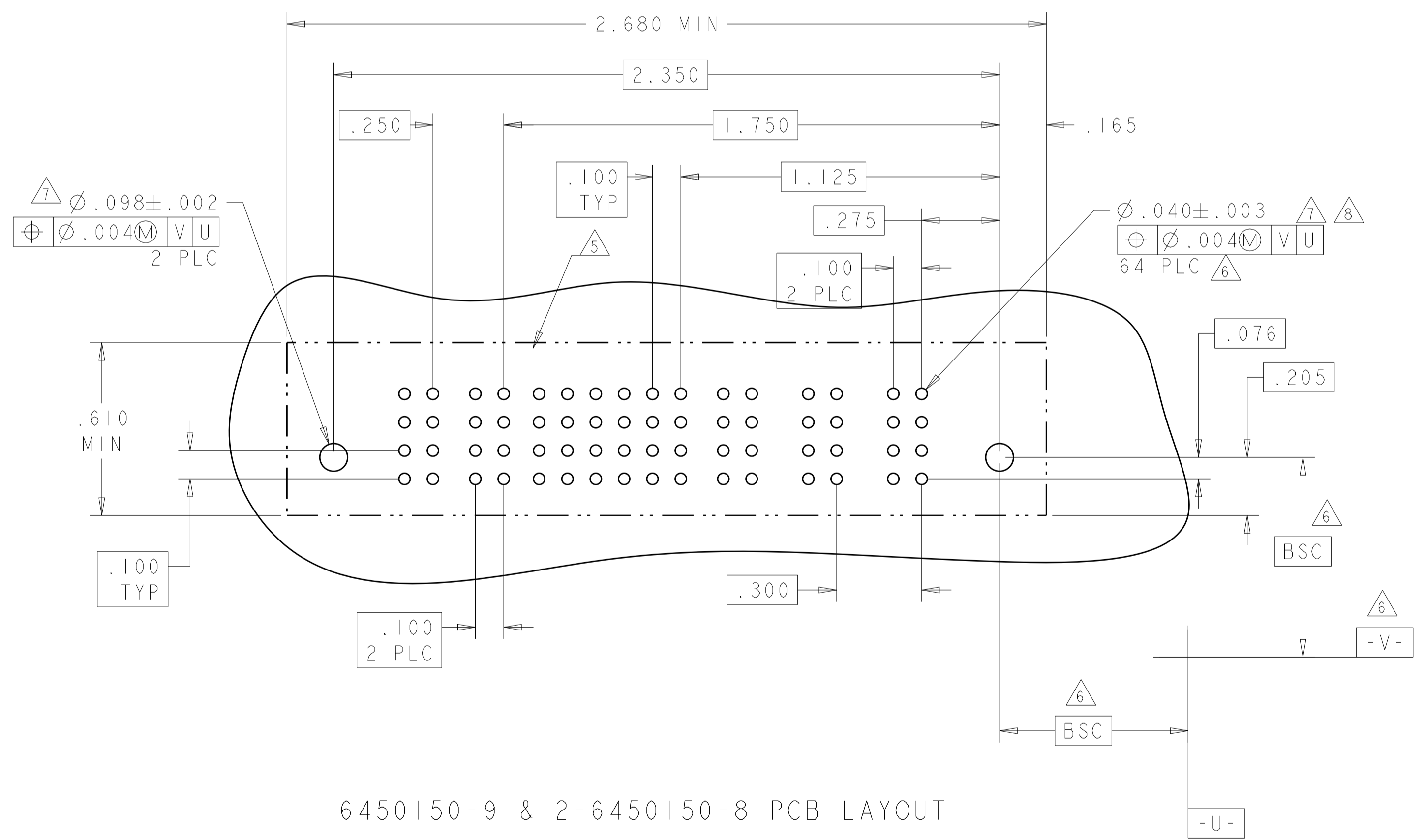
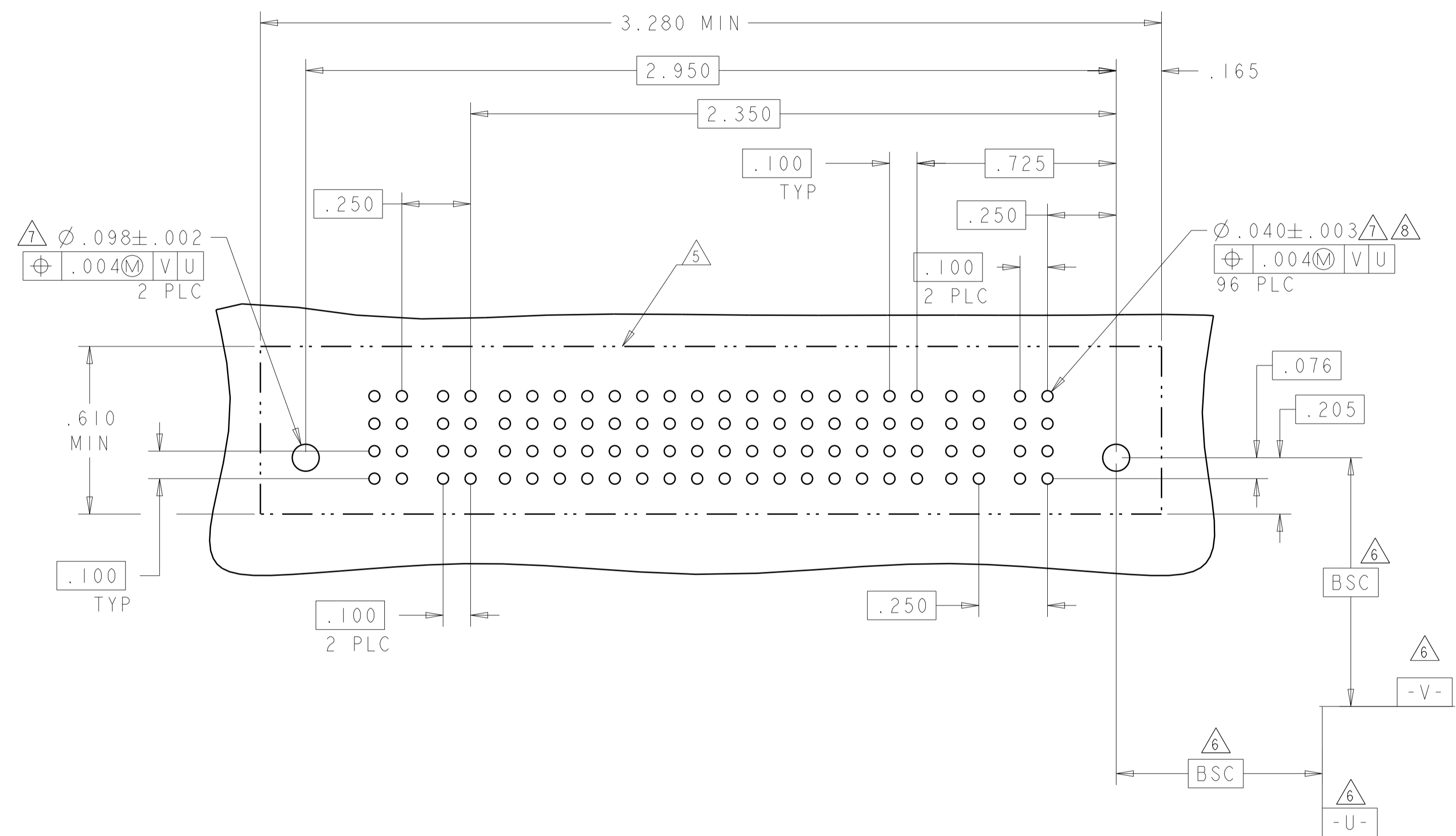

6450150-9 & 2-6450150-8 PCB LAYOUT

THIS DRAWING IS A CONTROLLED DOCUMENT.		OWN: R. GRZYBOWSKI 16FEB05	STE TE Connectivity
DIMENSIONS: INCHES		CHK: M. PERCHERKE 16FEB05	
TOLERANCES UNLESS OTHERWISE SPECIFIED:		APVD: M. PERCHERKE	NAME: VERTICAL RECEPTACLE ASSEMBLY WITH GUIDES MULTI-BEAM XL
0 PLC ±.01		PRODUCT SPEC: 108-1973	SIZE: A1
1 PLC ±.01		APPLICATION SPEC: 114-13038	CAGE CODE: 6450150
2 PLC ±.01		WEIGHT: -	SCALE: 1:1
3 PLC ±.005		CUSTOMER DRAWING	SHEET 7 OF 12
4 PLC ±.0020			REV: G5
ANGLES ±.020			
FINISH: -			

LOC		DIST		REVISIONS			
ES	00	P	LTN	DESCRIPTION	DATE	DWN	APVD
-	-	-	-	SEE SHEET 1	-	-	-

NO CONTACTS LOADED

PART NUMBER	ROWS	POWER (L)								SIGNAL					POWER (R)							
		P16	P15	P14	P13	P12	P11	P10	P9	P8	5	4	3	2	1	P7	P6	P5	P4	P3	P2	P1
2-6450150-2	D C B A	VA		VM		VM	VM	VM	VM	VM	E	E	E	E	E	VM	VM	VM	VM	VM	VM	VM
											E	E	E	E	E							
											E	E	E	E	E							

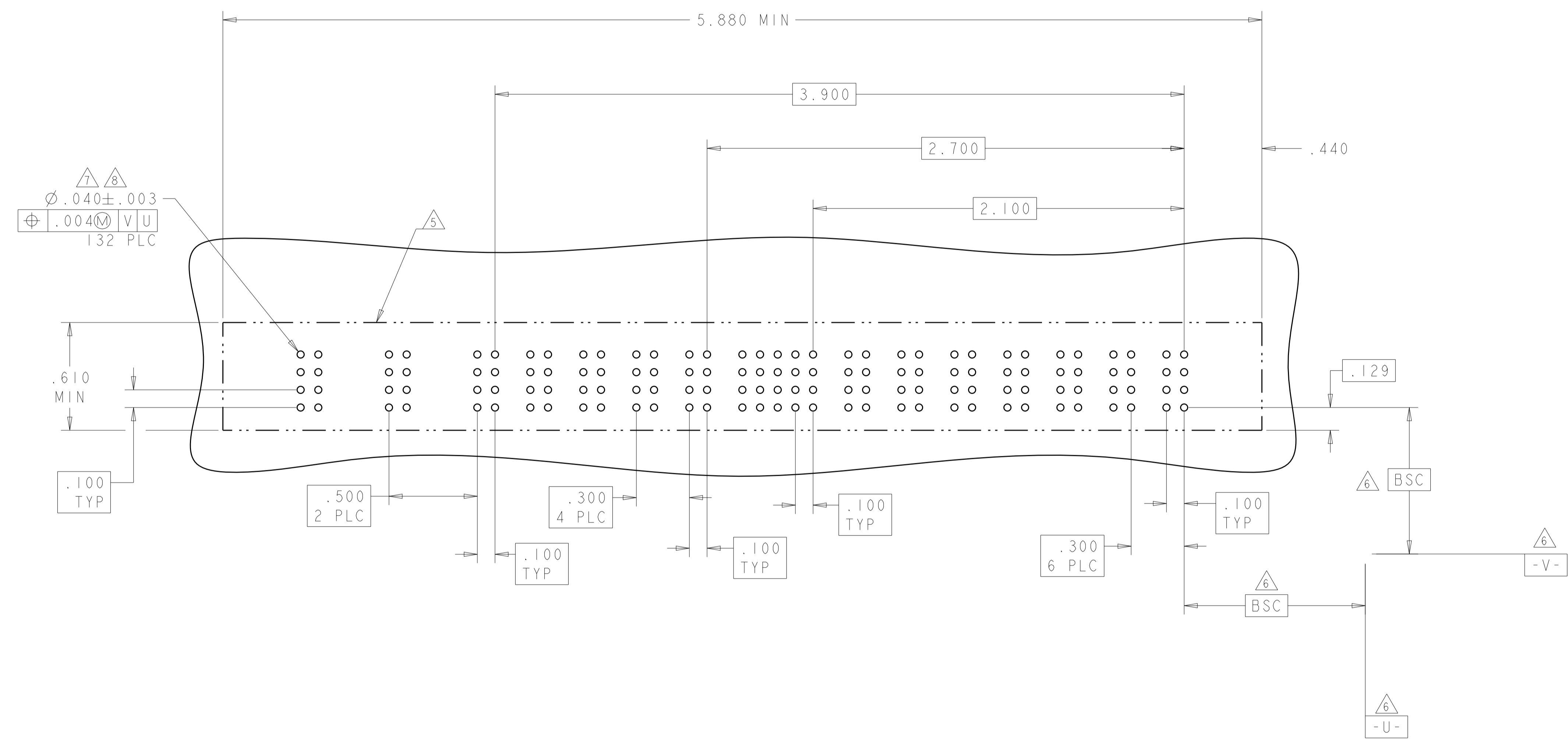
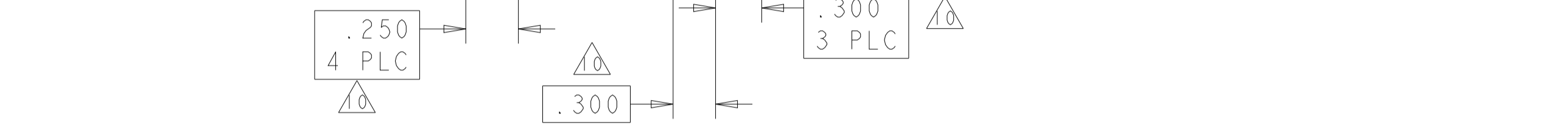

THIS DRAWING IS A CONTROLLED DOCUMENT.		DWN: R. GRZYBOWSKI 16FEB05	TE Connectivity
DIMENSIONS: INCHES		CHK: M. PERCHERKE 16FEB05	
TOLERANCES UNLESS OTHERWISE SPECIFIED: 0 PLC ±. 1 PLC ±.01 2 PLC ±.01 3 PLC ±.005 4 PLC ±.0020 ANGLES ±.2°		APVD: M. PERCHERKE	NAME: VERTICAL RECEPTACLE ASSEMBLY WITH GUIDES MULTI-BEAM XL
MATERIAL: -		FINISH: -	RESTRICTED TO: -
CUSTOMER DRAWING		SCALE: 1:1	SHEET 8 OF 12 REV G5

LOC	DIST	REVISIONS			
P	LTN	DESCRIPTION	DATE	OWN	APVD
-	-	SEE SHEET 1	-	-	-

PART NUMBER	ROWS	POWER		SIGNAL				POWER	
		P4	P3	4	3	2	1	P2	P1
2-6450150-3	D	VM	VM	E	E	E	E	VA	VA
	C			E	E	E	E		
	B			E	E	E	E		
	A			E	E	E	E		
2P + 16S + 2P		HD						HD	

PART NUMBER	ROWS	POWER		SIGNAL												POWER					
		P4	P3	12	11	10	9	8	7	6	5	4	3	2	1	P2	P1				
2-6450150-4	D	VM	VA	E	E	E	E	E	E	E	E	E	E	E	E	E	E	E	VA	VM	
	C			E	E	E	E	E	E	E	E	E	E	E	E	E	E	E			
	B			E	E	E	E	E	E	E	E	E	E	E	E	E	E	E			E
	A			E	E	E	E	E	E	E	E	E	E	E	E	E	E	E			E
2P + 48S + 2P		HD														HD					

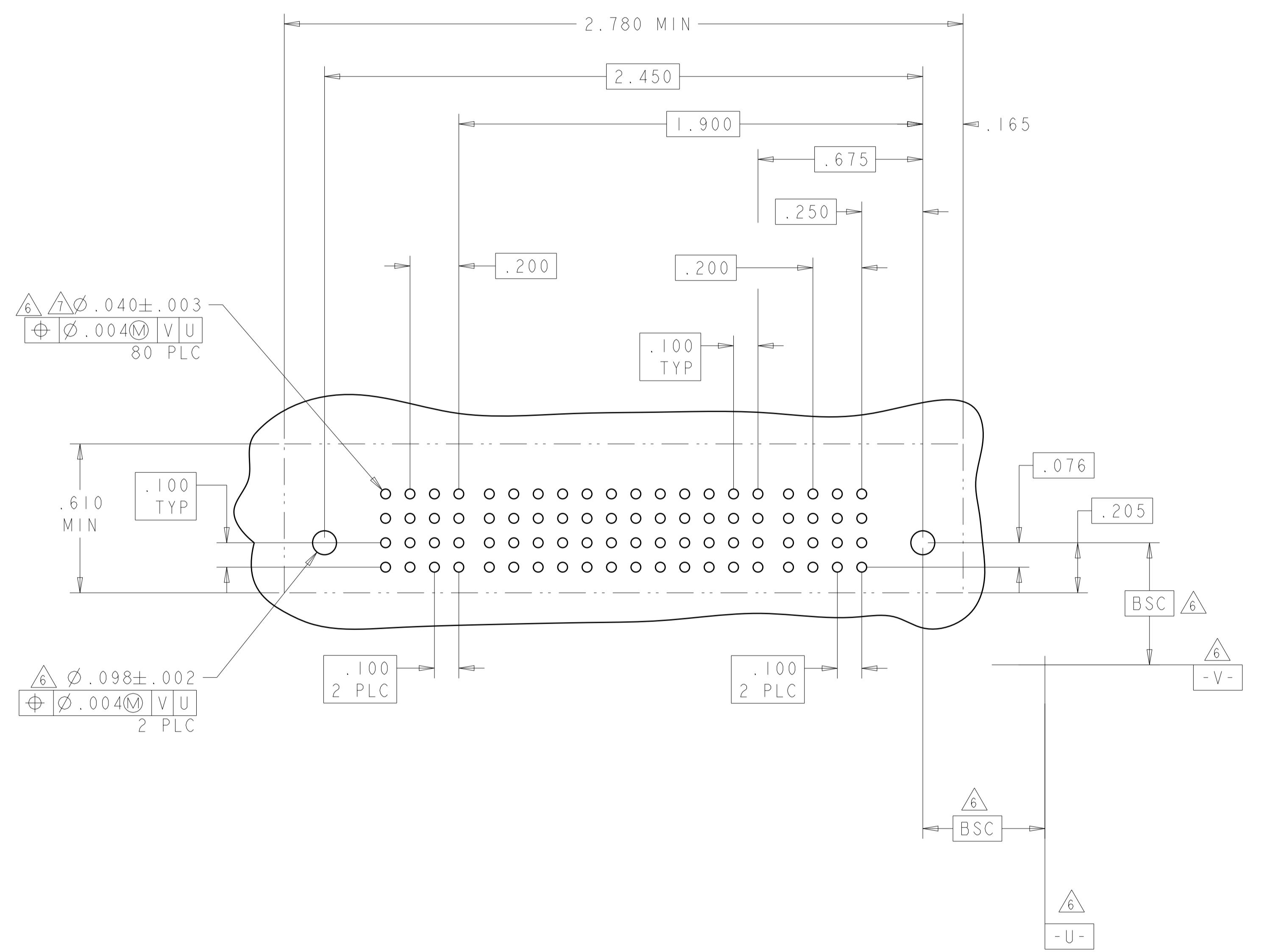
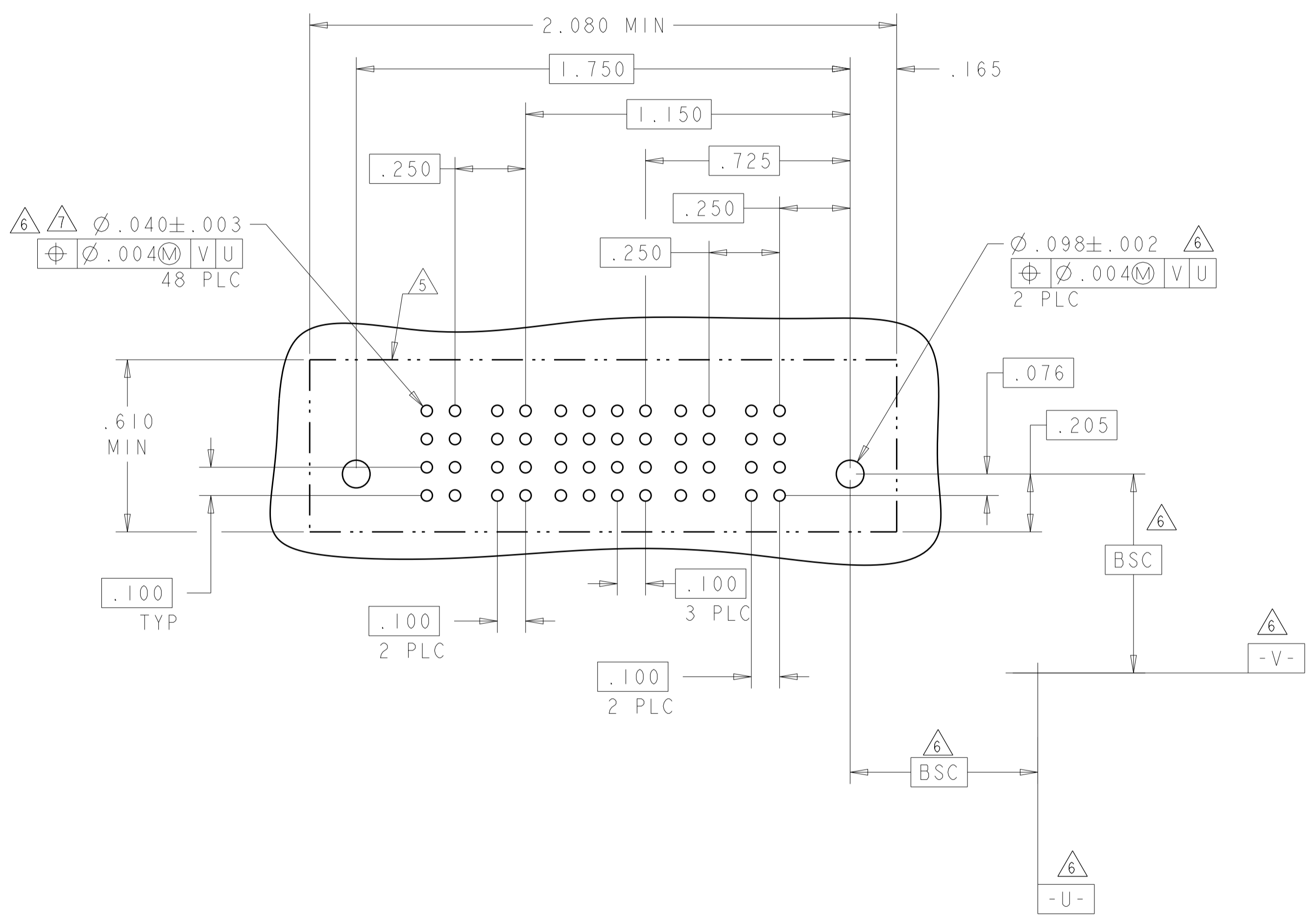

THIS DRAWING IS A CONTROLLED DOCUMENT.

DIMENSIONS: INCHES	TOLERANCES UNLESS OTHERWISE SPECIFIED: 0 PLC ±. 2 PLC ±.01 3 PLC ±.005 4 PLC ±.0020 ANGLES ±.2°	FINISH	OWN: R. GRZYBOWSKI 16FEB05 CHK: M. PERCHERKE 16FEB05 APVD: M. PERCHERKE	NAME: VERTICAL RECEPTACLE ASSEMBLY WITH GUIDES MULTI-BEAM XL
MATERIAL	FINISH	WEIGHT	PRODUCT SPEC: 108-1973 APPLICATION SPEC: 114-13038	RESTRICTED TO: -
CUSTOMER DRAWING			SCALE: 1:1	SHEET 9 OF 12 REV G5

LOC	DIST	REVISIONS			
		REV	DATE	BY	APPD
ES	00	-	SEE SHEET 1	-	-

PART NUMBER	ROWS	POWER						SIGNAL							
		P8	P7	P6	P5	P4	P3	4	3	2	3	2	1	P2	P1
2-6450150-9	D							E	E	E	E	E			
	C							E	E	E	E	E	VM	VM	
	B							E	E	E	E	E			
	A	HD						E	E	E	E	E			

NO CONTACTS LOADED (pointing to P8, P7, P6, P5, P4, P3)
 NO CONTACTS LOADED (pointing to P2, P1)

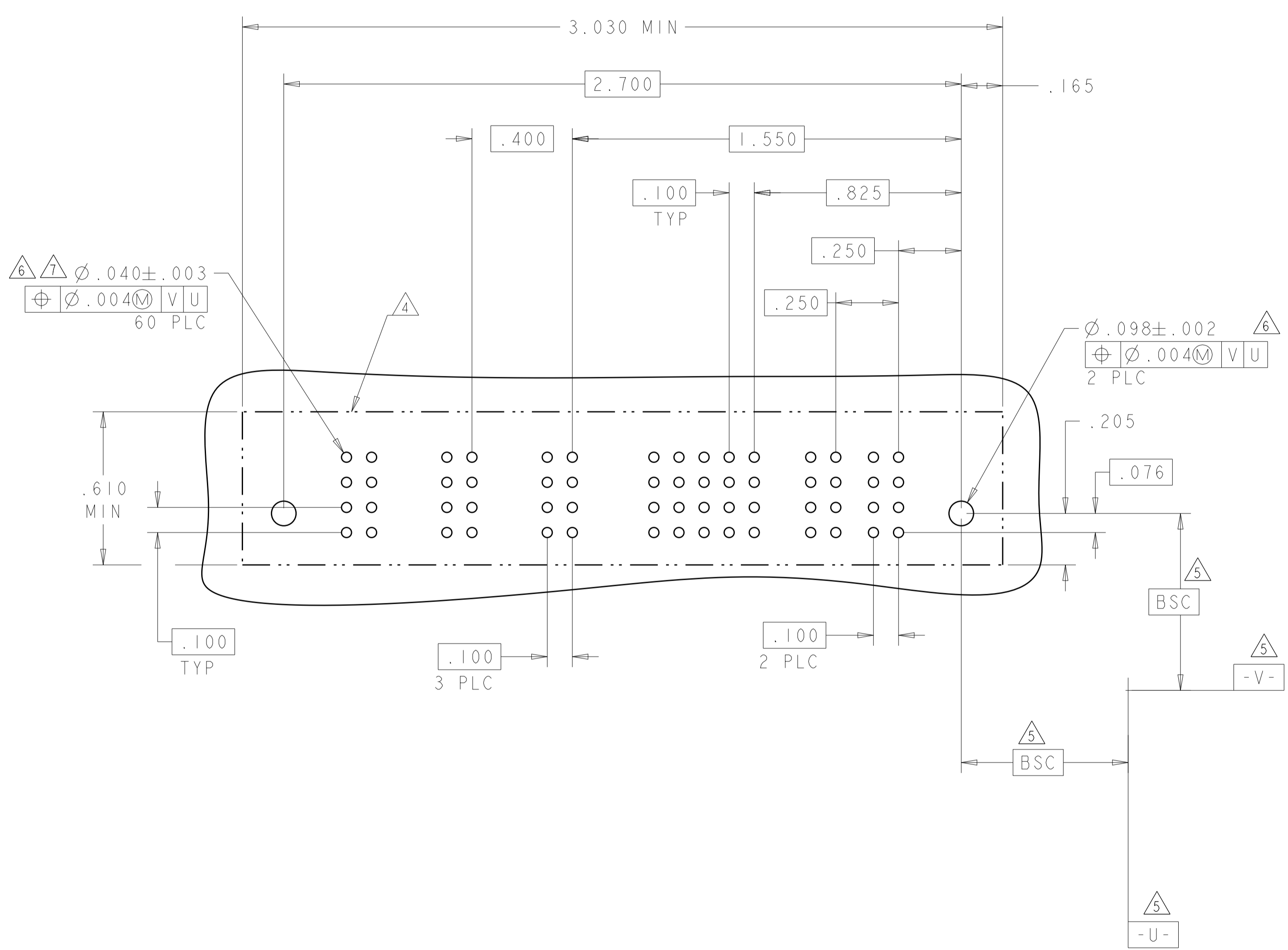

THIS DRAWING IS A CONTROLLED DOCUMENT.		DWN: R. GRZYBOWSKI 16FEB05 CHK: M. PERCHERKE 16FEB05 APVD: M. PERCHERKE	TE Connectivity
DIMENSIONS: INCHES TOLERANCES UNLESS OTHERWISE SPECIFIED: 0 PLC ±. 1 PLC ±.01 2 PLC ±.01 3 PLC ±.005 4 PLC ±.0020 ANGLES ±.2°		NAME: VERTICAL RECEPTACLE ASSEMBLY WITH GUIDES MULTI-BEAM XL PRODUCT SPEC: 108-1973 APPLICATION SPEC: 114-13038 WEIGHT: - CUSTOMER DRAWING	
MATERIAL: -		SIZE: A1 CAGE CODE: 00779 DRAWING NO: C=6450150	RESTRICTED TO: - SCALE: 1:1 SHEET: 12 OF 12 REV: G5