

**SERIES:** PSK-60 | **DESCRIPTION:** INTERNAL AC-DC POWER SUPPLY

**FEATURES**

- universal input voltage range (85~264 VAC)
- IEC/EN/UL 62368 certified
- meets CISPR32/EN 55032 Class B without external components
- 4,000 VAC isolation rating
- short-circuit, over-current, over-voltage protections

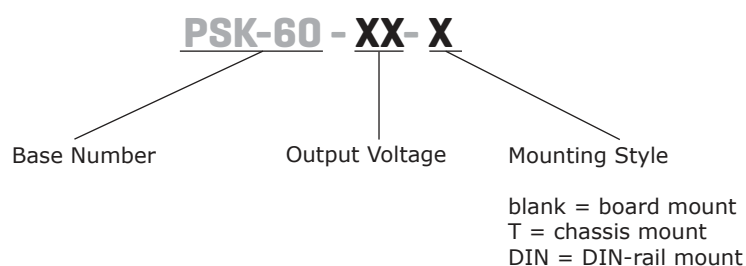

MODEL	output voltage	output current max	output power max	ripple and noise max	efficiency
	(Vdc)	(A)	(W)	(mVp-p)	typ (%)
PSK-60-5	5	10.0	50	120	84
PSK-60-12	12	5.0	60	120	87
PSK-60-15	15	4.0	60	120	88
PSK-60-24	24	2.5	60	120	89
PSK-60-48	48	1.25	60	120	90

**PART NUMBER KEY**

## INPUT

parameter	conditions/description	min	typ	max	units
voltage	ac input	85		264	Vac
	dc input	100		370	Vdc
frequency		47		63	Hz
current	at 115 Vac			1.8	A
	at 230 Vac			1.0	A
inrush current	at 115 Vac at 230 Vac		45 90		A
no load power consumption	at 230 Vac			0.5	W

## OUTPUT

parameter	conditions/description	min	typ	max	units
capacitive load	5 Vdc output			20,000	μF
	12 Vdc output			4,000	
	15 Vdc output			3,000	
	24 Vdc output			1,800	
	48 Vdc output			470	
initial set point accuracy	at full load		±2		%
line regulation	rated load		±0.5		%
load regulation	0%~100% load		±1.0		%
hold-up time	at 115 Vac		8		ms
	at 230 Vac		65		
temperature coefficient			±0.02		%/°C

## PROTECTIONS

parameter	conditions/description	min	typ	max	units
over voltage protection	5 Vdc output, clamp			9	Vdc
	12 Vdc output, clamp			16	
	15 Vdc output, clamp			25	
	24 Vdc output, clamp			35	
	48 Vdc output, clamp			60	
over current protection	auto recovery	110			%
short circuit protection	hiccup, continuous, auto recovery				

## SAFETY & COMPLIANCE

parameter	conditions/description	min	typ	max	units
isolation voltage	input to output	4,000			Vac
safety approvals	UL/cUL, EN, IEC 62368				
safety class	Class II				
EMI/EMC	CISPR 32/EN 55032 Class B				
ESD	IEC/EN 61000-4-2 Contact ±6KV/Air ±8KV, perf. Criteria B				
radiated immunity	IEC/EN 61000-4-3 10 V/m, perf. Criteria A				
EFT/burst	IEC/EN 61000-4-4 ±4KV, perf. Criteria B				
surge	IEC/EN 61000-4-5 line to line ±2KV/line to ground ±4KV, perf. Criteria B (see recommended EMC circuit)				
	IEC/EN 61000-4-5 ±1KV line to line, perf. Criteria B				
conducted immunity	IEC/EN 61000-4-6 10 Vr.m.s, perf. Criteria A				
voltage dips and interruption	IEC/EN 61000-4-11 0%, 70%, perf. Criterial B				
MTBF	per MIL-HDBK-217F at 25 °C	300,000			hours
RoHS	yes				

## DERATING CURVES

**TEMPERATURE DERATING CURVE**

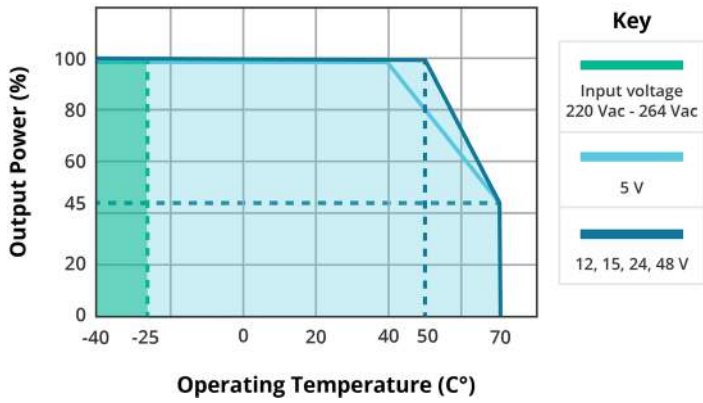

**INPUT VOLTAGE DERATING CURVE (25 °C)**

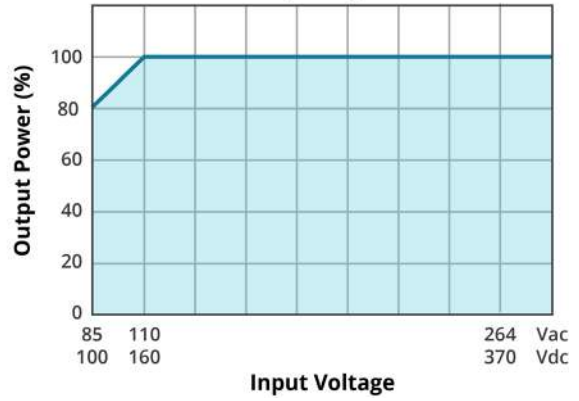

## EFFICIENCY CURVES

**EFFICIENCY VS INPUT VOLTAGE (Full load)**

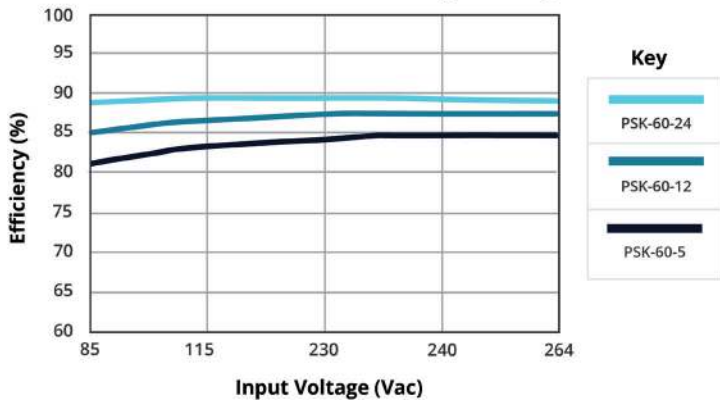

**EFFICIENCY VS OUTPUT LOAD (Vin = 230 Vac)**

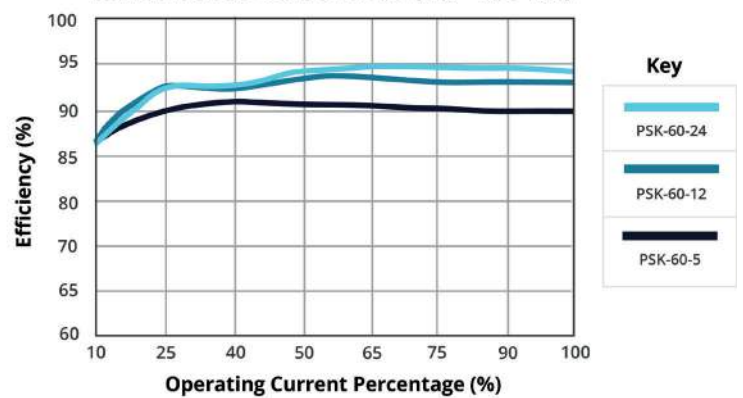

## ENVIRONMENTAL

parameter	conditions/description	min	typ	max	units
operating temperature		-40		70	°C
storage temperature		-40		85	°C
storage humidity		0		95	%

## SOLDERABILITY

parameter	conditions/description	min	typ	max	units
wave soldering	5~10 seconds ( $\pm 5$ °C)			260	°C
manual welding	3~5 seconds ( $\pm 10$ °C)			360	°C

## MECHANICAL

parameter	conditions/description	min	typ	max	units
dimensions	87.00 x 52.00 x 29.50 (board mount)				mm
	135.00 x 70.00 x 37.90 (chassis mount)				mm
	137.00 x 70.00 x 42.40 (DIN-rail)				mm
weight	board mount		210		g
	chassis mount		290		g
	DIN-rail		360		g
cooling	free air convection				
case material	black plastic, flame-retardant and heat-resistant (UL94V-0)				

## MECHANICAL DRAWING (BOARD MOUNT)

units: mm [inch]

pin diameter tolerance:  $\pm 0.1$  [ $\pm 0.004$ ]

PIN CONNECTIONS	
PIN	Function
1	AC(L)
2	AC(N)
3	+Vo
4	-Vo

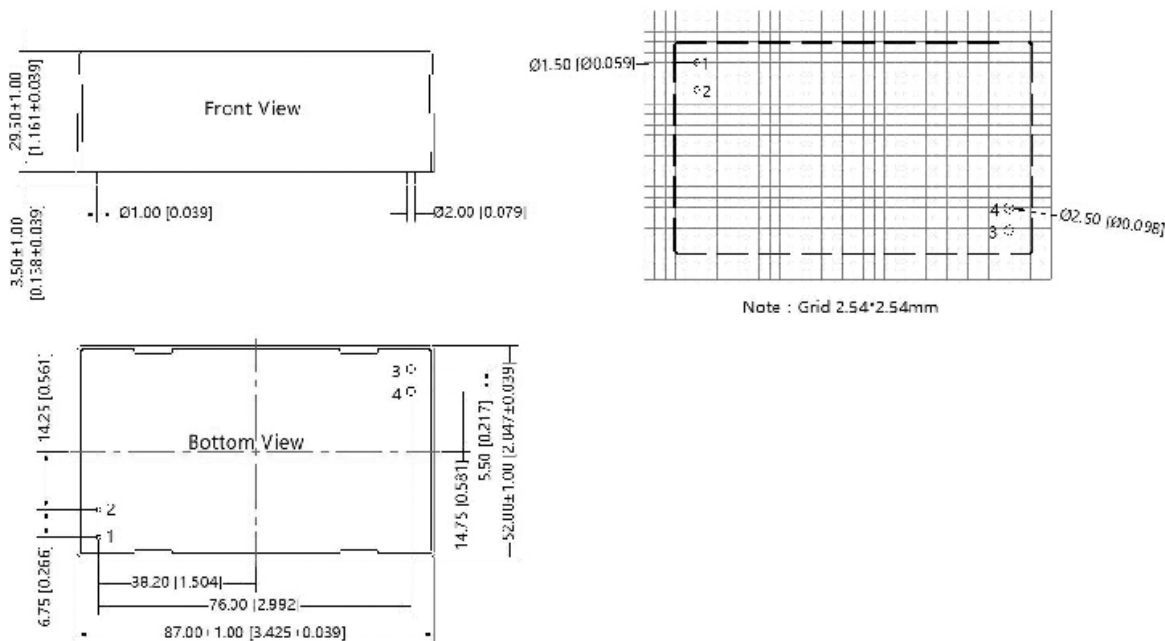

## MECHANICAL DRAWING (CHASSIS MOUNT)

units: mm [inch]  
 tolerance:  $\pm 1.00$  [ $\pm 0.040$ ]  
 wire range: 24 - 12 AWG  
 tightening torque: 0.4 N·m

PIN CONNECTIONS	
PIN	Function
1	AC(L)
2	NC
3	AC(N)
4	+Vo
5	-Vo
6	NC
7	NC
8	NC

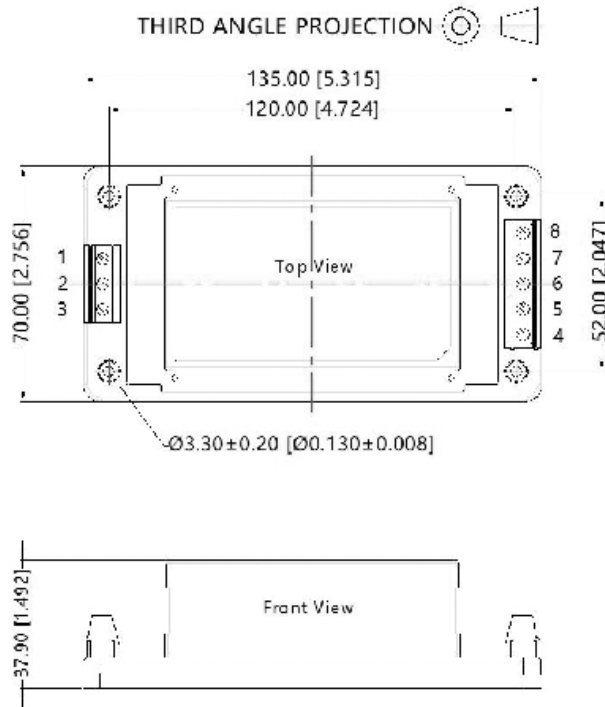

## MECHANICAL DRAWING (DIN-RAIL MOUNT)

units: mm [inch]  
 tolerance:  $\pm 1.00$  [ $\pm 0.040$ ]  
 wire range: 24 - 12 AWG  
 tightening torque: 0.4 N·m  
 installed on DIN-RAIL TS35

PIN CONNECTIONS	
PIN	Function
1	AC(L)
2	NC
3	AC(N)
4	+Vo
5	-Vo
6	NC
7	NC
8	NC

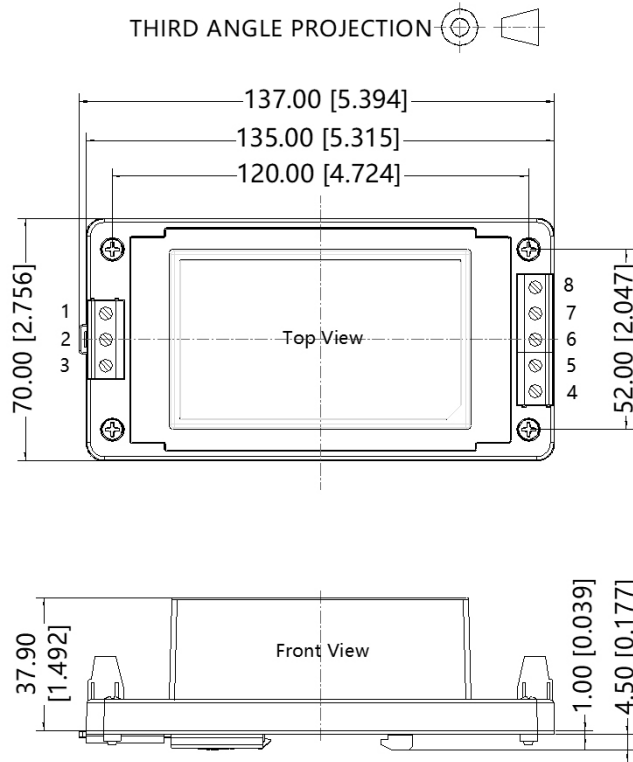

## APPLICATION CIRCUIT

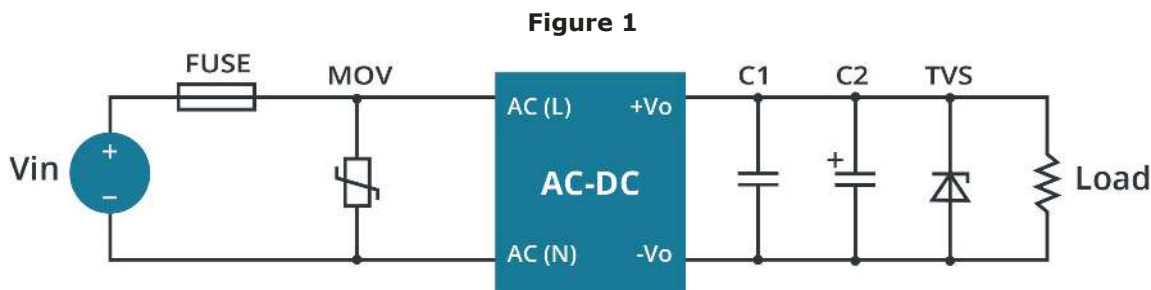

**Table 1**

Recommended External Circuit Components					
Part no.	C1	C2	FUSE	MOV	TVS
PSK-60-5	1 $\mu$ F	680 $\mu$ F	3.15A/250V, slow-blow	S10K300	SMBJ7.0A
PSK-60-12		330 $\mu$ F			SMBJ20A
PSK-60-15		330 $\mu$ F			SMBJ20A
PSK-60-24		200 $\mu$ F			SMBJ30A
PSK-60-48		100 $\mu$ F			SMBJ64A

## EMC RECOMMENDED CIRCUIT

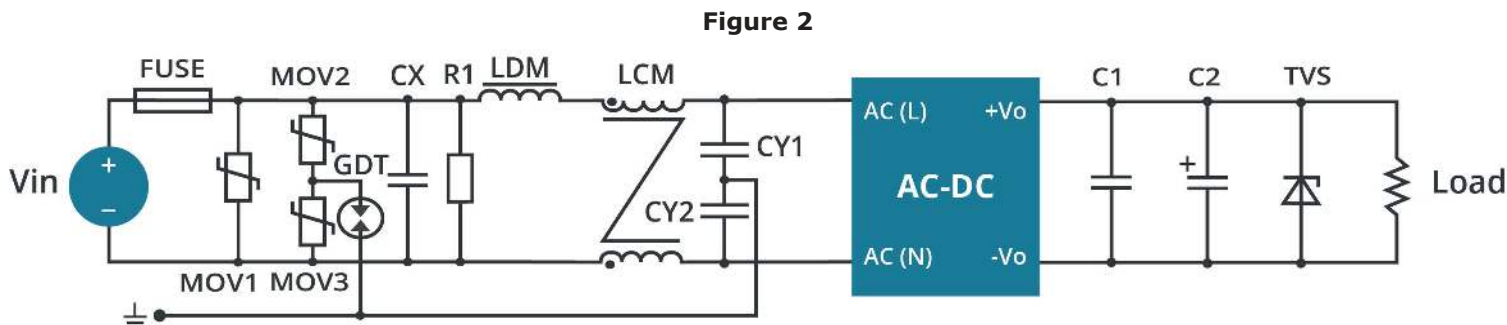

**Table 2**

Component	Reccomended value
FUSE	3.15A/250V, slow-blow, required
MOV1	S20K300
MOV2/MOV3	S10K300
GDT	EM3600XS
CX	0.22 $\mu$ F / 275 Vac
CY1, CY2	1 nF / 400 Vac
R1	1 M $\Omega$ / 2 W
LDM	4.7 $\mu$ H
LCM	2 mH

## REVISION HISTORY

---

rev.	description	date
1.0	initial release	07/14/2020
1.01	din-rail mechanical drawing updated	03/12/2021
1.02	figure and circuit drawings updated	03/25/2021
1.03	UKCA mark added	06/06/2022
1.04	OVP updated	11/02/2022

The revision history provided is for informational purposes only and is believed to be accurate.



**Headquarters**  
20050 SW 112th Ave.  
Tualatin, OR 97062  
**800.275.4899**

Fax 503.612.2383  
**cui.com**  
techsupport@cui.com

CUI offers a two (2) year limited warranty. Complete warranty information is listed on our website.

CUI reserves the right to make changes to the product at any time without notice. Information provided by CUI is believed to be accurate and reliable. However, no responsibility is assumed by CUI for its use, nor for any infringements of patents or other rights of third parties which may result from its use.

CUI products are not authorized or warranted for use as critical components in equipment that requires an extremely high level of reliability. A critical component is any component of a life support device or system whose failure to perform can be reasonably expected to cause the failure of the life support device or system, or to affect its safety or effectiveness.