

DM74174, DM74175 Hex/Quad D Flip-Flops with Clear

General Description

These positive-edge triggered flip-flops utilize TTL circuitry to implement D-type flip-flop logic. All have a direct clear input, and the quad (175) version features complementary outputs from each flip-flop.

Information at the D inputs meeting the setup and hold time requirements is transferred to the Q outputs on the positive-going edge of the clock pulse. Clock triggering occurs at a particular voltage level and is not directly related to the transition time of the positive-going pulse. When the clock input is at either the high or low level, the D input signal has no effect at the output.

- 175 contains four flip-flops with double-rail outputs
- Buffered clock and direct clear inputs
- Individual data input to each flip-flop
- Applications include:
 - Buffer/storage registers
 - Shift registers
 - Pattern generators
- Typical clock frequency 40 MHz
- Typical power dissipation per flip-flop 38 mW
- Alternate Military/Aerospace device (54174, 54175) is available. Contact a Fairchild Semiconductor Sales Office/Distributor for specifications.

Features

- 174 contains six flip-flops with single-rail outputs

Connection Diagrams

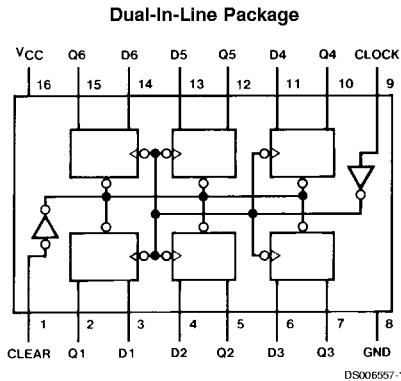

Order Number 54174DMQB, 54174FMQB, DM54174J,
DM54174W or DM74174N
See Package Number J16A, N16E or W16A

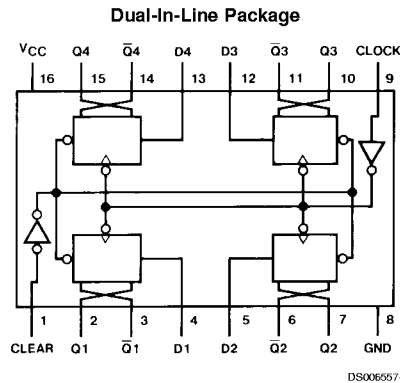

Order Number 54175DMQB, 54175FMQB, DM54175J,
DM54175W or DM74175N
See Package Number J16A, N16E or W16A

Connection Diagrams (Continued)

Function Table

(Each Flip-Flop)

Inputs			Outputs	
Clear	Clock	D	Q	\bar{Q} (Note 1)
L	X	X	L	H
H	↑	H	H	L
H	↑	L	L	H
H	L	X	Q_0	\bar{Q}_0

H = High Level (steady state)

L = Low Level (steady state)

X = Don't Care

↑ = Transition from low to high level

Q_0 = The level of Q before the indicated steady-state input conditions were established.

Note 1: 175 only

Absolute Maximum Ratings (Note 2)

Supply Voltage	7V	DM54 and 54	-55°C to +125°C
Input Voltage	5.5V	DM74	0°C to +70°C
Operating Free Air Temperature Range		Storage Temperature Range	-65°C to +150°C

Recommended Operating Conditions

Symbol	Parameter	DM54174			DM74174			Units
		Min	Nom	Max	Min	Nom	Max	
V _{CC}	Supply Voltage	4.5	5	5.5	4.75	5	5.25	V
V _{IH}	High Level Input Voltage	2			2			V
V _{IL}	Low Level Input Voltage			0.8			0.8	V
I _{OH}	High Level Output Current			-0.8			-0.8	mA
I _{OL}	Low Level Output Current			16			16	mA
f _{CLK}	Clock Frequency (Note 6)	0		30	0		30	MHz
t _w	Pulse Width (Note 6)	Clock Low	25		25			ns
		Clock High	10		10			
		Clear	20		20			
t _{SU}	Data Setup Time (Note 6)	20			20			ns
t _H	Data Hold Time (Note 6)	0			0			ns
t _{REL}	Clear Release Time (Note 6)	30			30			ns
T _A	Free Air Operating Temperature	-55		125	0		70	°C

Note 2: The "Absolute Maximum Ratings" are those values beyond which the safety of the device cannot be guaranteed. The device should not be operated at these limits. The parametric values defined in the "Electrical Characteristics" table are not guaranteed at the absolute maximum ratings. The "Recommended Operating Conditions" table will define the conditions for actual device operation.

'174 Electrical Characteristics

over recommended operating free air temperature range (unless otherwise noted)

Symbol	Parameter	Conditions	Min	Typ (Note 3)	Max	Units
V _I	Input Clamp Voltage	V _{CC} = Min, I _I = -12 mA			-1.5	V
V _{OH}	High Level Output Voltage	V _{CC} = Min, I _{OH} = Max V _{IL} = Max, V _{IH} = Min	2.4			V
V _{OL}	Low Level Output Voltage	V _{CC} = Min, I _{OL} = Max V _{IH} = Min, V _{IL} = Max			0.4	V
I _I	Input Current @ Max Input Voltage	V _{CC} = Max, V _I = 5.5V			1	mA
I _{IH}	High Level Input Current	V _{CC} = Max, V _I = 2.4V			40	μA
I _{IL}	Low Level Input Current	V _{CC} = Max, V _I = 0.4V			-1.6	mA
I _{OS}	Short Circuit Output Current	V _{CC} = Max (Note 4)	DM54	-20	-57	mA
			DM74	-18	-57	
I _{CC}	Supply Current	V _{CC} = Max (Note 5)		45	65	mA

Note 3: All typicals are at V_{CC} = 5V, T_A = 25°C.

Note 4: Not more than one output should be shorted at a time.

Note 5: With all outputs open and all DATA and CLEAR inputs at 4.5V, I_{CC} is measured after a momentary ground, then 4.5V applied to the CLOCK input.

Note 6: T_A = 25°C and V_{CC} = 5V.

'174 Switching Characteristics

at $V_{CC} = 5V$ and $T_A = 25^\circ C$

Symbol	Parameter	From (Input) To (Output)	$R_L = 400\Omega, C_L = 15\text{ pF}$		Units
			Min	Max	
f_{MAX}	Maximum Clock Frequency		30		MHz
t_{PLH}	Propagation Delay Time Low to High Level Output	Clock to Any Q		25	ns
t_{PHL}	Propagation Delay Time High to Low Level Output	Clock to Any Q		25	ns
t_{PHL}	Propagation Delay Time High to Low Level Output	Clear to Any Q		40	ns

Recommended Operating Conditions

Symbol	Parameter	DM54175			DM74175			Units
		Min	Nom	Max	Min	Nom	Max	
V_{CC}	Supply Voltage	4.5	5	5.5	4.75	5	5.25	V
V_{IH}	High Level Input Voltage	2			2			V
V_{IL}	Low Level Input Voltage			0.8			0.8	V
I_{OH}	High Level Output Current			-0.8			-0.8	mA
I_{OL}	Low Level Output Current			16			16	mA
f_{CLK}	Clock Frequency (Note 7)	0		30	0		30	MHz
t_w	Pulse Width (Note 7)	Clock Low	25		25			ns
		Clock High	10		10			
		Clear	20		20			
t_{SU}	Data Setup Time (Note 7)	20			20			ns
t_H	Data Hold Time (Note 7)	0			0			ns
t_{REL}	Clear Release Time (Note 7)	30			30			ns
T_A	Free Air Operating Temperature	-55		125	0		70	$^\circ C$

Note 7: $T_A = 25^\circ C$ and $V_{CC} = 5V$.

'175 Electrical Characteristics

over recommended operating free air temperature range (unless otherwise noted)

Symbol	Parameter	Conditions	Min	Typ (Note 8)	Max	Units
V_I	Input Clamp Voltage	$V_{CC} = \text{Min}, I_I = -12\text{ mA}$			-1.5	V
V_{OH}	High Level Output Voltage	$V_{CC} = \text{Min}, I_{OH} = \text{Max}$ $V_{IL} = \text{Max}, V_{IH} = \text{Min}$	2.4			V
V_{OL}	Low Level Output Voltage	$V_{CC} = \text{Min}, I_{OL} = \text{Max}$ $V_{IH} = \text{Min}, V_{IL} = \text{Max}$			0.4	V
I_I	Input Current @ Max Input Voltage	$V_{CC} = \text{Max}, V_I = 5.5V$			1	mA
I_{IH}	High Level Input Current	$V_{CC} = \text{Max}, V_I = 2.4V$			40	μA
I_{IL}	Low Level Input Current	$V_{CC} = \text{Max}, V_I = 0.4V$			-1.6	mA
I_{OS}	Short Circuit Output Current	$V_{CC} = \text{Max}$ (Note 9)	DM54	-20	-57	mA
			DM74	-18	-57	
I_{CC}	Supply Current	$V_{CC} = \text{Max}$ (Note 10)		30	45	mA

'175 Switching Characteristics

at $V_{CC} = 5V$ and $T_A = 25^\circ C$

Symbol	Parameter	From (Input) To (Output)	$R_L = 400\Omega, C_L = 15\text{ pF}$		Units
			Min	Max	
f_{MAX}	Maximum Clock Frequency		30		MHz
t_{PLH}	Propagation Delay Time Low to High Level Output	Clock to Any Q or \bar{Q}		25	ns
t_{PHL}	Propagation Delay Time High to Low Level Output	Clock to Any Q or \bar{Q}		25	ns
t_{PLH}	Propagation Delay Time Low to High Level Output	Clear to Any \bar{Q}		25	ns
t_{PHL}	Propagation Delay Time High to Low Level Output	Clear to Any Q		40	ns

Note 8: All typicals are at $V_{CC} = 5V, T_A = 25^\circ C$.

Note 9: Not more than one output should be shorted at a time.

Note 10: With all outputs open and 4.5V applied to all DATA and CLEAR inputs, I_{CC} is measured after a momentary ground then 4.5V applied to the CLOCK.

Logic Diagrams

174

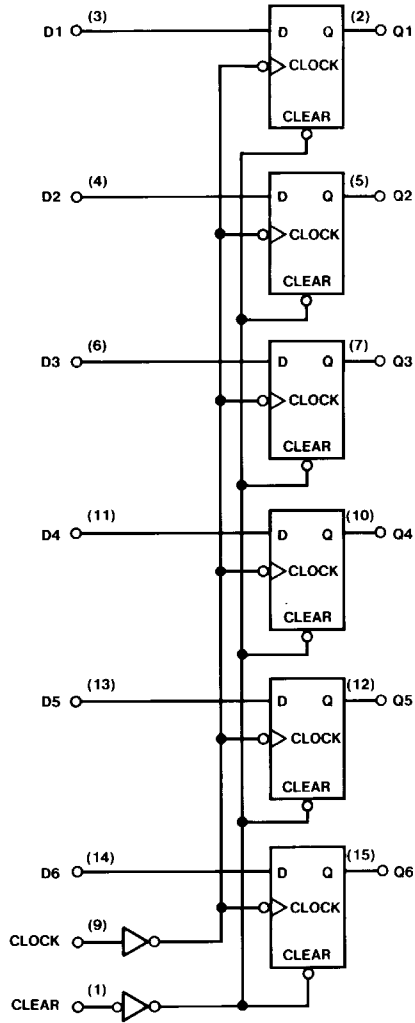

DS006557-3

175

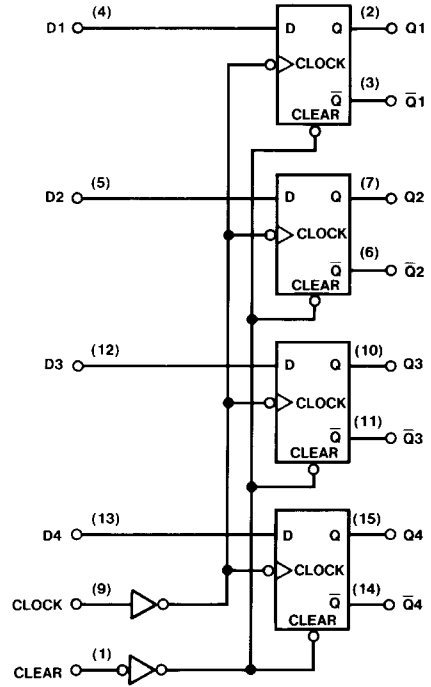

DS006557-4

Physical Dimensions inches (millimeters) unless otherwise noted

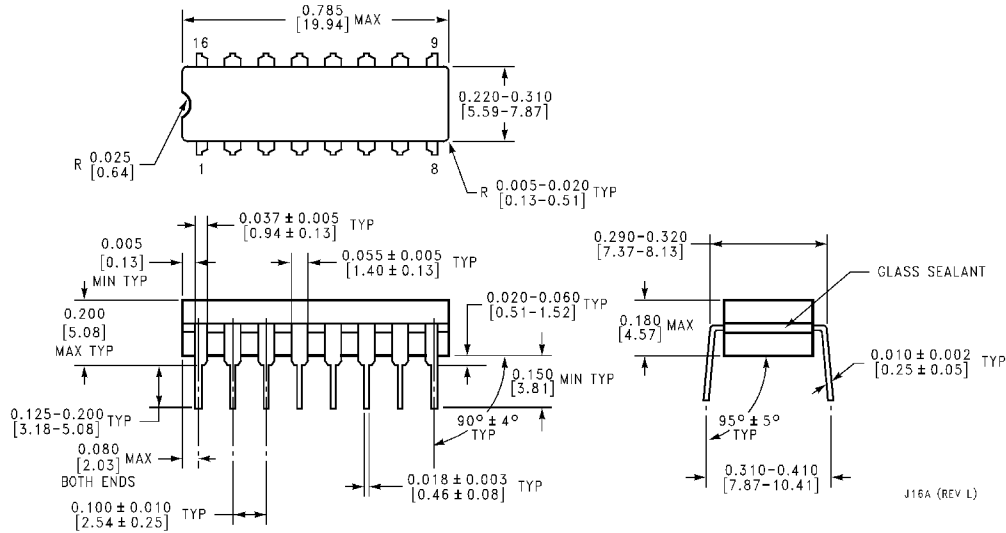

16-Lead Ceramic Dual-In-Line Package (J)
Order Number 54174DMQB, 54175DMQB, DM54174J or DM54175J
Package Number J16A

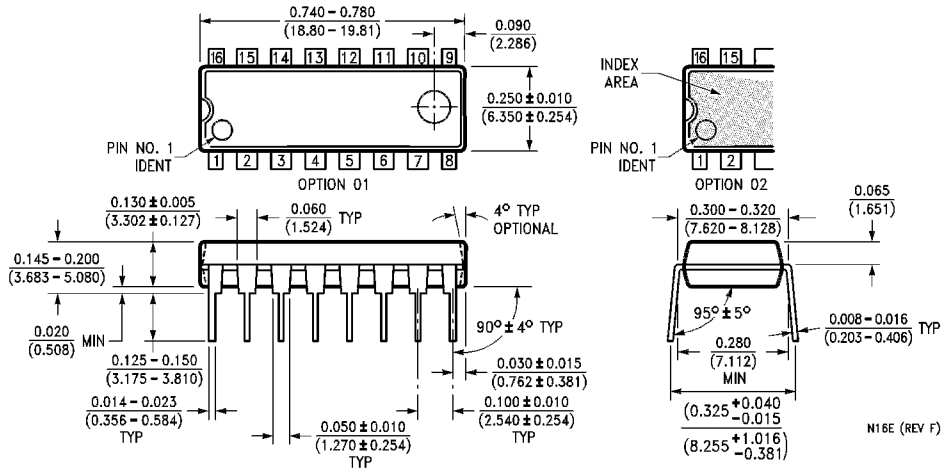

16-Lead Molded Dual-In-Line Package (N)
Order Number DM74174N or DM74175N
Package Number N16E

Physical Dimensions inches (millimeters) unless otherwise noted (Continued)

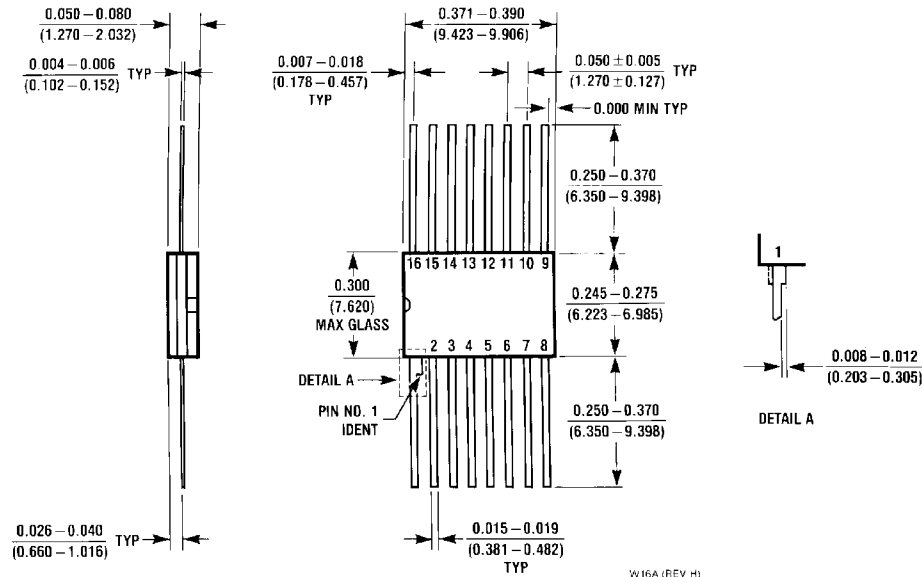

16-Lead Ceramic Flat Package (W)
Order Number 54174FMQB, 54175FMQB, DM54174W or DM54175W
Package Number W16A

LIFE SUPPORT POLICY

FAIRCHILD'S PRODUCTS ARE NOT AUTHORIZED FOR USE AS CRITICAL COMPONENTS IN LIFE SUPPORT DEVICES OR SYSTEMS WITHOUT THE EXPRESS WRITTEN APPROVAL OF THE PRESIDENT OF FAIRCHILD SEMICONDUCTOR CORPORATION. As used herein:

1. Life support devices or systems are devices or systems which, (a) are intended for surgical implant into the body, or (b) support or sustain life, and (c) whose failure to perform when properly used in accordance with instructions for use provided in the labeling, can be reasonably expected to result in a significant injury to the user.
2. A critical component in any component of a life support device or system whose failure to perform can be reasonably expected to cause the failure of the life support device or system, or to affect its safety or effectiveness.

Fairchild Semiconductor Corporation Americas
 Customer Response Center
 Tel: 1-888-522-5372

Fairchild Semiconductor Europe
 Fax: +49 (0) 1 80-530 85 86
 Email: europe.support@nsc.com
 Deutsch Tel: +49 (0) 8 141-35-0
 English Tel: +44 (0) 1 793-85-68-56
 Italy Tel: +39 (0) 2 57 5631

Fairchild Semiconductor Hong Kong Ltd.
 13th Floor, Straight Block,
 Ocean Centre, 5 Canton Rd.
 Tsimshatsui, Kowloon
 Hong Kong
 Tel: +852 2737-7200
 Fax: +852 2314-0061

National Semiconductor Japan Ltd.
 Tel: 81-3-5620-6175
 Fax: 81-3-5620-6179

www.fairchildsemi.com