

# XLR Connectors

## AX Series XLR Cable Connectors



# AX SERIES XLR CABLE CONNECTORS

The revolutionary AX series of XLR connectors introduce an exciting contemporary look and feel to the professional audio interconnect market. They are designed to complement modern audio architecture and truly "fit" within their environment. An impressive list of features guarantees pure sound performance in the most demanding applications providing unrivalled value.

### Features

- Unique Australian designed shell and housing.
- One piece ground / latch spring design incorporating twin wipe contacts for a direct connection path from mating shell to ground providing enhanced connection and EMI performance.
- Ergonomic sleeve design for improved grip.
- Channel I.D capability with coloured sleeves.
- Oversized ergonomic latch for quick and easy mating.
- Leading first mate last break pin 1 on socket connectors.
- Chuck style cable clamp to suit 3mm - 8mm (0.118" - 0.314") cable O.D. with integrated split to allow inclusion after soldering.
- Concealed latching point for improved aesthetics, sealing and strength.
- Overmolded boot with flex bend relief for improved aesthetics, cable protection and boot retention.
- Concentric socket contact design provides optimal contact resistance
- Precision machined pin contacts as standard.
- Compact solder buckets to reduce termination time and material wastage during the soldering process.
- Zinc diecast shell housing for robustness and wear with Satin nickel or Black finish.
- Available in 3,4 and 5 contact arrangements.

### Options

- Coloured I.D sleeves.
- Satin nickel or Black shell finish.
- Single or Bulk packaging.
- Gold plated contacts.

### Ordering Codes

We have listed the more common ordering codes in each section. For further options please refer to the part number breakdown charts. Please contact us if you need any further assistance.

### Simple steps to guide you in using this catalogue

- 1) Identify the product group listed in Contents on page 1 and go directly to that page number.
- 2) Each product group cover page then details information and options available.
- 3) Refer to the product detail pages and identify the product you require pictorially.
- 4) Read the product description column for the products standard features.
- 5) Use variations column to determine your choice.
- 6) Identify part number.
- 7) In the event the particular option you require is not listed please refer to the part number breakdown page at the end of each section.
- 8) Please contact us directly if you have any further problems.

# XLR Connectors

## AX Series XLR Cable Connectors



### Features:

- Unique Australian designed shell and housing.
- Ergonomic stylish sleeve design for improved grip.
- Oversized latch lever preserves your thumb.
- Leading first mate last break pin 1 on socket connectors.
- Chuck style cable clamp to suit 3mm - 8mm (0.118" - 0.314") cable O.D. with integrated split to allow inclusion after soldering.
- Overmolded cable support boot.
- New socket contact design for improved contact resistance.
- Precision machined pin contacts as standard.
- Compact solder buckets to reduce soldering time and wastage.
- Zinc diecast shell housing with Satin nickel or Matt black finish.
- Available in 3,4 and 5 contact arrangements.

### Options:

- Coloured I.D sleeves.
- Satin nickel or Matt black shell finish.
- Single or Bulk packaging.

**Part Number Breakdown: Page 5**

**Specifications: Page 8**











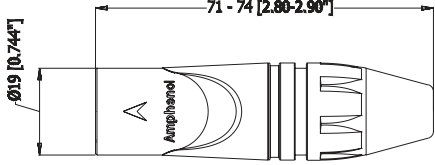

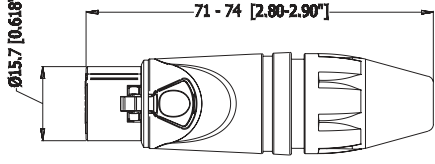
**Assembly Instructions: Page 6 & 7**

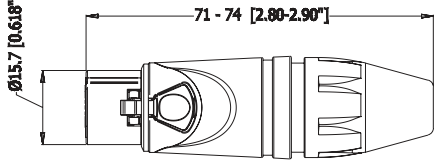
PRODUCT - FIGURE	DRAWING	DESCRIPTION	VARIATIONS	PART NUMBER
		XLR 3 pole male Machined contacts Nickel Finish	Standard	AX3M
			Bulk Pack	AX3M BULK
		XLR 3 pole male Machined contacts Black Finish	Standard	AX3MB
			Gold Plated Contacts	AX3MB-AU
			Bulk Pack	AX3MB BULK
		XLR 3 pole female Stamped contacts Nickel Finish	Standard	AX3F
			Bulk Pack	AX3F BULK
		XLR 3 pole female Stamped contacts Black Finish	Standard	AX3FB
			Gold Plated Contacts	AX3FB-AU
			Bulk Pack	AX3FB BULK
		XLR 4 pole male Machined contacts Nickel Finish	Standard	AX4M
			Bulk Pack	AX4M BULK

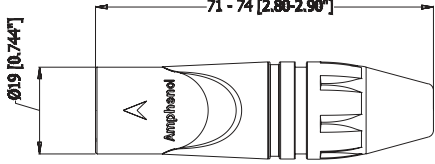
\*PI538 is available for download at [www.amphenolaudio.com](http://www.amphenolaudio.com)

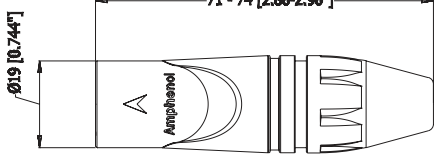
# XLR Connectors

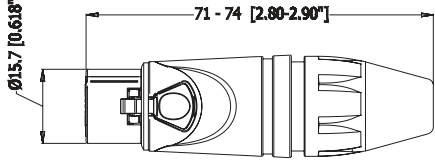
## AX Series XLR Cable Connectors

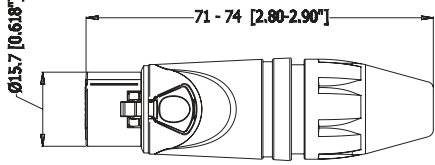
PRODUCT - FIGURE	DRAWING Dimensions in mm (inches)	DESCRIPTION	VARIATIONS	PART NUMBER
		XLR 4 pole male Machined contacts Black Finish	Standard	AX4MB
			Gold Plated Contacts	AX4MB-AU
			Bulk Pack	AX4MB BULK
		XLR 4 pole female Machined contacts Nickel Finish	Standard	AX4F
			Bulk Pack	AX4F BULK
		XLR 4 pole female Machined contacts Black Finish	Standard	AX4FB
			Gold Plated Contacts	AX4FB-AU
			Bulk Pack	AX4FB BULK
		XLR 5 pole male Machined contacts Nickel Finish	Standard	AX5M
			Bulk Pack	AX5M BULK
		XLR 5 pole male Machined contacts Black Finish	Standard	AX5MB
			Gold Plated Contacts	AX5MB-AU
			Bulk Pack	AX5MB BULK
		XLR 5 pole female Machined contacts Nickel Finish	Standard	AX5F
			Bulk Pack	AX5F BULK
		XLR 5 pole female Machined contacts Black Finish	Standard	AX5FB
			Gold Plated Contacts	AX5FB-AU
			Bulk Pack	AX5FB BULK

# PART NUMBER BREAKDOWN

## METAL SHELL TYPE - SOLDER

E. G . **AX3MB2M-AU BULK**  
**AX** (Series Prefix), **3** contacts, **Male**, **Black** Finish,  
**2** (Red Sleeve) **M** (Sleeve Marking) - **AU** (Gold Plated Contacts), **Bulk** Packaged.

<b>SERIES PREFIX</b>	AX = Series Prefix
<b>CONTACT LAYOUTS</b>	3 = 3 Contacts 4 = 4 Contacts 5 = 5 Contacts
<b>GENDER</b>	F = Female Socket Contacts M = Male Pin Contacts
<b>SHELL FINISH</b>	Blank = Nickel Plated Finish B = Black Finish
<b>SLEEVE COLOUR OPTION</b>	Blank = Black 1 = Brown 2 = Red 3 = Orange 4 = Yellow 5 = Green 6 = Blue 7 = Violet 8 = Grey 9 = White
<b>SLEEVE MARKING</b>	Blank = Standard Sleeve OM = Marking Sleeve (Black) M = Marking Sleeve (Colour)
<b>CONTACT PLATING</b>	Blank = Standard Plating (Silver or Tin) (Refer to Standard Data) AU = Gold Plated
<b>PACKAGING</b>	Blank = Individual Bags BULK = Bulk Packed

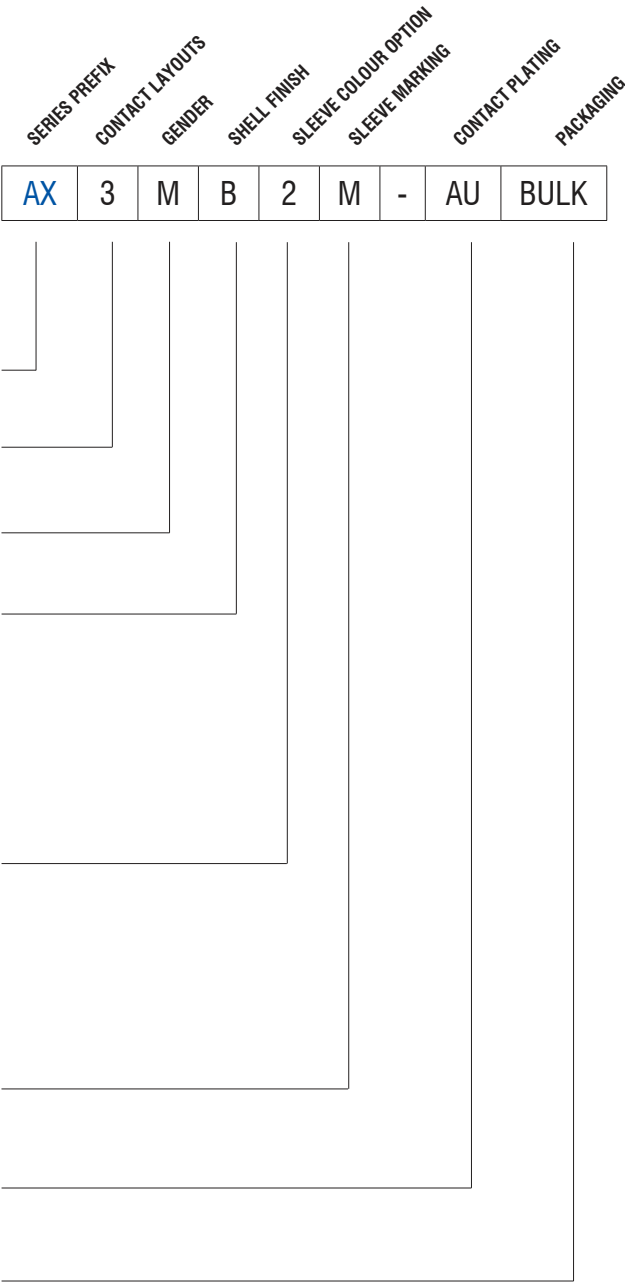

# XLR Connectors

## AX Series XLR Cable Connectors

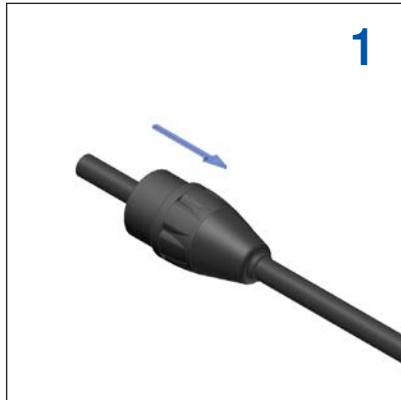

Slide the nut (Backshell) onto the cable

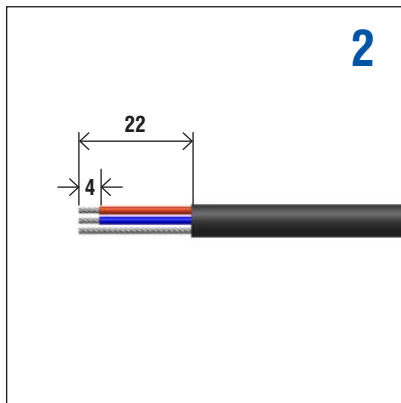

Strip the cable

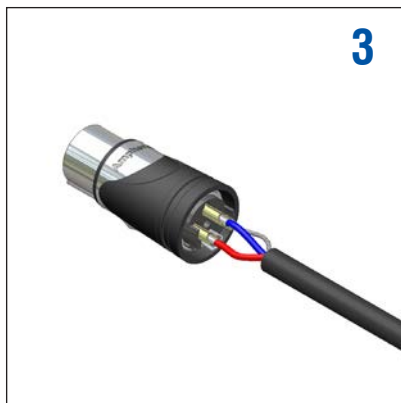

Push back the insert only enough to expose the solder buckets. It is not necessary to remove the insert. Solder the wires to the contacts.



Install the cable clamp, flush to the insert making sure to align the top slot with the spring. Then push the insert & cable clamp together into the shell.



Thread the nut (Backshell) onto the shell (Torque 0.8Nm - 1.2Nm) to activate the cable clamp and close the connector assembly.

# PI539 ASSEMBLY INSTRUCTIONS

## AX SERIES FEMALE XLR CABLE CONNECTOR

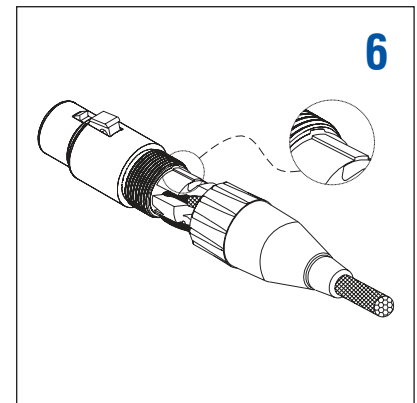

Close the cable clamp slightly and push the boot over the clamp ensuring the wires fit inside the boot.

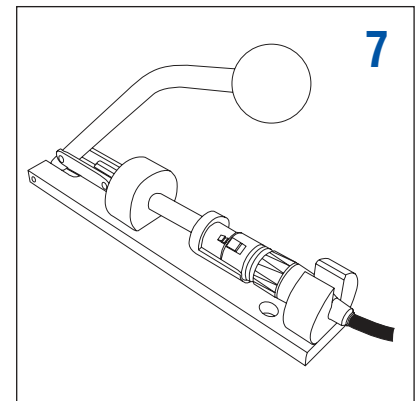

Final assembly can be achieved either by manually screwing the boot on, or by using an Amphenol Australia T2860 termination tool.

# PI538 ASSEMBLY INSTRUCTIONS

AX SERIES MALE XLR  
CABLE CONNECTOR

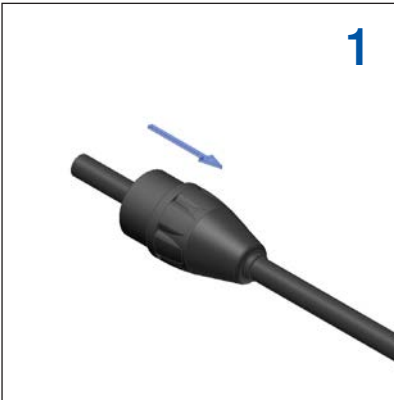

1

Slide the nut (Backshell) onto the cable

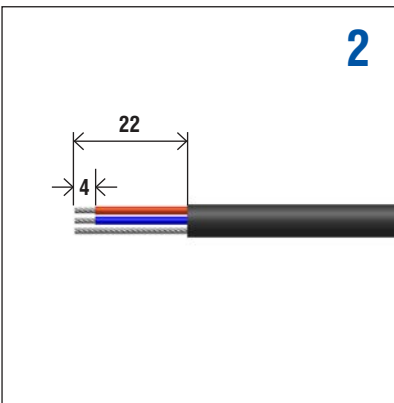

2

Strip the cable

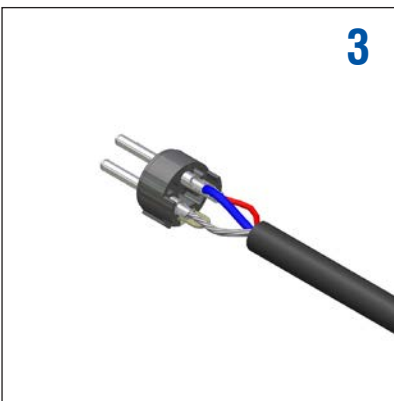

3

Solder the wires to the contacts.



4

Install the cable clamp flush to the insert making sure to align the slot with the ground contact.



5

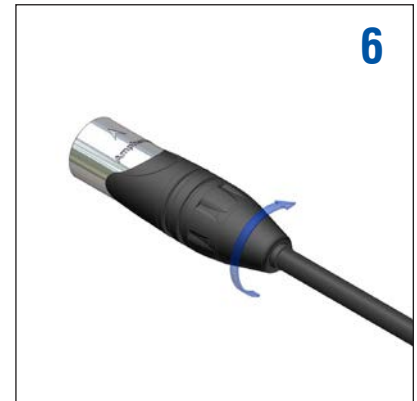

Align the key of the insert with the keyway on the shell then push the pin insert & cable clamp together in the shell.



6

Thread the nut (Backshell) onto the shell (Torque 0.8Nm - 1.2Nm) to activate the cable clamp and close the connector assembly.

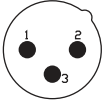
# STANDARD DATA AX SERIES CABLE CONNECTORS

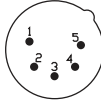
		VALUE		
<b>GENERAL CHARACTERISTICS</b>	Number of contacts	3	4	5
	AX Series Contact Arrangements (Front view of pin inserts)			
	Termination	SOLDER		
	Max. Wire Gauge - Stranded wire: Solder	14AWG	16AWG	18AWG
	Flammability rating of insulator plastics and housings	UL94V-0		
	Environmental	Complies with EU RoHS 2 Directive 2011/65/EU		
<b>ELECTRICAL CHARACTERISTICS</b>	Service Voltage RMS	133V <sup>1)</sup>		
	Test Voltage AC RMS	1400V		
	Current carrying capacity: Solder	15A	10A	7.5A
	Typical Contact Resistance	≤3m Ω		
	Insulation Resistance	≥1G Ω		
<b>CLIMATIC CHARACTERISTICS</b>	Protection Class	IP40		
	Operating Temperature	-25°C to +75°C (-13°F to +167°F)		
<b>MECHANICAL CHARACTERISTICS</b>	Insertion and Withdrawal force	≥10N - ≤30N		
	Weight <sup>2)</sup>	31g (0.068lb)	33g (0.073lb)	33g (0.073lb)
	Typical Cable retention force	22Kg to 44Kg (50lb to 100lb) - Dependent on cable material and diameter.		
	Cable O.D. range	3mm to 8mm (0.118" to 0.314")		
	Mechanical Operations	1000 mating cycles		
<b>MATERIALS</b>	Connector shell - Metal Shell finish	Diecast Zinc Alloy Satin nickel or Black		
	Insulators	UL94V-0 PA66, 30% Glass Filled		
	Boot / Backshell Finish	UL94V-0 Noryl N190 / Santoprene Black, other colours available - see page 80		
	Cable clamp	Noryl N190		
	Sleeve	Noryl N190		
	Male Contact Machined - Solder / Plating	Brass / Silver or Gold (Optional)		
	Female Contact Stamped - Solder / Plating	Phosphor Bronze / Tin or Gold (Optional)		

Rev 3 - 03/2013

<sup>1)</sup> Not suitable for domestic applications above 50V

<sup>2)</sup> Approximate weight only, does not include packaging. Please contact us for exact weight for shipping purposes.

# AC SERIES XLR CABLE CONNECTORS



Amphenol Australia have been manufacturing and designing innovative XLR connectors since 1955. The AC series cable connector range complies with IEC268-12 and AES 14-1992 standards. CSA File Number 68598.

### Features

- AC series XLR connectors feature the unique Australian design and patented “Jaws” cable retention system
- A leading first mate last break socket contact is standard on all female connectors (Pin 1).
- The “Jaws” cable retention system provides up to 44kg (100lb) of strain.
- The AC series connector can be quickly and easily assembled without screws – by hand or portable termination tool. (Part number T2860)
- Available in 3, 4, 5, 6A and 7 contact arrangements.
- Compatible with all major XLR brands.

### Options

- Solder Bucket termination
- Thermoplastic shell
- Zinc Diecast shell - Satin Nickel Finish
- Zinc Diecast shell - Black Polyester Finish
- Gold, Silver or Tin Plated contacts
- Bulk Style Packaging
- Single Bag packs
- Precision machined contacts
- Cost effective stamped contacts on 3 pole
- Standard Jaws cable clamp, Cable O.D 3mm to 6.5mm (0.118” to 0.255”)
- Large Jaws cable clamp, Cable O.D 6.5mm to 8mm (0.255” to 0.314”)
- Metal Boots / Backshells
- Coloured Boots / Backshells
- Coloured Identification rings
- Termination / Assembly tooling

### Jaws Cable Clamp Options



Standard Jaws cable clamp (Black), Cable O.D 3mm to 6.5mm (0.118” to 0.255”)



Large Jaws cable clamp (Purple), Cable O.D 6.5mm to 8mm (0.255” to 0.314”)

### Ordering Codes

We have listed the more common ordering codes in each section. For further options please refer to the part number breakdown charts. Please contact us if you need any further assistance.

### Simple steps to guide you in using this catalogue

- 1) Identify the product group listed in Contents on page 1 and go directly to that page number.
- 2) Each product group cover page then details information and options available.
- 3) Refer to the product detail pages and identify the product you require pictorially.
- 4) Read the product description column for the products standard features.
- 5) Use variations column to determine your choice.
- 6) Identify part number.
- 7) In the event the particular option you require is not listed please refer to the part number breakdown page at the end of each section.
- 8) Please contact us directly if you have any further problems.



# XLR Connectors

## AC Series XLR Cable Connectors



### Features:

- Zinc Diecast Shell.
- Solder Bucket connections.
- “Jaws” Cable Retention System.
- Contact layouts in 3, 4, 5, 6A and 7.
- Precision machined or Stamped contacts.
- Leading first mate last break socket contact.
- Quick and easy assembly without screws – by hand or portable termination tool. (Part number T2860.)

**Options:** Stamped Contacts (3 contact only), Gold plated contacts, Large or Small Jaws Cable Clamp, Black Finish Shell, Bulk Pack, Coloured Boots / Backshells











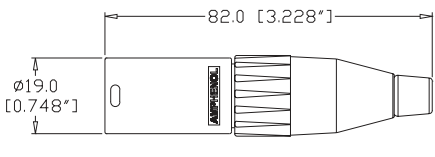

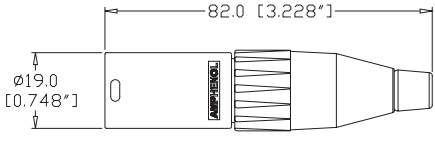

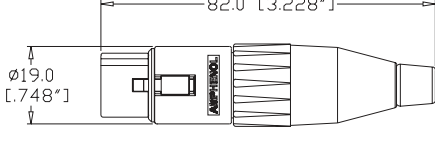

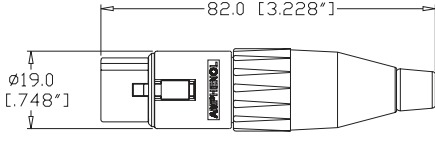

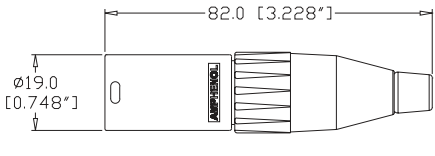
**Part Number Breakdown: Page 13**

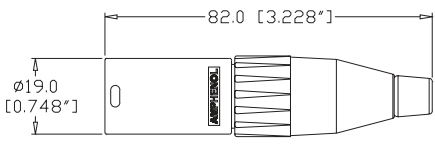
**Specifications: Page 15**

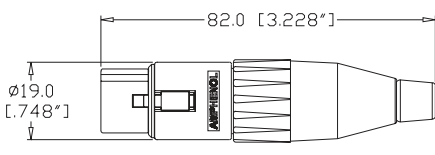
PRODUCT - FIGURE	DRAWING	DESCRIPTION	VARIATIONS	PART NUMBER
		XLR 3 pole male, Machined contacts, Nickel Finish, Jaws cable clamp	Standard	AC3MM
			Bulk Pack	AC3MM BULK
		XLR 3 pole male, Machined contacts, Black Finish, Jaws cable clamp	Standard	AC3MMB
			Gold Plated Contacts	AC3MMB-AU
			Bulk Pack	AC3MMB BULK
		XLR 3 pole male, Stamped contacts, Nickel Finish, Jaws cable clamp	Standard	AC3M
			Large Cable Clamp	AC3MJ
			Bulk Pack	AC3M BULK
		XLR 3 pole male, Stamped contacts, Black Finish, Jaws cable clamp	Standard	AC3MB
			Gold Plated Contacts	AC3MB-AU
			Large Cable Clamp	AC3MBJ
			Bulk Pack	AC3MB BULK
		XLR 3 pole female, Stamped contacts, Nickel Finish, Jaws cable clamp	Standard	AC3F
			Large Cable Clamp	AC3FJ
			Bulk Pack	AC3F BULK
		XLR 3 pole female, Stamped contacts, Black Finish, Jaws cable clamp	Standard	AC3FB
			Gold Plated Contacts	AC3FB-AU
			Large Cable Clamp	AC3FBJ
			Bulk Pack	AC3FB BULK

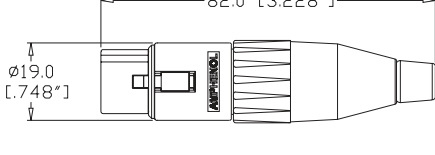









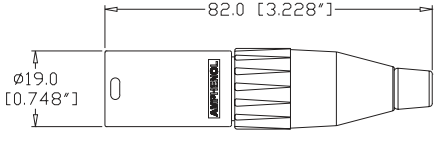

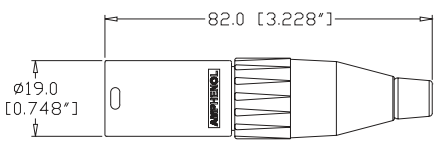

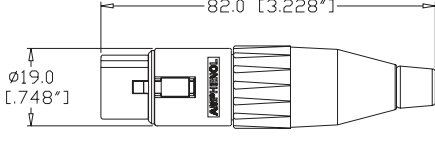
# XLR Connectors

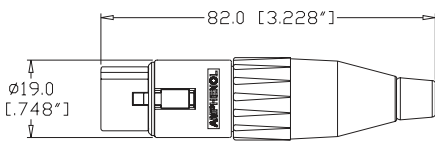
## AC Series XLR Cable Connectors

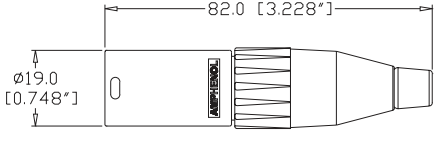
PRODUCT - FIGURE	DRAWING Dimensions in mm (inches)	DESCRIPTION	VARIATIONS	PART NUMBER
		XLR 4 pole male, Machined contacts, Nickel Finish, Jaws cable clamp	Standard	AC4M
			Large Cable Clamp	AC4MJ
			Bulk Pack	AC4M BULK
		XLR 4 pole male, Machined contacts, Black Finish, Jaws cable clamp	Standard	AC4MB
			Gold Plated Contacts	AC4MB-AU
			Large Cable Clamp	AC4MBJ
		XLR 4 pole female, Machined contacts, Nickel Finish, Jaws cable clamp	Standard	AC4F
			Large Cable Clamp	AC4FJ
			Bulk Pack	AC4F BULK
		XLR 4 pole female, Machined contacts, Black Finish, Jaws cable clamp	Standard	AC4FB
			Gold Plated Contacts	AC4FB-AU
			Large Cable Clamp	AC4FBJ
		XLR 4 pole female, Machined contacts, Nickel Finish, Jaws cable clamp	Standard	AC5M
			Large Cable Clamp	AC5MJ
			Bulk Pack	AC5M BULK
		XLR 5 pole male, Machined contacts, Black Finish, Jaws cable clamp	Standard	AC5MB
			Gold Plated Contacts	AC5MB-AU
			Large Cable Clamp	AC5MBJ
		XLR 5 pole male, Machined contacts, Nickel Finish, Jaws cable clamp	Standard	AC5F
			Large Cable Clamp	AC5FJ
			Bulk Pack	AC5F BULK
		XLR 5 pole female, Machined contacts, Black Finish, Jaws cable clamp	Standard	AC5FB
			Gold Plated Contacts	AC5FB-AU
			Large Cable Clamp	AC5FBJ
		XLR 5 pole female, Machined contacts, Nickel Finish, Jaws cable clamp	Standard	AC5FB
			Gold Plated Contacts	AC5FB-AU
			Large Cable Clamp	AC5FBJ
		XLR 5 pole female, Machined contacts, Black Finish, Jaws cable clamp	Standard	AC5FB
			Gold Plated Contacts	AC5FB-AU
			Large Cable Clamp	AC5FBJ
		XLR 5 pole female, Machined contacts, Nickel Finish, Jaws cable clamp	Standard	AC5FB
			Gold Plated Contacts	AC5FB-AU
			Large Cable Clamp	AC5FBJ

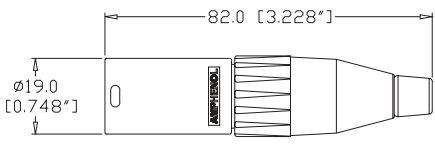
# XLR Connectors

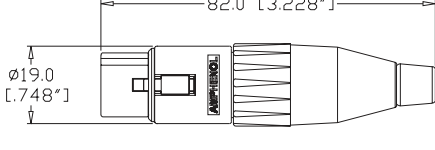
## AC Series XLR Cable Connectors

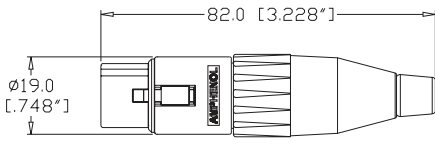
PRODUCT - FIGURE	DRAWING	Dimensions in mm (inches)	DESCRIPTION	VARIATIONS	PART NUMBER
			XLR 6A pole male, Machined contacts, Nickel Finish, Jaws cable clamp	Standard	AC6AM
				Large Cable Clamp	AC6AMJ
				Bulk Pack	AC6AM BULK
			XLR 6A pole male, Machined contacts, Black Finish, Jaws cable clamp	Standard	AC6AMB
				Gold Plated Contacts	AC6AMB-AU
				Large Cable Clamp	AC6AMBJ
Bulk Pack	AC6AMB BULK				
			XLR 6A pole female, Machined contacts, Nickel Finish, Jaws cable clamp	Standard	AC6AF
				Large Cable Clamp	AC6AFJ
				Bulk Pack	AC6AF BULK
			XLR 6A pole female, Machined contacts, Black Finish, Jaws cable clamp	Standard	AC6AFB
				Gold Plated Contacts	AC6AFB-AU
				Large Cable Clamp	AC6AFBJ
Bulk Pack	AC6AFB BULK				
			XLR 7 pole male, Gold plated Machined contacts, Nickel Finish, Jaws cable clamp	Standard	AC7M
				Large Cable Clamp	AC7MJ
				Bulk Pack	AC7M BULK
			XLR 7 pole male, Gold plated Machined contacts, Black Finish, Jaws cable clamp	Standard	AC7MB
				Large Cable Clamp	AC7MBJ
				Bulk Pack	AC7MB BULK
			XLR 7 pole female, Gold plated Machined contacts, Nickel Finish, Jaws cable clamp	Standard	AC7F
				Large Cable Clamp	AC7FJ
				Bulk Pack	AC7F BULK
			XLR 7 pole female, Gold plated Machined contacts, Black Finish, Jaws cable clamp	Standard	AC7FB
				Large Cable Clamp	AC7FBJ
				Bulk Pack	AC7FB BULK

# PART NUMBER BREAKDOWN

## METAL SHELL TYPE - SOLDER

E. G. **AC3MMBJ-AU BULK**  
**AC** (Series Prefix), **3** contacts, **M**ale, **M**achined Contacts, **B**lack Polyester Finish,  
**J** (Large Jaws),- **AU** (Gold Plated Contacts), **BULK** Packaged.

<b>SERIES PREFIX</b>	AC = Series Prefix
<b>CONTACT LAYOUTS</b>	3 = 3 Contacts 4 = 4 Contacts 5 = 5 Contacts 6A = 6 Contacts 7 = 7 Contacts
<b>GENDER</b>	F = Female Socket Contacts M = Male Pin Contacts
<b>CONTACT<sup>1</sup></b>	Blank = Stamped Contacts M = Machined Contacts G = Stamped Contacts, Ground Tag MG = Machined Contacts, Ground Tag (Applicable 3 male pin contacts, option M & MG only)
<b>SHELL FINISH<sup>2</sup></b>	Blank = Nickel Plated Finish B = Black Polyester Finish
<b>CABLE CLAMP</b>	Blank = Standard Jaws 3mm - 6.5mm cable O.D. (0.118" to 0.255") J = Large Jaws 6.5mm - 8mm cable O.D. (0.255" to 0.314")
<b>CONTACT PLATING<sup>3</sup></b>	Blank = Standard Plating (Silver or Tin) (Refer to Standard Data) AU = Gold Plated
<b>PACKAGING</b>	Blank = Individual Bags BULK = Bulk Packed

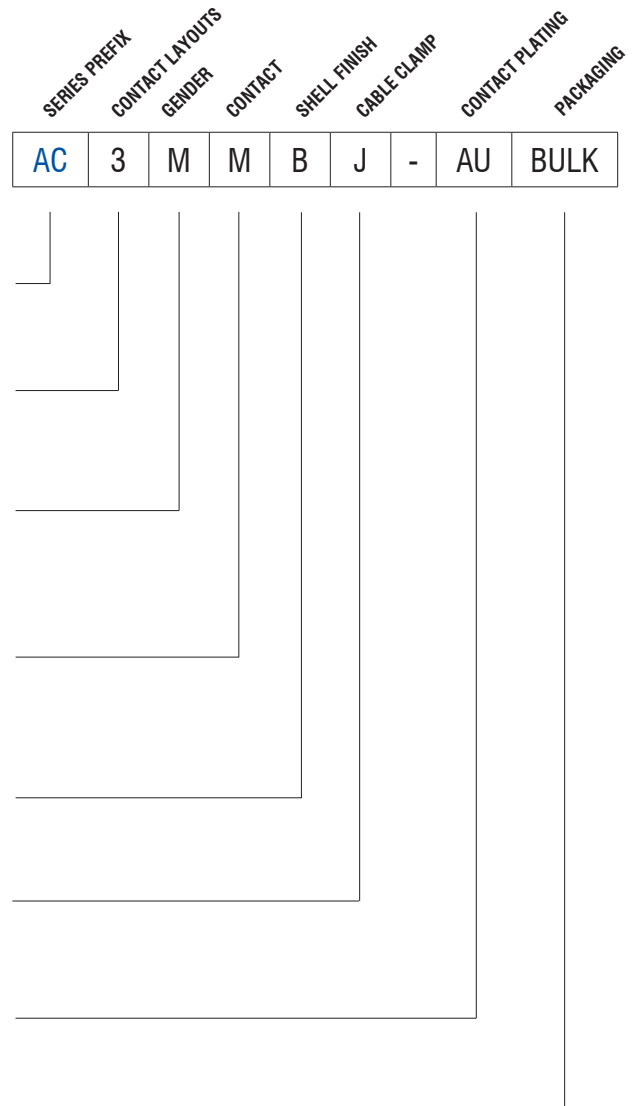

**Note:**

- <sup>1</sup> 4 - 7 contact connectors have machined contacts and grounding as standard.
- <sup>2</sup> Ground contacts are not supplied with the black polyester finish shell option.
- <sup>3</sup> 7 Contact is gold plated as standard.
- <sup>4</sup> All AC Series Connectors are available with optional colour coded boot / backshell. Refer to page 136 and simply add colour to end of part number. Example: AC3MM - RED

# XLR Connectors

## AC Series XLR Cable Connectors



### Features:

- Thermoplastic Shell.
- Solder Bucket Connections.
- "Jaws" Cable Retention System.
- Stamped or Machined Contacts.
- Leading first mate last break socket contact.
- Quick and easy assembly without screws – by hand or portable termination tool. (Part number T2860.)

**Options:** Gold Plated Contacts, Stamped Contacts (3 Contact only), Bulk Pack, Coloured Boots / Backshells 3, 4, 5, 6A and 7 Contacts.

**Specifications:** [Page 15](#)

PRODUCT - FIGURE	DRAWING	DESCRIPTION	VARIATIONS	PART NUMBER
		XLR 3 pole male, Machined contacts, Thermoplastic shell, Jaws cable clamp	Standard	AC3MMCP
			Bulk Pack	AC3MMCP BULK
		XLR 3 pole male, Stamped contacts, Thermoplastic shell, Jaws cable clamp	Standard	AC3MCP
			Bulk Pack	AC3MCP BULK
		XLR 3 pole female, Stamped contacts, Thermoplastic shell, Jaws cable clamp	Standard	AC3FCP
			Bulk Pack	AC3FCP BULK

**Note:** Thermoplastic shell connectors are also available in 4 - 7 contact arrangements, please contact us for ordering code.

# STANDARD DATA AC CABLE CONNECTORS

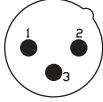
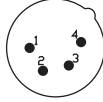
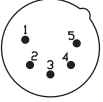
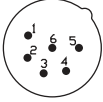
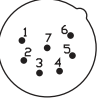
		VALUE				
<b>GENERAL CHARACTERISTICS</b>	Number of contacts	3	4	5	6A	7
	AC Series Contact Arrangements (Front view of pin inserts)					
	Termination	SOLDER				
	Max. Wire Gauge - Stranded wire: Solder	14AWG	16AWG	18AWG		20AWG
	Flammability rating (insulator plastics & housings)	UL94V-0				
	Environmental	Complies with EU RoHS 2 Directive 2011/65/EU				
<b>ELECTRICAL CHARACTERISTICS</b>	Service Voltage RMS	133V <sup>1</sup>				
	Test Voltage AC RMS	1400V				
	Current carrying capacity: Solder	15A	10A	7.5A		5A
	Typical Contact Resistance	≤3mΩ				
	Insulation Resistance	≥1GΩ				
<b>CLIMATIC CHARACTERISTICS</b>	Protection Class	IP40				
	Operating Temperature	-25 °C to +75 °C (-13°F to +167°F)				
<b>MECHANICAL CHARACTERISTICS</b>	Insertion and Withdrawal force	≥ 10N - ≤30N				
	Weight - Metal <sup>2</sup>	36g (0.080lb)	37g (0.081lb)	38g (0.083lb)		
	Weight - Thermoplastic <sup>2</sup>	18g (0.039lb)	19g (0.041lb)	20g (0.044lb)		
	Typical Cable retention force	22Kg to 44Kg (50lb to 100lb) - Dependent on cable material and diameter.				
	Cable O.D. range - JAWS clamp	Standard	3mm to 6.5mm (0.118" to 0.255")			
		Large	6.5mm to 8mm (0.255" to 0.314")			
	Mechanical Operations	1000 mating cycles				
<b>MATERIALS</b>	Connector shell - Metal	Diecast Zinc Alloy				
	Shell finish	Satin nickel or Black polyester				
	Connector shell - Thermoplastic	Thermoplastic, UL94V-0 Modified PPE Resin				
	Shell finish	Black				
	Insulators	UL94V-0 PBT Resin or Modified PPE Resin				
	Boot / Backshell	UL94V-0 Modified PPE Resin or Machined Brass				
	Finish	Black, other colours available - see page 136				
	Cable clamp (JAWS)	Standard Solder	UL94V-0 Modified PPO Resin (Black)			
	Large Solder	UL94V-0 Modified PPO Resin (Purple)				
	Cable Bushing	Santoprene				
Male Contact (Solder / Plating)	Stamped	Phosphor Bronze / Silver or Gold (Optional)				
	Machined	Brass / Silver or Gold (Optional)				
Female Contact (Solder / Plating)	Stamped	Phosphor Bronze / Tin or Gold (Optional)				
	Machined	Brass / Silver or Gold (Optional)				

Rev 6 - 03/2015

<sup>1</sup> Not suitable for domestic applications above 50V

<sup>2</sup> Approximate weight only, does not include packaging. Please contact us for exact weight for shipping purposes.

# XLR Connectors

## AC/AX Series XLR Metal Chassis Mount Connectors



# AC/AX SERIES XLR METAL CHASSIS MOUNT CONNECTORS

The metal chassis mount connectors are designed for the audio user where durability, reliability and strength across a wide range of applications are important. All products are manufactured to the highest quality standards and will withstand the harshest environments. This range complies with IEC268-12 and AES 14-1992 standards. CSA File Number 68598

### Features

- The "D" size housing can be either front or rear mounted using the same panel cutout.
- The "P" size housing is the original wide flange front mounting XLR connector. "PN" is the original narrow flange front mounting male connector.
- A leading first mate last break socket contact is standard on all female connectors (Pin 1).
- Solder cup or Vertical PCB versions.
- Connectors are fitted with a grounding system for RFI shielding applications.
- Available in 3, 4, 5, 6A and 7 contact arrangements.
- Compatible with all other XLR brands.

### Options

- Solder Bucket termination
- Vertical PCB contacts
- Zinc Diecast Shell - Satin Nickel Finish
- Zinc Diecast Shell - Black Polyester Finish
- Gold, Silver or Tin Plated Contacts
- Bulk Packaging
- Single Bag packs
- Precision machined contacts
- Cost effective stamped contacts on 3 pole
- Latchless versions (Non-Latching) (Female only)

**Note:** A ground tag is standard on all AC "Z" series connectors. Although the ground tag is intended for RFI shielding applications, Amphenol cannot guarantee its effectiveness in all cases.

The non-conductive Black polyester finish insulates the ground tag from the shell and should not be used in applications requiring ground contact to the shell.

### Ordering Codes

We have listed the more common ordering codes in each section. For further options please refer to the part number breakdown charts. Please contact us if you need any further assistance.

### Simple steps to guide you in using this catalogue

- 1) Identify the product group listed in Contents on page 1 and go directly to that page number.
- 2) Each product group cover page then details information and options available.
- 3) Refer to the product detail pages and identify the product you require pictorially.
- 4) Read the product description column for the products standard features.
- 5) Use variations column to determine your choice.
- 6) Identify part number.
- 7) In the event the particular option you require is not listed please refer to the part number breakdown page at the end of each section.
- 8) Please contact us directly if you have any further problems.

# XLR Connectors

## AC/AX Series XLR Metal Chassis Mount Connectors









### Features:

- Zinc Diecast Shell.
- D size housing can be front or rear mounted using the same panel cutout.
- Solder Bucket connections.
- Vertical PCB mounting.
- Precision machined or Stamped contacts (3 pin only).
- Leading first mate last break socket contact.
- Positive latch lock system.
- M3 threaded holes (Optional).

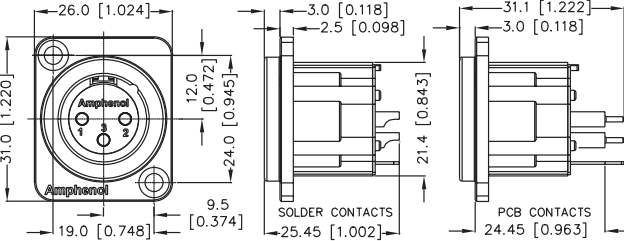
**Options:** Stamped contacts (3 contact only), Gold plated contacts, Vertical PCB contacts, Black finish, Non-Latching (Female only), Bulk Pack.

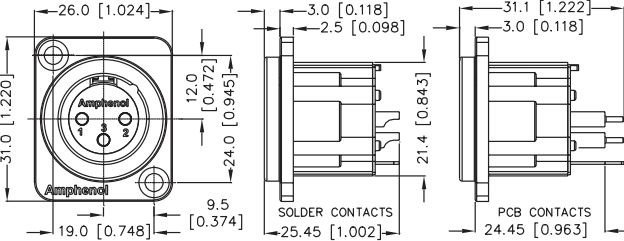
**Part Number Breakdown: Page 20**

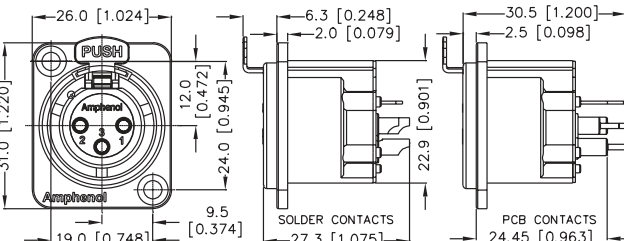

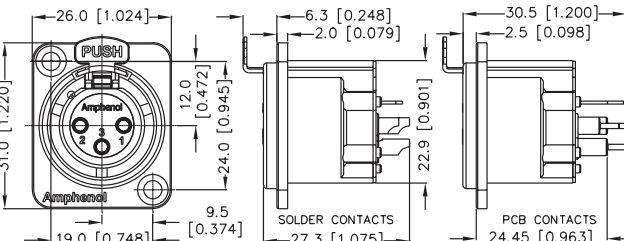



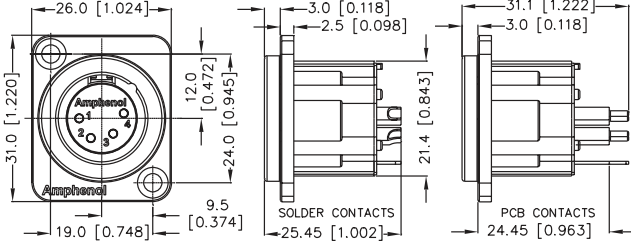

**Specifications: Page 26**

PRODUCT	DRAWING Dimensions in mm (inches)	DESCRIPTION	VARIATIONS	PART NO.
		XLR 3 pole male, D Flange, Machined contacts, Nickel Finish	Standard	<a href="#">AX3MD</a>
		M3 Threaded Holes	<a href="#">AX3MD-M3</a>	
		Vertical PCB	<a href="#">AX3MDV</a>	
		M3 Threaded Holes	<a href="#">AX3MDV-M3</a>	
		XLR 3 pole male, D Flange, Machined contacts, Black Finish	Standard	<a href="#">AX3MDB</a>
		M3 Threaded Holes	<a href="#">AX3MDB-M3</a>	
		Gold Plated Contacts	<a href="#">AX3MDB-AU</a>	
		Vertical PCB	<a href="#">AX3MDVB</a>	
		M3 Threaded Holes	<a href="#">AX3MDVB-M3</a>	
		XLR 3 pole female, D Flange, Stamped contacts, Nickel Finish	Standard	<a href="#">AX3FD</a>
		M3 Threaded Holes	<a href="#">AX3FD-M3</a>	
		XLR 3 pole female, D Flange, Stamped contacts, Black Finish	Standard	<a href="#">AX3FDB</a>
		M3 Threaded Holes	<a href="#">AX3FDB-M3</a>	
		Gold Plated Contacts	<a href="#">AX3FDB-AU</a>	

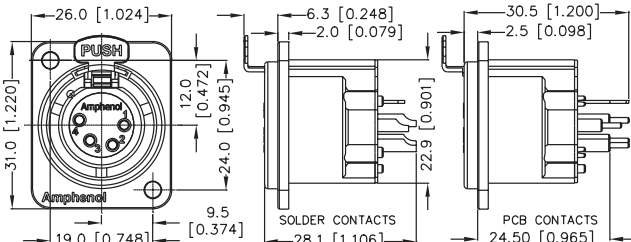

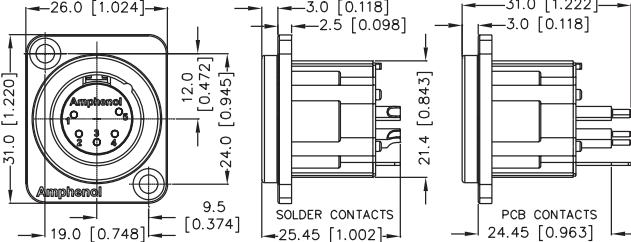

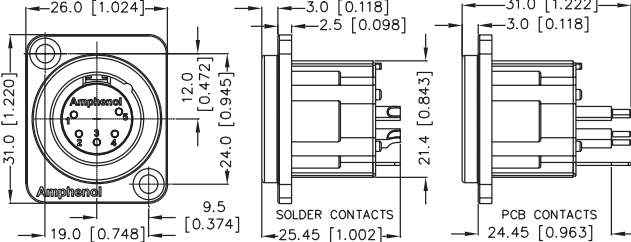





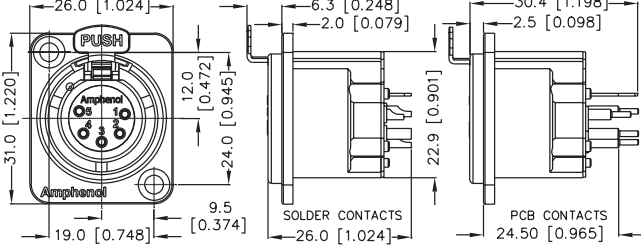

# XLR Connectors

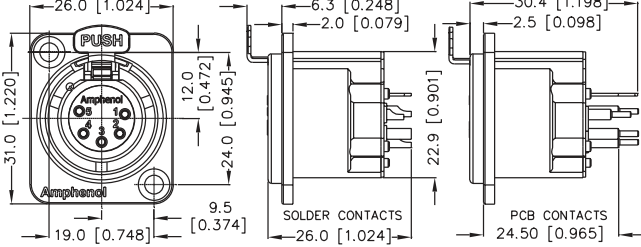
## AC/AX Series XLR Metal Chassis Mount Connectors

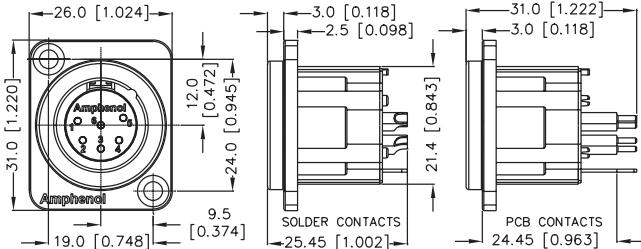
PRODUCT	DRAWING Dimensions in mm (inches)	DESCRIPTION	VARIATIONS	PART NO.
		XLR 4 pole male, D Flange, Machined contacts, Nickel Finish	Standard M3 Threaded Holes	AX4MD AX4MD-M3
		XLR 4 pole male, D Flange, Machined contacts, Black Finish	Vertical PCB M3 Threaded Holes	AX4MDV AX4MDV-M3
		XLR 4 pole female, D Flange, Machined contacts, Nickel Finish	Standard M3 Threaded Holes	AX4FD AX4FD-M3
		XLR 4 pole female, D Flange, Machined contacts, Black Finish	Vertical PCB M3 Threaded Holes	AX4FDV AX4FDV-M3
		XLR 5 pole male, D Flange, Machined contacts, Nickel Finish	Standard M3 Threaded Holes	AX5MD AX5MD-M3
		XLR 5 pole male, D Flange, Machined contacts, Black Finish	Vertical PCB M3 Threaded Holes	AX5MDV AX5MDV-M3
		XLR 5 pole male, D Flange, Machined contacts, Nickel Finish	Standard	AX5MDB
		XLR 5 pole male, D Flange, Machined contacts, Black Finish	Gold Plated Contacts Vertical PCB	AX5MDB-AU AX5MDVB

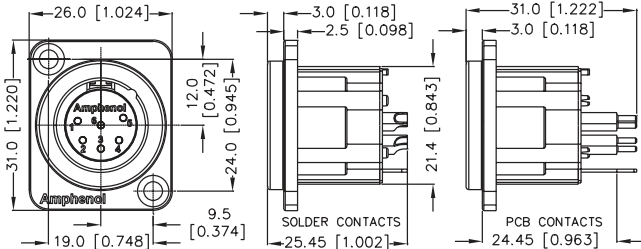
# XLR Connectors

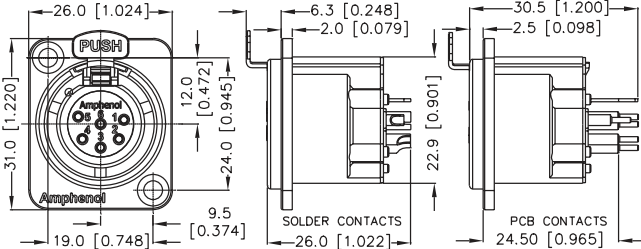
## AC/AX Series XLR Metal Chassis Mount Connectors

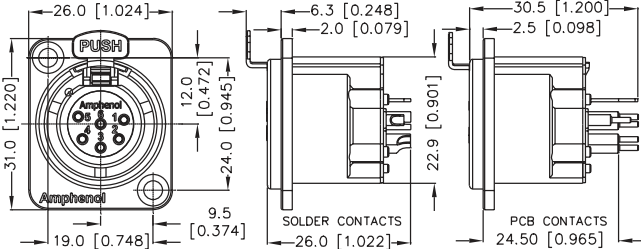
PRODUCT	DRAWING Dimensions in mm (inches)	DESCRIPTION	VARIATIONS	PART NO.
		XLR 5 pole female, D Flange, Machined contacts, Nickel Finish	Standard M3 Threaded Holes	AX5FD AX5FD-M3
		Vertical PCB M3 Threaded Holes	AX5FDV AX5FDV-M3	
		XLR 5 pole female, D Flange, Machined contacts, Black Finish	Standard Gold Plated Contacts	AX4FDB AX4FDB-AU
		Vertical PCB	AX4FDVB	
		XLR 6A pole male, D Flange, Machined contacts, Nickel Finish	Standard M3 Threaded Holes	AX6AMD AX6AMD-M3
		Vertical PCB M3 Threaded Holes	AX6AMDV AX6AMDV-M3	
		XLR 6A pole male, D Flange, Machined contacts, Black Finish	Standard Gold Plated Contacts	AX6AMDB AX6AMDB-AU
		Vertical PCB	AX6AMDVB	
		XLR 6A pole female, D Flange, Machined contacts, Nickel Finish	Standard M3 Threaded Holes	AX6AFD AX6AFD-M3
		Vertical PCB M3 Threaded Holes	AX6AFDV AX6AFDV-M3	
		XLR 6A pole female, D Flange, Machined contacts, Black Finish	Standard Gold Plated Contacts	AX6AFDB AX6AFDB-AU
		Vertical PCB	AX6AFDVB	

# XLR Connectors

AC/AX Series XLR Metal Chassis Mount Connectors

## PART NUMBER BREAKDOWN

METAL TYPE FLANGE

E. G. **AX3MDVB-AU-M3 BULK**  
**AX** (Series Prefix), **3** contacts, **M**ale, **D** Small Flange, **V**ertical PCB Contact,  
**B**lack Polyester Finish, - **AU** (Gold Plated Contacts), - **M3** Mounted Holes,  
**BULK** Packaged.

<b>SERIES PREFIX</b>	AX	=	Series Prefix
<b>CONTACT LAYOUTS</b>	3	=	3 Contacts
	4	=	4 Contacts
	5	=	5 Contacts
	6A	=	6 Contacts
<b>GENDER</b>	F	=	Female Socket Contacts
	M	=	Male Pin Contacts
<b>SHELL STYLE</b>	D	=	Small Flange (front or rear mounting)
<b>SHELL SERIES</b>	Blank	=	Solder Bucket
	V	=	Vertical PCB Contact
<b>SHELL FINISH<sup>1</sup></b>	Blank	=	Nickel Plated Finish
	B	=	Black Polyester Finish
<b>CONTACT PLATING<sup>2</sup></b>	Blank	=	Standard Plating
	AU	=	Gold Plated
<b>MOUNTING HOLES</b>	Blank	=	Through Holes
	M3	=	M3 Threaded Holes
<b>PACKAGING</b>	Blank	=	Individual Bags
	BULK	=	Bulk Packed

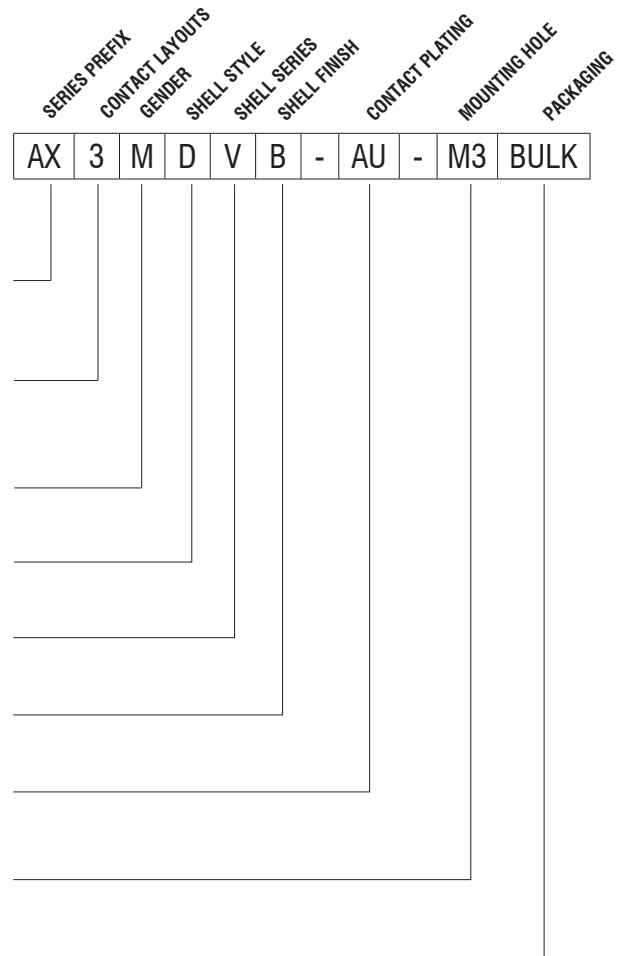

**Note:**

<sup>1</sup> Ground contacts are not supplied with the black polyester finish shell option.

<sup>3</sup> Non-Latching Versions (Female) available - Please contact us for part number options.

# XLR Connectors

## AC/AX Series XLR Metal Chassis Mount Connectors



### Features:

- Zinc Diecast Shell.
- D size housing can be front or rear mounted using the same panel cutout.
- Solder Bucket connections.
- Precision machined or Stamped contacts (3 pin only).
- Leading first mate last break socket contact.
- Positive latch lock system.

**Options:** Stamped contacts (3 contact only), Gold plated contacts, Black finish, Non-Latching (Female only), Bulk Pack.

**Part Number Breakdown:** [Page 25](#)

**Specifications:** [Page 26](#)











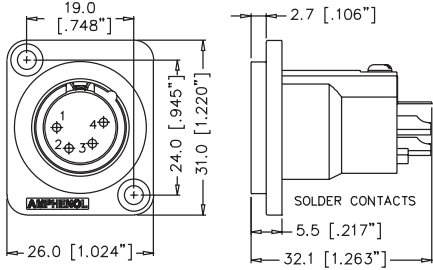

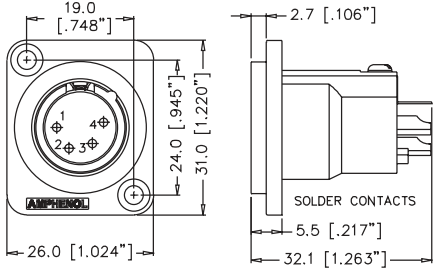

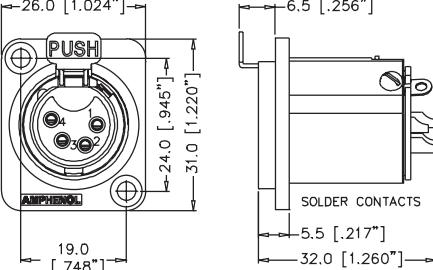
**PCB Footprints:** [Page 27](#)

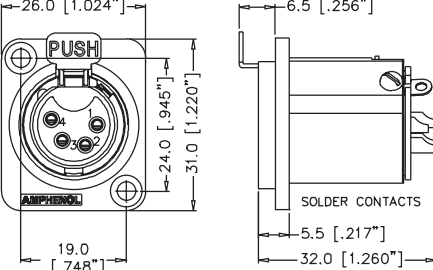
**Panel Cutouts:** [Page 27](#)

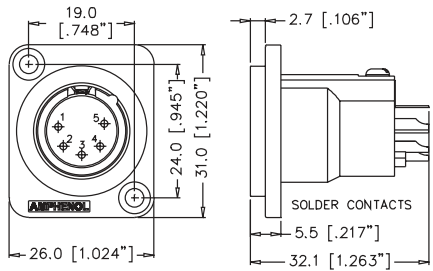
PRODUCT - FIGURE	DRAWING	Dimensions in mm (inches)	DESCRIPTION	VARIATIONS	PART NUMBER
			XLR 3 pole male, D Flange, Machined contacts, Nickel Finish	Standard	<a href="#">AC3MMDZ</a>
				Bulk Pack	<a href="#">AC3MMDZ BULK</a>
			XLR 3 pole male, D Flange, Machined contacts, Black Finish	Standard	<a href="#">AC3MMDZB</a>
				Gold Plated Contacts	<a href="#">AC3MMDZB-AU</a>
			XLR 3 pole male, D Flange, Stamped contacts, Nickel Finish	Standard	<a href="#">AC3MDZ</a>
				Bulk Pack	<a href="#">AC3MDZ BULK</a>
			XLR 3 pole male, D Flange, Stamped contacts, Black Finish	Standard	<a href="#">AC3MDZB</a>
				Gold Plated Contacts	<a href="#">AC3MDZB-AU</a>
			XLR 3 pole female, D Flange, Stamped contacts, Nickel Finish	Standard	<a href="#">AC3FDZ</a>
				Bulk Pack	<a href="#">AC3FDZ BULK</a>
			XLR 3 pole female, D Flange, Stamped contacts, Black Finish	Standard	<a href="#">AC3FDZB</a>
				Gold Plated Contacts	<a href="#">AC3FDZB-AU</a>

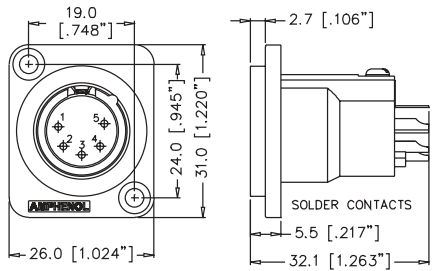

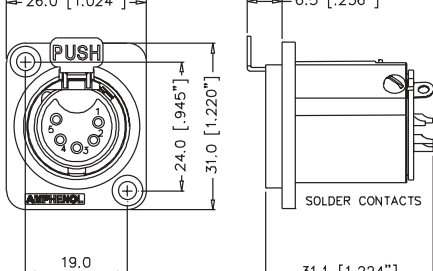

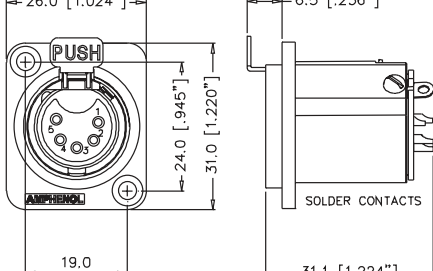





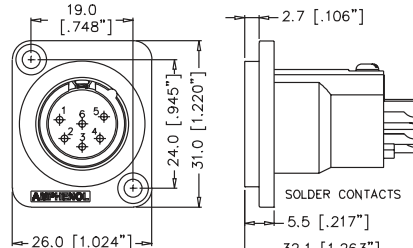

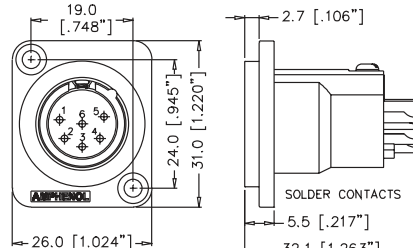

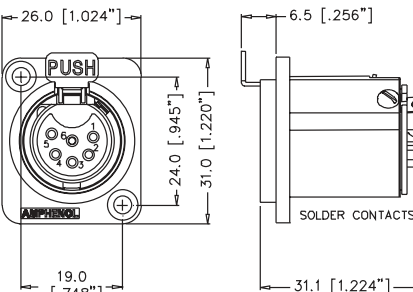
# XLR Connectors

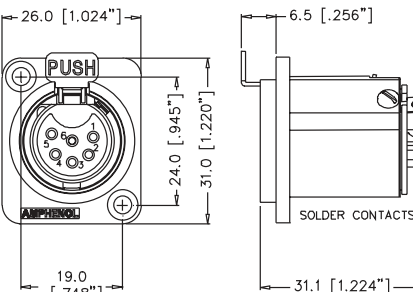
## AC/AX Series XLR Metal Chassis Mount Connectors

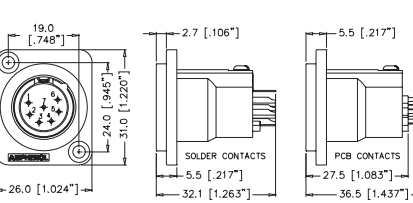
PRODUCT - FIGURE	DRAWING	Dimensions in mm (inches)	DESCRIPTION	VARIATIONS	PART NUMBER
		<p>19.0 [.748"]</p> <p>24.0 [.945"]</p> <p>31.0 [1.220"]</p> <p>26.0 [1.024"]</p> <p>2.7 [.106"]</p> <p>SOLDER CONTACTS</p> <p>5.5 [.217"]</p> <p>32.1 [1.263"]</p>	XLR 4 pole male, D Flange, Machined contacts, Nickel Finish	Standard	<a href="#">AC4MDZ</a>
			Bulk Pack	<a href="#">AC4MDZ BULK</a>	
		<p>19.0 [.748"]</p> <p>24.0 [.945"]</p> <p>31.0 [1.220"]</p> <p>26.0 [1.024"]</p> <p>2.7 [.106"]</p> <p>SOLDER CONTACTS</p> <p>5.5 [.217"]</p> <p>32.1 [1.263"]</p>	XLR 4 pole male, D Flange, Machined contacts, Black Finish	Standard	<a href="#">AC4MDZB</a>
			Gold Plated Contacts	<a href="#">AC4MDZB-AU</a>	
		<p>26.0 [1.024"]</p> <p>24.0 [.945"]</p> <p>31.0 [1.220"]</p> <p>19.0 [.748"]</p> <p>6.5 [.256"]</p> <p>SOLDER CONTACTS</p> <p>5.5 [.217"]</p> <p>32.0 [1.260"]</p>	XLR 4 pole female, D Flange, Machined contacts, Nickel Finish	Standard	<a href="#">AC4FDZ</a>
			Bulk Pack	<a href="#">AC4FDZ BULK</a>	
		<p>26.0 [1.024"]</p> <p>24.0 [.945"]</p> <p>31.0 [1.220"]</p> <p>19.0 [.748"]</p> <p>6.5 [.256"]</p> <p>SOLDER CONTACTS</p> <p>5.5 [.217"]</p> <p>32.0 [1.260"]</p>	XLR 4 pole female, D Flange, Machined contacts, Black Finish	Standard	<a href="#">AC4FDZB</a>
			Gold Plated Contacts	<a href="#">AC4FDZB-AU</a>	
		<p>19.0 [.748"]</p> <p>24.0 [.945"]</p> <p>31.0 [1.220"]</p> <p>26.0 [1.024"]</p> <p>2.7 [.106"]</p> <p>SOLDER CONTACTS</p> <p>5.5 [.217"]</p> <p>32.1 [1.263"]</p>	XLR 5 pole male, D Flange, Machined contacts, Nickel Finish	Standard	<a href="#">AC5MDZ</a>
			Bulk Pack	<a href="#">AC5MDZ BULK</a>	
		<p>19.0 [.748"]</p> <p>24.0 [.945"]</p> <p>31.0 [1.220"]</p> <p>26.0 [1.024"]</p> <p>2.7 [.106"]</p> <p>SOLDER CONTACTS</p> <p>5.5 [.217"]</p> <p>32.1 [1.263"]</p>	XLR 5 pole male, D Flange, Machined contacts, Black Finish	Standard	<a href="#">AC5MDZB</a>
			Gold Plated Contacts	<a href="#">AC5MDZB-AU</a>	
		<p>26.0 [1.024"]</p> <p>24.0 [.945"]</p> <p>31.0 [1.220"]</p> <p>19.0 [.748"]</p> <p>6.5 [.256"]</p> <p>SOLDER CONTACTS</p> <p>5.5 [.217"]</p> <p>31.1 [1.224"]</p>	XLR 5 pole female, D Flange, Machined contacts, Nickel Finish	Standard	<a href="#">AC5FDZ</a>
			Bulk Pack	<a href="#">AC5FDZ BULK</a>	
		<p>26.0 [1.024"]</p> <p>24.0 [.945"]</p> <p>31.0 [1.220"]</p> <p>19.0 [.748"]</p> <p>6.5 [.256"]</p> <p>SOLDER CONTACTS</p> <p>5.5 [.217"]</p> <p>31.1 [1.224"]</p>	XLR 5 pole female, D Flange, Machined contacts, Black Finish	Standard	<a href="#">AC5FDZB</a>
			Gold Plated Contacts	<a href="#">AC5FDZB-AU</a>	

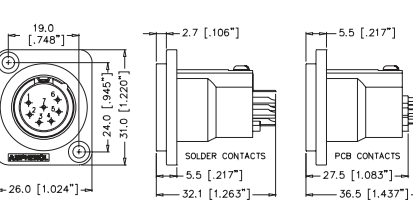
# XLR Connectors

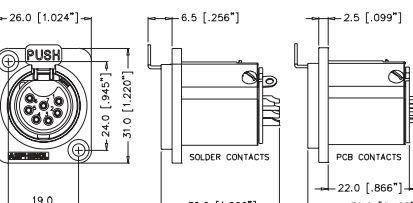
## AC/AX Series XLR Metal Chassis Mount Connectors

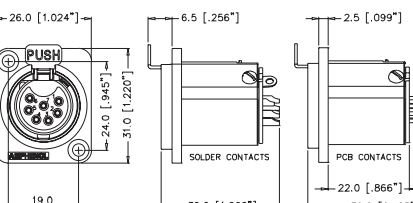
PRODUCT - FIGURE	DRAWING	Dimensions in mm (inches)	DESCRIPTION	VARIATIONS	PART NUMBER
			XLR 6A pole male, D Flange, Machined contacts, Nickel Finish	Standard	<a href="#">AC6AMDZ</a>
				Bulk Pack	<a href="#">AC6AMDZ BULK</a>
			XLR 6A pole male, D Flange, Machined contacts, Black Finish	Standard	<a href="#">AC6AMDZB</a>
				Gold Plated Contacts	<a href="#">AC6AMDZB-AU</a>
			XLR 6A pole female, D Flange, Machined contacts, Nickel Finish	Standard	<a href="#">AC6AFDZ</a>
				Bulk Pack	<a href="#">AC6AFDZ BULK</a>
			XLR 6A pole female, D Flange, Machined contacts, Black Finish	Standard	<a href="#">AC6AFDZB</a>
				Gold Plated Contacts	<a href="#">AC6AFDZB-AU</a>
			XLR 7 pole male, D Flange, Gold Plated Machined contacts, Nickel Finish	Standard	<a href="#">AC7MDZ</a>
				Vertical PCB	<a href="#">AC7MDZV</a>
				Bulk Pack	<a href="#">AC7MDZ BULK</a>
			XLR 7 pole male, D Flange, Gold Plated Machined contacts, Black Finish	Standard	<a href="#">AC7MDZB</a>
				Vertical PCB	<a href="#">AC7MDZVB</a>
			XLR 7 pole female, D Flange, Gold Plated Machined contacts, Nickel Finish	Standard	<a href="#">AC7FDZ</a>
				Vertical PCB	<a href="#">AC7FDZV</a>
				Bulk Pack	<a href="#">AC7FDZ BULK</a>
			XLR 7 pole female, D Flange, Gold Plated Machined contacts, Black Finish	Standard	<a href="#">AC7FDZB</a>
				Vertical PCB	<a href="#">AC7FDZVB</a>

# XLR Connectors

## AC/AX Series XLR Metal Chassis Mount Connectors



### Features:

- Zinc Diecast shell.
- The P size housing is the original wide flange front mounting XLR connector. PN is the original narrow, front mounting male connector.
- Solder Bucket connections.
- Precision Machined or Stamped contacts (3 pin only).
- Leading first mate last break socket contact.
- Positive latch lock system.

**Options:** Stamped contacts (3 contact only), Gold plated contacts, Black Finish, Non-Latching (Female only), Bulk Pack.

**Part Number Breakdown: Page 20    Specifications: Page 26**  
**PCB Footprints: Page 27    Panel Cutouts: Page 27**

PRODUCT - FIGURE	DRAWING	Dimensions in mm (inches)	DESCRIPTION	POLES	PART NUMBER
			XLR male, Narrow flange, Machined contacts	3	<a href="#">AC3MMPNZ</a>
			XLR male, Narrow flange, Stamped contacts,	3	<a href="#">AC3MPNZ</a>
		4		<a href="#">AC4MPNZ</a>	
		5		<a href="#">AC5MPNZ</a>	
		6		<a href="#">AC6AMPNZ</a>	
		7		<a href="#">AC7MPNZ</a>	
			XLR male, Wide flange, Machined contacts	3	<a href="#">AC3MMP</a>
			XLR male, Wide flange, Stamped contacts	3	<a href="#">AC3MP</a>
		4		<a href="#">AC4MP</a>	
		5		<a href="#">AC5MP</a>	
		6		<a href="#">AC6AMP</a>	
		7		<a href="#">AC7MP</a>	
			XLR female, Wide flange, Stamped contacts	3	<a href="#">AC3FPZ</a>
		4		<a href="#">AC4FPZ</a>	
		5		<a href="#">AC5FPZ</a>	
		6		<a href="#">AC6AFPZ</a>	
		7		<a href="#">AC7FPZ</a>	

\*Black finish available on special request please contact factory.

# PART NUMBER BREAKDOWN

## METAL TYPE FLANGE

E. G. **AC3MMPNZVB-AU BULK**  
**AC** (Series Prefix), **3** contacts, **Male**, **M**achined Contacts, **PN** (Narrow Flange), **Z** (Metal Chassis Series), **B**lack Polyester Finish, **- AU** (Gold Plated Contacts), **Bulk** Packaged.

<b>SERIES PREFIX</b>	AC	=	Series Prefix
<b>CONTACT LAYOUTS</b>	3	=	3 Contacts
	4	=	4 Contacts
	5	=	5 Contacts
	6A	=	6 Contacts
	7	=	7 Contacts
<b>GENDER</b>	F	=	Female Socket Contacts
	M	=	Male Pin Contacts
<b>MACHINED CONTACTS<sup>1</sup></b>	Blank	=	Stamped Contacts
	M	=	Machined Contacts (Applicable 3 male pin contacts only)
<b>SHELL STYLE</b>	D	=	Small Flange (front or rear mounting)
	P	=	Large Shell with Wide Flange
	PN	=	Large Shell with Narrow Flange (male only)
<b>SHELL SERIES</b>	Blank	=	Male P Shell Style Only
	Z	=	Metal Chassis Series
<b>SHELL FINISH<sup>2</sup></b>	Blank	=	Nickel Plated Finish
	B	=	Black Polyester Finish
<b>CONTACT PLATING<sup>3</sup></b>	Blank	=	Standard Plating (Silver or Tin - refer to Standard Data)
	AU	=	Gold Plated
<b>PACKAGING</b>	Blank	=	Individual Bags
	BULK	=	Bulk Packed

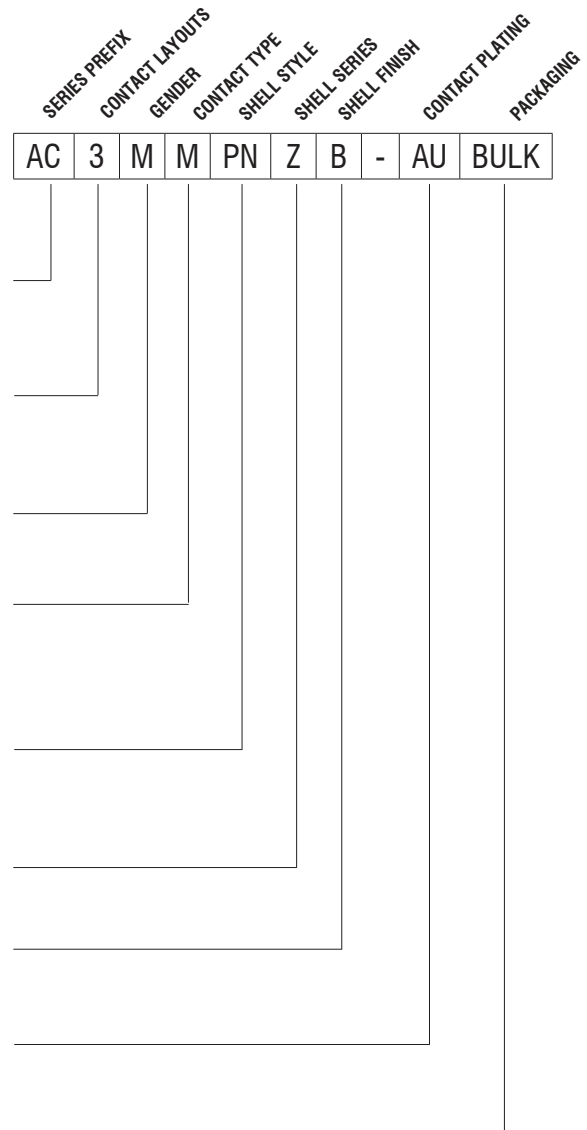

**Note:**

<sup>1</sup> 4 - 7 contact connectors have machined contacts and grounding as standard. They are not available in stamped contacts.

<sup>2</sup> Ground contacts are not supplied with the black polyester finish shell option.

<sup>3</sup> 7 Contact is gold plated as standard.

<sup>4</sup> Non-Latching Versions (Female) available - Please contact us for part number options.



# XLR Connectors

AC/AX Series XLR Metal Chassis Mount Connectors

## STANDARD DATA AC / AX SERIES CHASSIS - METAL “Z”

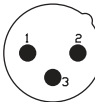
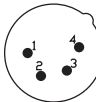
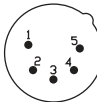
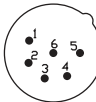
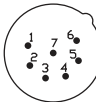
		VALUE				
<b>GENERAL CHARACTERISTICS</b>	Number of contacts	3	4	5	6A	7
	Contact Arrangement (Front view of pin inserts)					
	Termination	Solder Bucket / Printed Circuit Board (PCB)				
	Max. Wire Gauge - Stranded wire:					
	Solder	14AWG	16AWG	18AWG	18AWG	20AWG
	Printed Circuit Board - PCB	N/A	N/A	N/A	N/A	N/A
Flammability rating of plastics	UL94V-0					
Environmental	Complies with EU RoHS 2 Directive 2011/65/EU					
<b>ELECTRICAL CHARACTERISTICS</b>	Service Voltage RMS	133V <sup>1)</sup>				
	Test Voltage AC RMS	1400V				
	Current carrying capacity:					
	Solder	15A	10A	7.5A	7.5A	5A
	Printed Circuit Board (PCB)	15A	10A	7.5A	7.5A	5A
	Typical Contact Resistance	≤3mΩ				
Insulation Resistance	≥1000MΩ					
<b>CLIMATIC CHARACTERISTICS</b>	Protection Class	IP40				
	Operating Temperature	-25 °C to +75 °C (-13°F to +167°F)				
<b>MECHANICAL CHARACTERISTICS</b>	Weight - Metal <sup>2)</sup>	31g (0.068lb)	32g (0.070lb)	33g (0.072lb)	33g (0.072lb)	33g (0.072lb)
	Mechanical Operations	1000 mating cycles				
<b>MATERIALS</b>	Connector Shell	Diecast Zinc Alloy				
	Shell Finish	Satin Nickel or Black Polyester				
	Insulators	PA66 30% Glass Filled Resin				
	Male Contact					
	Stamped Solder and PCB-(Material/Plating)	Phosphor Bronze / Silver or Gold (optional)				
	Machined Solder-(Material/Plating)	Brass / Silver or Gold (optional)				
	Female Contact					
Stamped Solder and PCB-(Material/Plating)	Phosphor Bronze / Tin or Gold (optional)					
Machined Solder-(Material/Plating)	Brass / Silver or Gold (Optional)					

Rev 4 - 02/2020

<sup>1)</sup> Not suitable for domestic applications above 50V

<sup>2)</sup> Approximate weight only, does not include packaging. Please contact us for exact weight for shipping purposes.

# AC / AX SERIES CHASSIS METAL "Z"

## PCB FOOTPRINTS STRAIGHT (V) CONNECTOR SIDE OF PCB

○  $\varnothing 1.2\text{mm}(.05")$  + Panel Cutout CL

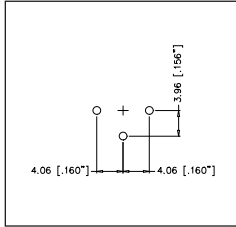

**AC3MM\*ZV**

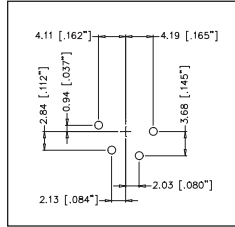

**AC4F\*ZV**

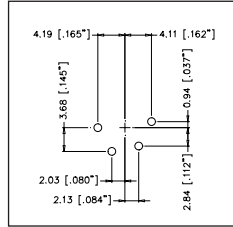

**AC4M\*ZV**

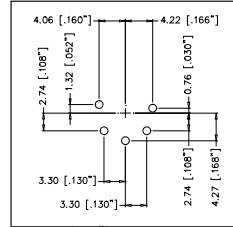

**AC5F\*ZV**

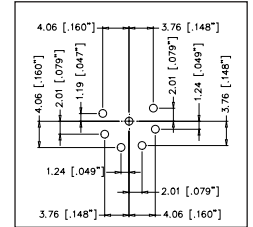

**AC7M\*ZV**

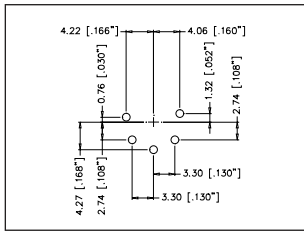

**AC5M\*ZV**

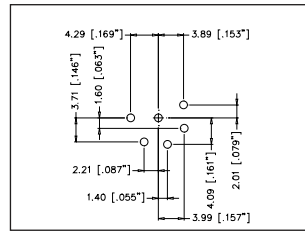

**AC6AF\*ZV**

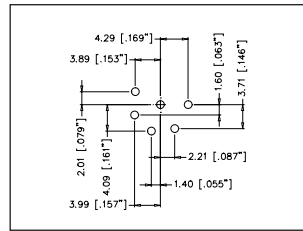

**AC6AM\*ZV**

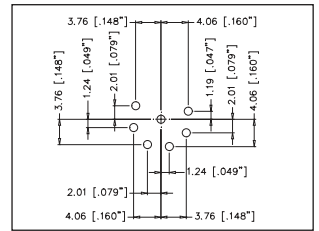

**AC7F\*ZV**

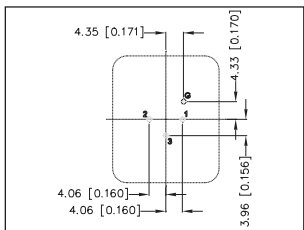

**AX3FD**

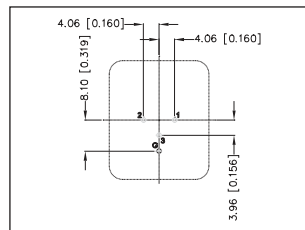

**AX3MD**

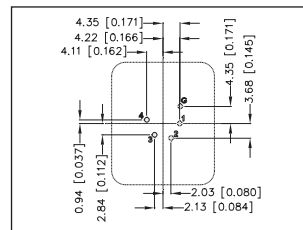

**AX4FD**

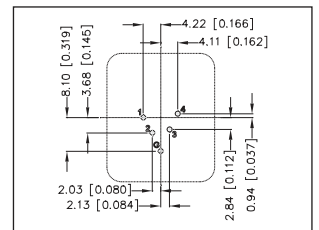

**AX4MD**

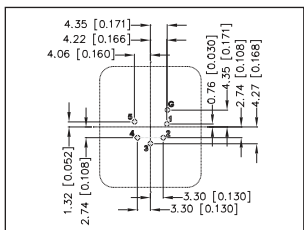

**AX5FD**

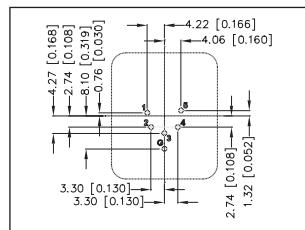

**AX5MD**

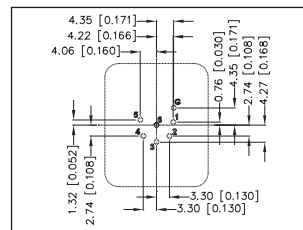

**AX6AFD**

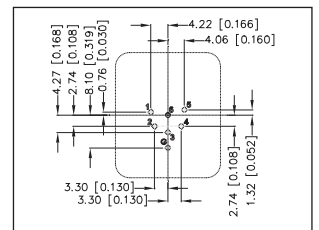

**AX6AMD**

## PANEL CUTOUT DIMENSIONS FRONT VIEW

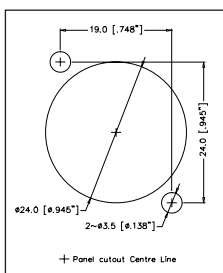

**AC\*FDZ / AX\*FD**

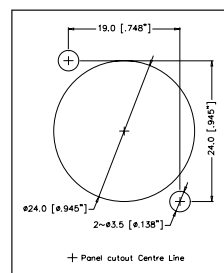

**AC\*MDZ / AX\*MD**

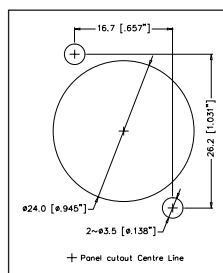

**AC\*FPZ**

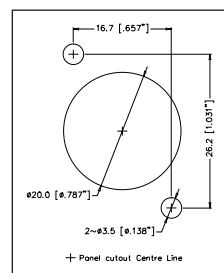

**AC\*MP**

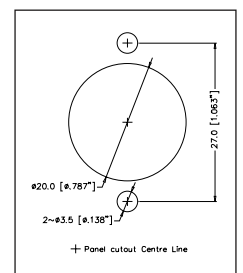

**AC\*MPNZ**

# XLR Connectors

## AC Series XLR PCB Chassis Mount Connectors



# AC SERIES XLR PCB CHASSIS MOUNT CONNECTORS

The AC series, A and B type XLR chassis receptacles have been designed and manufactured with the Original Equipment Manufacturers' (OEM) needs in mind. The compact shell design allows a significant space saving over the traditional 'D' type shell. Gold plated contacts improve the performance, ensuring a reliable contact and the unique grounding link options offer flexibility in design.

### Features

- A leading first mate last break socket contact is standard on all female connectors (Pin 1).
- Vertical and Horizontal PCB versions available.
- Latching and Non-latching versions available.
- A range of different grounding options are available including:
  - Mating connector shell to Pin 1
  - Mating connector shell to Chassis
  - Mating connector shell to pin 1 to Chassis
- A type is available in 3, 4 or 5 contacts.
- B type is available in 3 contact only.
- Compatible with all other XLR brands.
- Metal Mounting Flange (B type)

### Options

- Vertical PCB contacts
- Horizontal PCB contacts
- Precision Machined Pin contacts
- Cost effective Stamped Socket contacts
- Gold Plated contacts (Standard)
- Silver Plated contacts (Optional)
- Bulk Packaging
- Integrated Switch

### Ordering Codes

We have listed the more common ordering codes in each section. For further options please refer to the part number breakdown charts. Please contact us if you need any further assistance.

### Simple steps to guide you in using this catalogue

- 1) Identify the product group listed in Contents on page 1 and go directly to that page number.
- 2) Each product group cover page then details information and options available.
- 3) Refer to the product detail pages and identify the product you require pictorially.
- 4) Read the product description column for the products standard features.
- 5) Use variations column to determine your choice.
- 6) Identify part number.
- 7) In the event the particular option you require is not listed please refer to the part number breakdown page at the end of each section.
- 8) Please contact us directly if you have any further problems.

### A TYPE

#### Features:

- Thermoplastic Shell
- Contact layouts in 3,4 or 5
- Industry standard PCB footprints.
- Vertical or Horizontal PCB mounting.
- Precision machined pin contacts.
- Gold plated contacts.
- Leading first mate last break socket contact.
- Bulk packed in trays, 100 to a box as standard.
- Positive latch lock system.

**Options:** Vertical or Horizontal PCB, Various grounding methods, Latching or Non-Latching.

**Part Number Breakdown:** [Page 36](#) **Specifications:** [Page 39](#)

**PCB Footprints:** [Page 40](#)

**Panel Cutouts:** [Page 41](#)

**Recommended Fastener:** [Page 134](#)



PRODUCT - FIGURE	DRAWING	Dimensions in mm (inches)	DESCRIPTION	GROUND LINK VARIATIONS	PART NUMBER
		25.4 [ .998" ] 19.5 [ .768" ] 19.8 [ .780" ] 2.7 [ .106" ] 12.5 [ .492" ] 19.8 [ .780" ]	XLR 3 pole male, Vertical PCB, Gold Plated Contacts, Bulk Pack	No Ground Link	AC3MAH-AU-PRE
		25.4 [ .998" ] 19.5 [ .768" ] 19.8 [ .780" ] 2.7 [ .106" ] 12.5 [ .492" ] 19.8 [ .780" ]	XLR 3 pole male, Horizontal PCB, Gold Plated Contacts, Bulk Pack	Pin 1 to Chassis to Mating connector shell	AC3MAH1-AU-PRE
		25.4 [ .998" ] 19.5 [ .768" ] 19.8 [ .780" ] 2.7 [ .106" ] 12.5 [ .492" ] 19.8 [ .780" ]	XLR 3 pole male, Horizontal PCB, Gold Plated Contacts, Bulk Pack	Mating connector shell to Chassis - Pin 1 sep. Ground	AC3MAH2-AU-PRE
		25.4 [ .998" ] 19.5 [ .768" ] 19.8 [ .780" ] 2.7 [ .106" ] 12.5 [ .492" ] 19.8 [ .780" ]	XLR 3 pole male with integrated switch, Horizontal PCB, Gold Plated Contacts, Bulk Pack	Mating connector shell to Chassis to PCB, Pin 1 sep. Ground	AC3MAH4-SW-B
		25.4 [ .998" ] 19.5 [ .768" ] 19.8 [ .780" ] 2.7 [ .106" ] 3.5 [ .138" ] 12.5 [ .492" ] 19.8 [ .780" ]	XLR 3 pole male, Vertical PCB, Gold Plated Contacts, Bulk Pack	No Ground Link	AC3MAV-AU-PRE











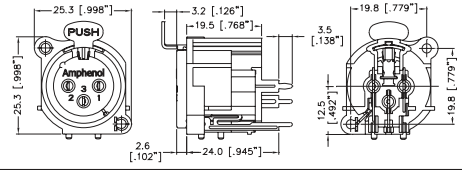

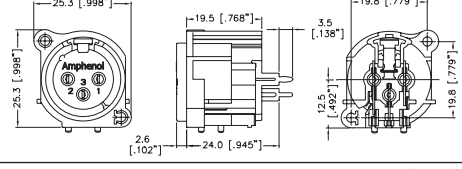

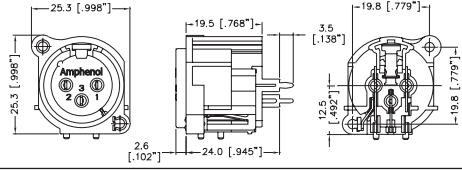

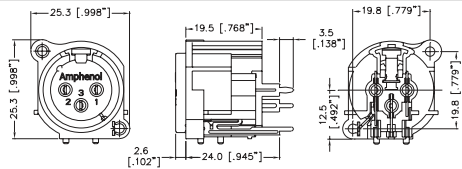
# XLR Connectors

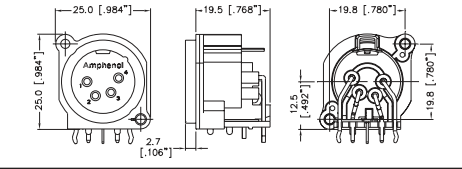
## AC Series XLR PCB Chassis Mount Connectors

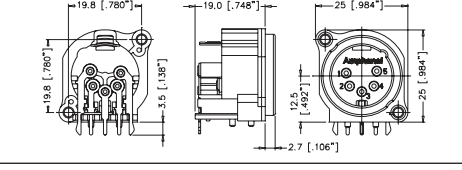
PRODUCT - FIGURE	DRAWING	Dimensions in mm (inches)	DESCRIPTION	GROUND LINK VARIATIONS	PART NUMBER
			XLR 3 pole male, Vertical PCB, Gold Plated Contacts, Bulk Pack	Mating connector shell to Chassis - Pin 1 sep. Ground	AC3MAV2-AU-PRE
			XLR 3 pole male, Solder Buckets, Gold Plated Contacts, Bulk Pack	No Ground Link	AC3MA-AU-B
			XLR 3 pole female, Horizontal PCB, Latching Type, Gold Plated Contacts, Bulk Pack	No Ground Link	AC3FAH-AU-PRE
			XLR 3 pole female, Horizontal PCB, Latching Type, Gold Plated Contacts, Bulk Pack	Pin 1 to Chassis to Mating connector shell	AC3FAH1-AU-PRE
			XLR 3 pole female, Horizontal PCB, Latching Type, Gold Plated Contacts, Bulk Pack	Mating connector shell to Chassis - Pin 1 sep. Ground	AC3FAH2-AU-PRE
			XLR 3 pole female, Horizontal PCB, Non-Latching Type Gold Plated Contacts, Bulk Pack	No Ground Link	AC3FAHL-AU-PRE
			XLR 3 pole female, Horizontal PCB, Non-Latching Type Gold Plated Contacts, Bulk Pack	Pin 1 to Chassis to mating connector shell	AC3FAHL1-AU-PRE
			XLR 3 pole female, Horizontal PCB, Non-Latching Type Gold Plated Contacts, Bulk Pack	Mating connector shell to Chassis - Pin 1 sep. Ground.	AC3FAHL2-AU-PRE
			XLR 3 pole female, Vertical PCB, Latching Type, Gold Plated Contacts, Bulk Pack	No Ground Link	AC3FAV-AU-PRE
			XLR 3 pole female, Vertical PCB, Latching Type, Gold Plated Contacts, Bulk Pack	Pin 1 to Chassis to Mating connector shell	AC3FAV1-AU-PRE

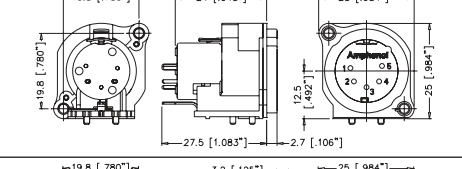
# XLR Connectors

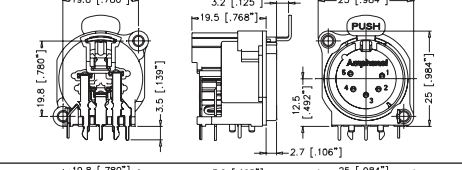
## AC Series XLR PCB Chassis Mount Connectors

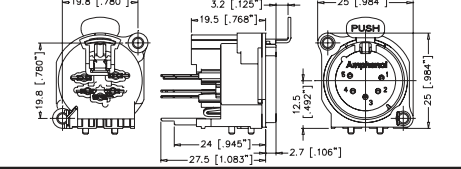
PRODUCT - FIGURE	DRAWING	Dimensions in mm (inches)	DESCRIPTION	GROUND LINK VARIATIONS	PART NUMBER
			XLR 3 pole female, Vertical PCB, Latching Type, Gold Plated Contacts, Bulk Pack	Mating connector shell to Chassis - Pin 1 sep. Ground.	AC3FAV2-AU-PRE
			XLR 3 pole female, Vertical PCB, Non-Latching Type, Gold Plated Contacts, Bulk Pack	No Ground Link	AC3FAVL-AU-PRE
			XLR 3 pole female, Vertical PCB, Non-Latching Type, Gold Plated Contacts, Bulk Pack	Pin 1 to Chassis to Mating connector shell	AC3FAVL1-AU-PRE
			XLR 3 pole female, Vertical PCB, Non-Latching Type, Gold Plated Contacts, Bulk Pack	Mating connector shell to Chassis - Pin 1 sep. Ground.	AC3FAVL2-AU-PRE
			XLR 4 pole male, Horizontal PCB, Gold Plated Contacts, Bulk Pack	Mating connector shell to Chassis - Pin 1 sep. Ground	AC4MAH-AU-B
			XLR 5 pole male, Horizontal PCB, Gold Plated Contacts, Bulk Pack	Mating connector shell to Chassis to PCB, Pin 1 sep. Ground	AC5MAH-AU-B
			XLR 5 pole male, Vertical PCB, Gold Plated Contacts, Bulk Pack	Mating connector shell to Chassis to PCB, Pin 1 sep. Ground	AC5MAV-AU-B
			XLR 5 pole female, Horizontal PCB, Gold Plated Contacts, Bulk Pack	Mating connector shell to Chassis to PCB, Pin 1 sep. Ground	AC5FAH-AU-B
			XLR 5 pole female, Vertical PCB, Gold Plated Contacts, Bulk Pack	Mating connector shell to Chassis to PCB, Pin 1 sep. Ground	AC5FAV-AU-B

# XLR Connectors

## AC Series XLR PCB Chassis Mount Connectors



# B TYPE

### Features:

- Thermoplastic Shell with Metal Mounting Flange
- Contact layouts in 3 or 5
- Industry standard PCB footprints
- Improved grounding performance
- Vertical or Horizontal PCB mounting
- Precision machined pin contacts
- Gold plated contacts
- Leading first mate last break socket contact
- Bulk packed in trays, 100 to a box as standard
- Positive latch lock system

**Options:** Silver plated contacts, Vertical or Horizontal PCB, Various grounding methods, Latching or Non-Latching.

**Part Number Breakdown:** [Page 36](#)   **Specifications:** [Page 39](#)  
**PCB Footprints:** [Page 40](#)   **Panel Cutouts:** [Page 41](#)  
**Recommended Fastener:** [Page 134](#)

PRODUCT - FIGURE	DRAWING	Dimensions in mm (inches)	DESCRIPTION/ GROUND LINK	MOUNTING FLANGE VARIATIONS	PART NUMBER
		25.3 [.996"] 19.5 [.768"] 19.8 [.780"] 12.5 [.492"] 2.7 [.106"] 3.5 [.139"]	XLR 3 pole male, Horizontal PCB, Gold Plated Contacts, Bulk Pack No Ground Link	Nickel Finish	AC3MBH-AU-PRE
		25.3 [.996"] 19.5 [.768"] 19.8 [.780"] 12.7 [.500"] 2.7 [.106"] 3.5 [.139"]	XLR 3 pole male, Horizontal PCB, Gold Plated Contacts, Bulk Pack Pin 1 to Chassis to Mating connector shell	Nickel Finish	AC3MBH1-AU-PRE
		25.3 [.996"] 19.5 [.768"] 19.8 [.780"] 12.5 [.492"] 2.7 [.106"] 3.5 [.136"]	XLR 3 pole male, Horizontal PCB, Gold Plated Contacts, Bulk Pack Mating connector shell to Chassis - Pin 1 sep. Ground	Nickel Finish	AC3MBH2-AU-PRE
		25.3 [.996"] 19.5 [.768"] 19.8 [.780"] 12.5 [.492"] 2.7 [.106"] 3.5 [.139"]	XLR 3 pole male, Horizontal PCB, Gold Plated Contacts, Bulk Pack Mating connector shell to Pin 1	Nickel Finish	AC3MBH3-AU-PRE
		25.3 [.996"] 19.5 [.768"] 19.8 [.780"] 12.5 [.492"] 2.7 [.106"] 3.5 [.139"]	XLR 3 pole male, Horizontal PCB, Non-Latching Type, Gold Plated Contacts, Bulk Pack No Ground Link	Nickel Finish	AC3MBHL-AU-PRE
		25.3 [.996"] 24.0 [.945"] 19.5 [.768"] 12.5 [.492"] 2.7 [.106"] 3.5 [.138"]	XLR 3 pole male, Vertical PCB, Gold Plated Contacts, Bulk Pack No Ground Link	Nickel Finish	AC3MBV-AU-PRE

# XLR Connectors











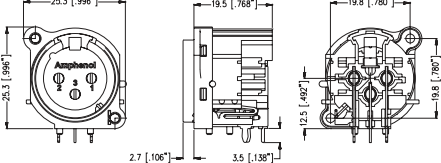

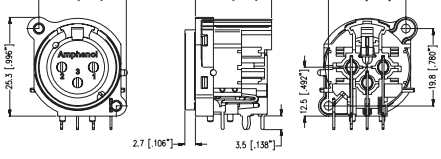

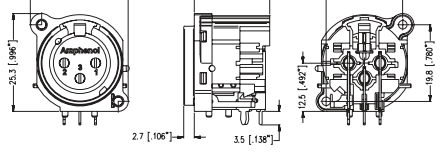
## AC Series XLR PCB Chassis Mount Connectors

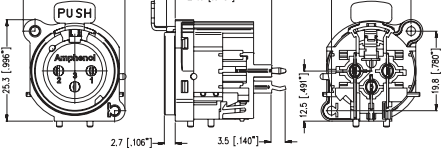
PRODUCT - FIGURE	DRAWING	Dimensions in mm (inches)	DESCRIPTION/ GROUND LINK	MOUNTING FLANGE VARIATIONS	PART NUMBER
			XLR 3 pole male, Vertical PCB, Gold Plated Contacts, Bulk Pack  Pin 1 to Chassis to Mating connector shell	Nickel Finish	AC3MBV1-AU-PRE
			XLR 3 pole male, Vertical PCB, Gold Plated Contacts, Bulk Pack  Mating connector shell to Chassis - Pin 1 sep. Ground	Nickel Finish	AC3MBV2-AU-PRE
			XLR 3 pole male, Vertical PCB, Gold Plated Contacts, Bulk Pack  Mating connector shell to Pin 1	Nickel Finish	AC3MBV3-AU-PRE
			XLR 3 pole female, Horizontal PCB, Latching Type, Gold Plated Contacts, Bulk Pack  No Ground Link	Nickel Finish	AC3FBH-AU-PRE
			XLR 3 pole female, Horizontal PCB, Latching Type, Gold Plated Contacts, Bulk Pack  Pin 1 to Chassis to Mating connector shell	Nickel Finish	AC3FBH1-AU-PRE
			XLR 3 pole female, Horizontal PCB, Latching Type, Gold Plated Contacts, Bulk Pack  Mating connector shell to Chassis - Pin 1 sep. Ground	Nickel Finish	AC3FBH2-AU-PRE
			XLR 3 pole female, Horizontal PCB, Latching Type, Gold Plated Contacts, Bulk Pack  Pin 1 to Chassis	Nickel Finish	AC3FBH3-AU-PRE
			XLR 3 pole female, Horizontal PCB, Non-Latching Type Gold Plated Contacts, Bulk Pack  No Ground Link	Nickel Finish	AC3FBHL-AU-PRE

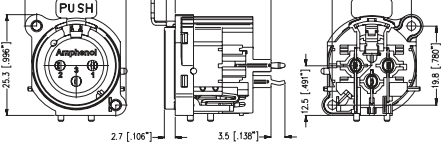

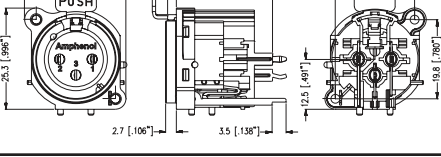

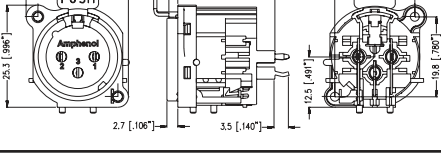

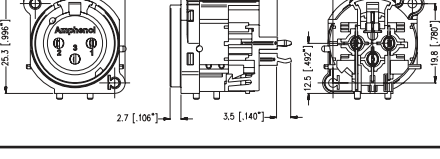





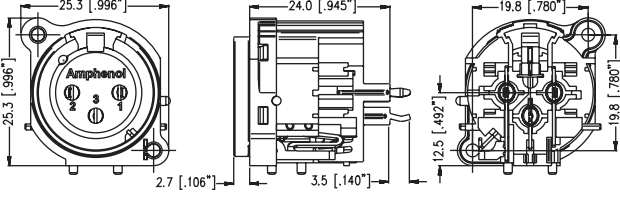

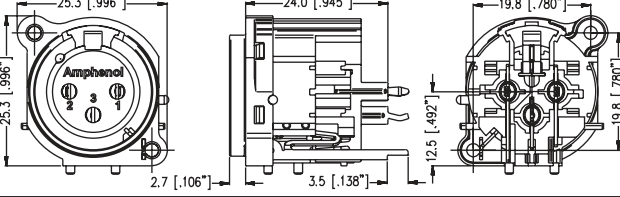
# XLR Connectors

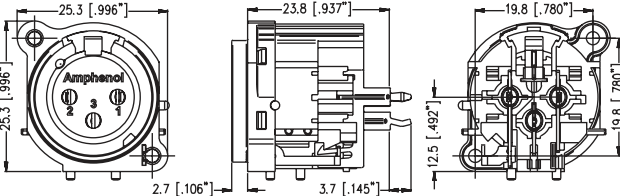
## AC Series XLR PCB Chassis Mount Connectors

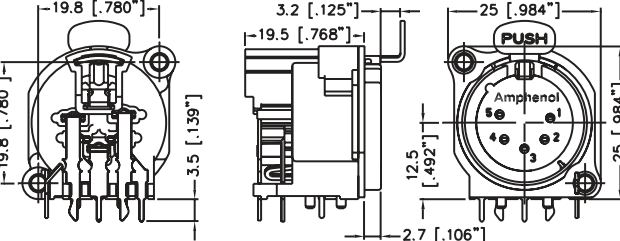
PRODUCT	DRAWING Dimensions in mm (inches)	DESCRIPTION/ GROUND LINK	FINISH	PART NUMBER
		XLR 3 pole female, Horizontal PCB, Non-Latching Type Gold Plated Contacts, Bulk Pack  Pin 1 to Chassis to mating connector shell	Nickel Finish	AC3FBHL1-AU-PRE
		XLR 3 pole female, Horizontal PCB, Non- Latching Type, Gold Plated Contacts, Bulk Pack  Mating connector shell to Chassis - Pin 1 sep. Ground.	Nickel Finish	AC3FBHL2-AU-PRE
		XLR 3 pole female, Horizontal PCB, Non-Latching Type Gold Plated Contacts, Bulk Pack  Pin 1 to Chassis	Nickel Finish	AC3FBHL3-AU-PRE
		XLR 3 pole female, Vertical PCB, Latching Type, Gold Plated Contacts, Bulk Pack  No Ground Link	Nickel Finish	AC3FBV-AU-PRE
		XLR 3 pole female, Vertical PCB, Latching Type, Gold Plated Contacts, Bulk Pack  Pin 1 to Chassis to mating connector shell	Nickel Finish	AC3FBV1-AU-PRE
		XLR 3 pole female, Vertical PCB, Latching Type, Gold Plated Contacts, Bulk Pack  Mating connector shell to Chassis - Pin 1 sep. Ground.	Nickel Finish	AC3FBV2-AU-PRE
		XLR 3 pole female, Vertical PCB, Latching Type, Gold Plated Contacts, Bulk Pack  Pin 1 to Chassis	Nickel Finish	AC3FBV3-AU-PRE
		XLR 3 pole female, Vertical PCB, Non-Latching Type, Gold Plated Contacts, Bulk Pack  No Ground Link	Nickel Finish	AC3FBVL-AU-PRE

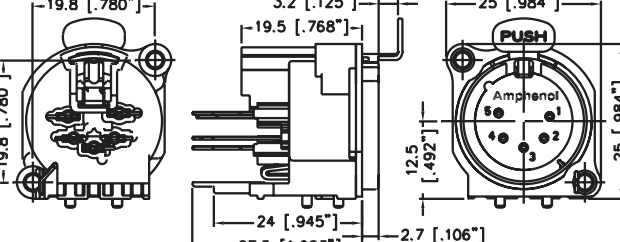
# XLR Connectors

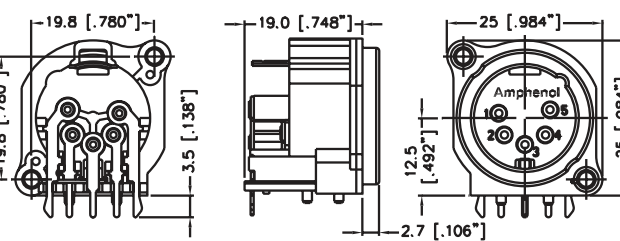
## AC Series XLR PCB Chassis Mount Connectors

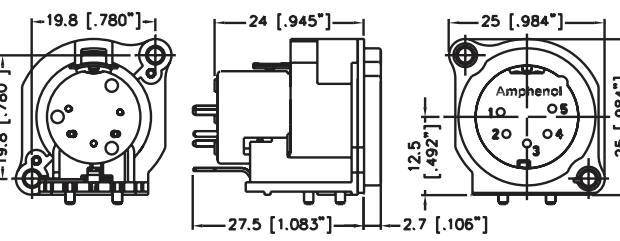
PRODUCT	DRAWING Dimensions in mm (inches)	DESCRIPTION/ GROUND LINK	FINISH	PART NUMBER
		XLR 3 pole female, Vertical PCB, Non-Latching Type, Gold Plated Contacts, Bulk Pack  Pin 1 to Chassis to Mating connector shell	Nickel Finish	AC3FBVL1-AU-PRE
		XLR 3 pole female, Vertical PCB, Non-Latching Type, Gold Plated Contacts, Bulk Pack  Mating connector shell to Chassis-Pin 1 sep. Ground.	Nickel Finish	AC3FBVL2-AU-PRE
		XLR 3 pole female, Vertical PCB, Non-Latching Type, Gold Plated Contacts, Bulk Pack  Pin 1 to Chassis	Nickel Finish	AC3FBVL3-AU-PRE
		XLR 5 pole female, Horizontal PCB, Latching Type, Gold Plated Contacts, Bulk Pack	Nickel Finish	AC5FBH-AU-PRE
		XLR 5 pole female, Vertical PCB, Latching Type, Gold Plated Contacts, Bulk Pack	Nickel Finish	AC5FBV-AU-PRE
		XLR 5 pole male, Horizontal PCB, Gold Plated Contacts, Bulk Pack	Nickel Finish	AC5MBH-AU-PRE
		XLR 5 pole male, Vertical PCB, Gold Plated Contacts, Bulk Pack	Nickel Finish	AC5MBV-AU-PRE

# XLR Connectors

AC Series XLR PCB Chassis Mount Connectors

## PART NUMBER BREAKDOWN

AC SERIES A AND B TYPE MALE - 3 CONTACT

E. G. **AC3MAVL3-AU PRE**  
**AC** (series prefix), **3** contacts, **M**ale, **A** Type, **V**ertical Printed Circuit Board, **L**atchless, **3** (Mating Shell to Pin 1 Grounding), - **AU** (Gold Plated Contacts), **PRE** Bulk Packaged.

<b>SERIES PREFIX</b>	AC = Series Prefix
<b>CONTACT LAYOUT</b>	3 = 3 Contact only
<b>GENDER</b>	M = Male Socket Contacts
<b>SHELL SERIES</b>	A = A Type B = B Type
<b>TERMINATION</b>	H = Horizontal Printed Circuit Board V = Vertical Printed Circuit Board Blank = Solder Bucket Contacts
<b>MOUNTING FLANGE FINISH (B TYPE ONLY)</b>	Blank = Nickel
<b>LOCKING MECHANISM</b>	Blank = Latching L = Latchless
<b>GROUNDING LINK OPTIONS</b>	Blank = No Ground Link 1 = Pin 1 to Chassis to mating connector shell 2 = Mating Connector shell to Chassis, Pin 1 to separate ground 3 = Mating connector to Pin 1 4 = Mating connector to Shell to Chassis to PCB, Pin 1 separate ground
<b>CONTACT PLATING</b>	AU = Gold Plated Contacts AG = Silver Plated Contacts (Non-Standard)
<b>PACKAGING</b>	PRE = Bulk Packed PRD = Disassembled push latch

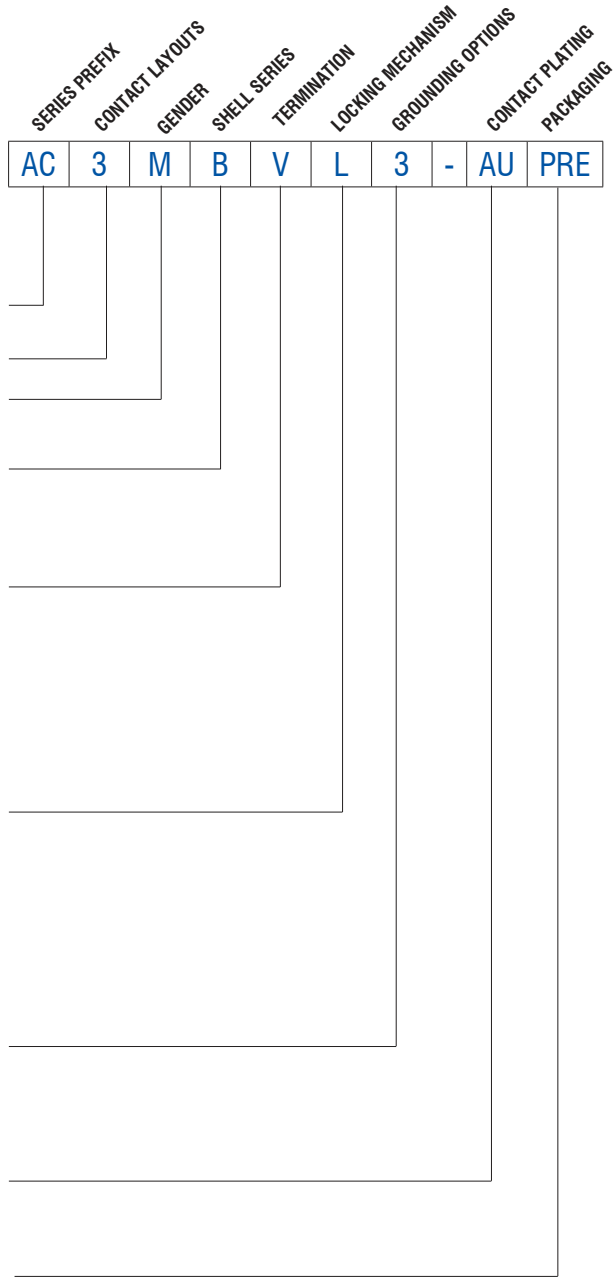

# PART NUMBER BREAKDOWN

## AC SERIES A AND B TYPE FEMALE - 3 CONTACT

E. G. **AC3MAVL3-AU B**  
**AC** (series prefix), **3** contacts, **F**emale, **A** Type, **V**ertical Printed Circuit Board, **L**atchless, **3** (Pin 1 to Chassis Grounding), **- AU** (Gold Plated Contacts), **PRE** Bulk Packaged.

<b>SERIES PREFIX</b>	AC = Series Prefix
<b>CONTACT LAYOUT</b>	3 = 3 Contact only
<b>GENDER</b>	F = Female Socket Contacts
<b>SHELL SERIES</b>	A = A Type B = B Type
<b>TERMINATION</b>	H = Horizontal Printed Circuit Board V = Vertical Printed Circuit Board
<b>LOCKING MECHANISM</b>	Blank = Latching L = Latchless
<b>GROUNDING LINK OPTIONS</b>	Blank = No Ground Link 1 = Pin 1 to Chassis to mating connector shell 2 = Mating Connector shell to Chassis, Pin 1 to separate ground 3 = Pin 1 to Chassis
<b>CONTACT PLATING</b>	AU = Gold Plated Contacts AG = Silver Plated Contacts (Non-Standard)
<b>PACKAGING</b>	PRE = Bulk Packed PRD = Disassembled push latch

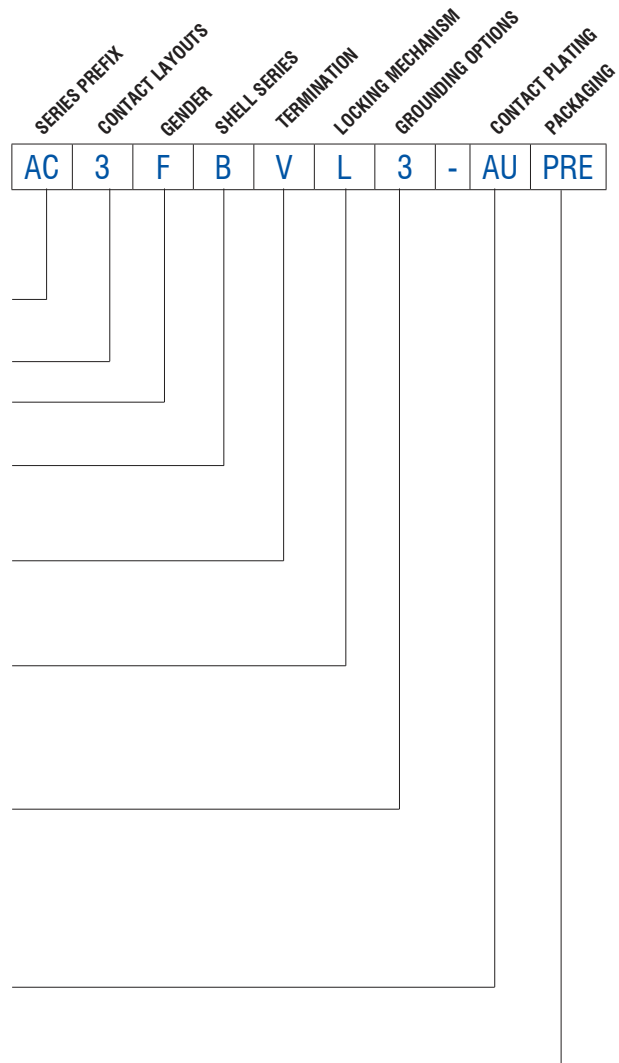

# XLR Connectors

AC Series XLR PCB Chassis Mount Connectors

## PART NUMBER BREAKDOWN



AC SERIES A AND B TYPE MALE AND FEMALE - 4 / 5 CONTACT

E. G. **AC5FAV-AU-B**  
**AC** (series prefix), **5** contacts, **F**emale, **A** Type, **V**ertical Printed Circuit Board, **AU**  
 (Gold Plated Contacts) - **B**ulk Packaged.

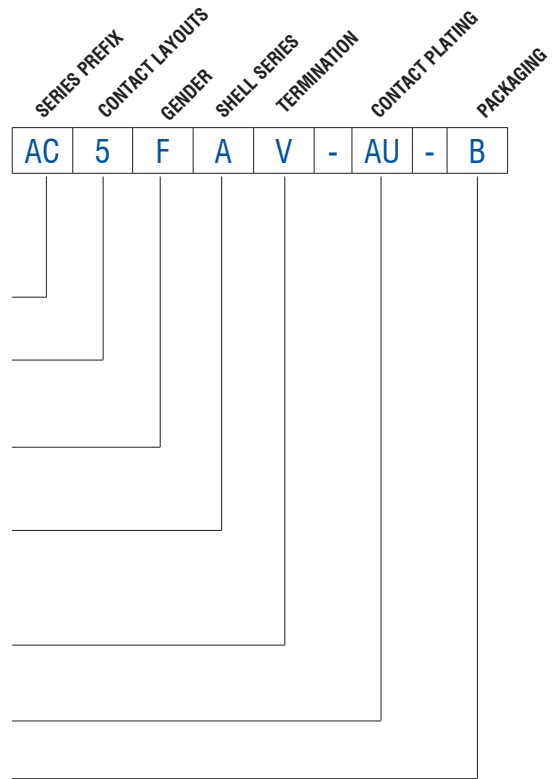
<b>SERIES PREFIX</b>	AC = Series Prefix
<b>CONTACT LAYOUT</b>	4 = 4 Contact 5 = 5 Contact
<b>GENDER</b>	F = Female Socket Contacts M = Male Pin Contacts
<b>SHELL SERIES</b>	A = A Type B = B Type
<b>TERMINATION</b>	H = Horizontal Printed Circuit Board V = Vertical Printed Circuit Board
<b>CONTACT PLATING</b>	AU = Gold Plated Contacts
<b>PACKAGING</b>	B = Bulk Packed PRE = PRE Series Bulk Packed



### STANDARD DATA AC SERIES A AND B TYPE CHASSIS

		VALUE		
<b>GENERAL CHARACTERISTICS</b>	Number of contacts	3	4	5
	Contact Arrangements (Front view of pin insert)			
	Termination	Printed Circuit Board (PCB)		
	Flammability rating of plastics	UL94V-0		
	Environmental	Complies with EU RoHS 2 Directive 2011/65/EU		
<b>ELECTRICAL CHARACTERISTICS</b>	Service Voltage RMS	133V <sup>1</sup>		
	Test Voltage AC RMS	1500V		
	Current carrying capacity	6A		3A
	Typical Contact Resistance	≤5mΩ		
	Insulation Resistance (initial)	≥2GΩ		
	Insulation Resistance (after damp heat test)	≥1GΩ		
<b>CLIMATIC CHARACTERISTICS</b>	Protection Class	IP40		
	Operating Temperature	-25 °C to +75 °C (-13°F to +167°F)		
<b>MECHANICAL CHARACTERISTICS</b>	Weight <sup>2</sup>	14g (0.030lb)		
	Retention Spring separating force	≥20N		
	Mounting Screw torque max.	1.5Nm		
	Mechanical Operations	1500 mating cycles		
	Fastening A Type Connectors <sup>3</sup>	Self-Tapping PT screw with thread 2.9 x 1.06 and of Tri-rondular configuration		
	Fastening B Type Connectors <sup>3</sup>	Self-Tapping screw M2.5		
<b>MATERIALS</b>	Connector Flange - B-Type	Diecast Zinc Alloy		
	Flange Finish - B-Type	Nickel		
	Insulators	PA6.6+25% glass fibre reinforced, UL94V-0		
	Male Contact Material	Brass		
	Male Contact Plating	0.05μm gold over 2μm nickel		
	Female Contact Material	Bronze		
	Female Contact Plating	0.05μm gold over 2μm nickel		
	Latch lock and Spring	Spring Steel		
	Ground element	Spring Steel		

<sup>1</sup> Not suitable for domestic applications above 50V

<sup>2</sup> Approximate weight only, does not include packaging. Please contact us for exact weight for shipping purposes.

<sup>3</sup> Refer to page 134

### AC SERIES A AND B TYPE CHASSIS PCB FOOTPRINTS - CONNECTOR SIDE OF PCB

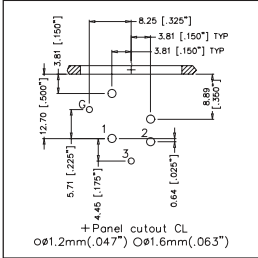

**AC3FAH2  
AC3FBH2**

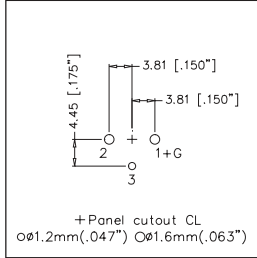

**AC3FAV1  
AC3FAV3  
AC3FBV1  
AC3FBV3  
AC3FAV  
AC3FBV**

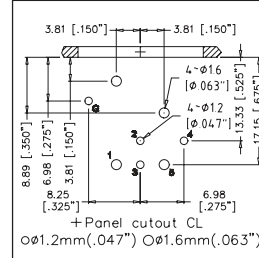

**AC5FAH**

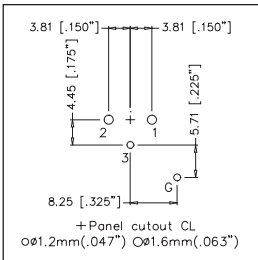

**AC3FAV2  
AC3FBV2**

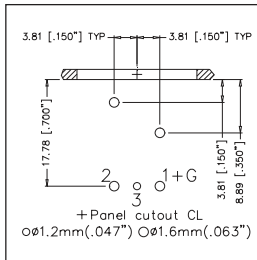

**AC3MAH1  
AC3MAH3  
AC3MBH1  
AC3MBH3  
AC3MAH  
AC3MBH  
AC3MBHL**

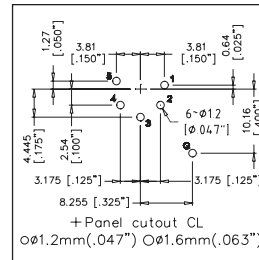

**AC5FAV**

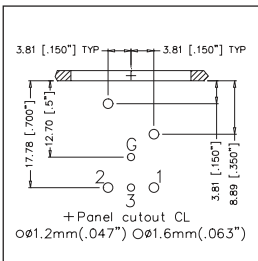

**AC3MAH2  
AC3MAH4  
AC3MBH2**

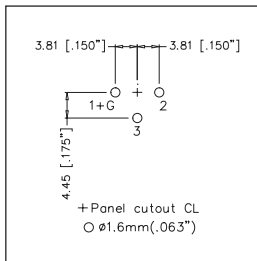

**AC3MAV1  
AC3MAV3  
AC3MBV1  
AC3MBV3  
AC3MAV  
AC3MBV**

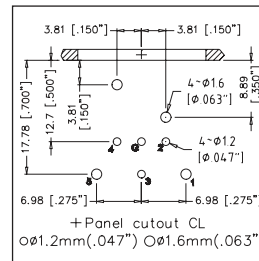

**AC5MAH**

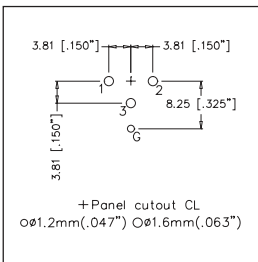

**AC3MAV2  
AC3MAV4  
AC3MBV2**

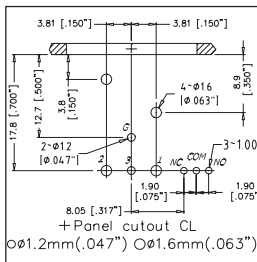

**AC3MAH4SWB**

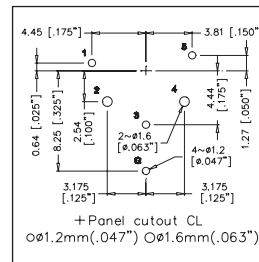

**AC5MAV**

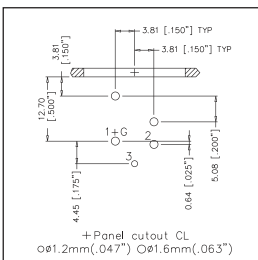

**AC3FAH1  
AC3FAH3  
AC3FBH1  
AC3FBH3  
AC3FAH  
AC3FBH**

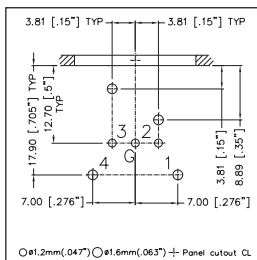

**AC4MAH**

# AC SERIES A AND B TYPE CHASSIS PANEL CUTOUT DIMENSIONS - FRONT VIEW

**A TYPE**

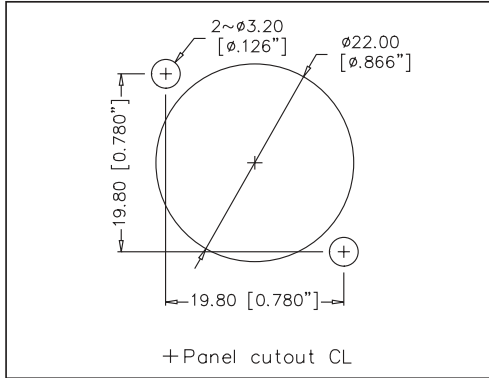

**B TYPE**

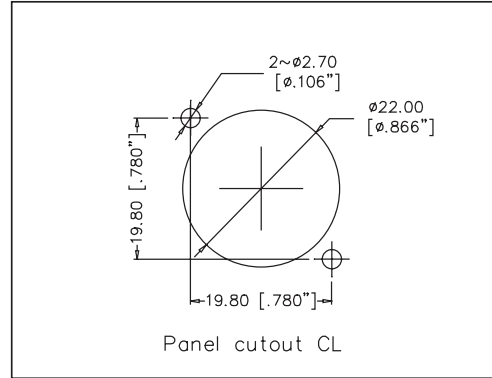

**A AND B  
TYPE MALE  
MOUNTING  
PITCH**

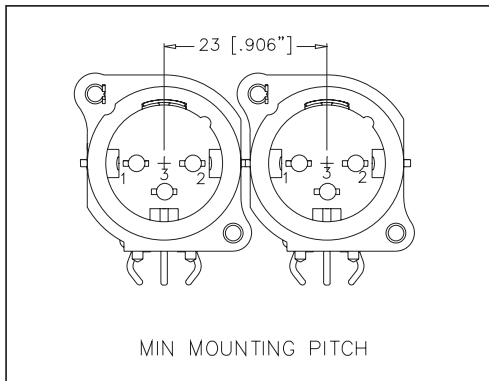

**A AND  
B TYPE  
FEMALE  
MOUNTING  
PITCH**

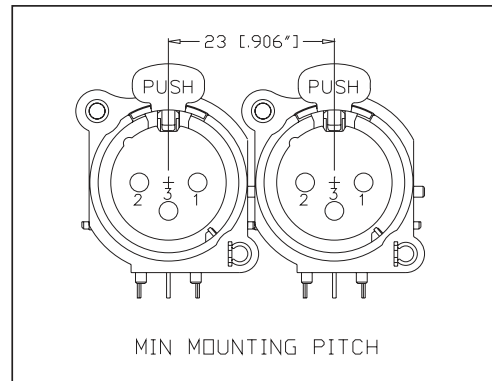

## AC3FA/BH/V SCHEMATIC CHART

AC3FA/BH/V3-AU  
AC3FA/BH/VL3-AU

AC3FA/BH/V2-AU  
AC3FA/BH/VL2-AU

AC3FA/BH/V1-AU  
AC3FA/BH/VL1-AU

AC3FA/BH/V-AU  
AC3FA/BH/VL-AU

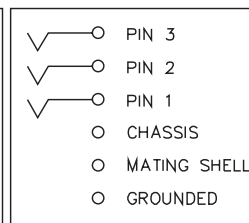
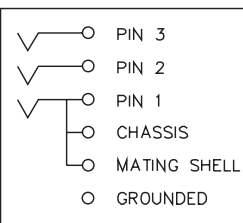
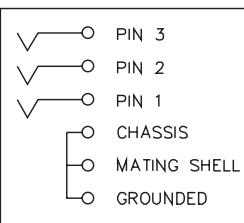
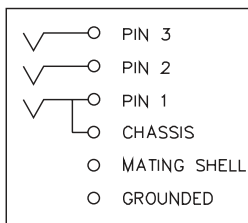

AC3MA/BH/V3-AU  
AC3MA/BH/VL3-AU

AC3MA/BH/V2/4-AU  
AC3MA/BH/VL2/4-AU

AC3MA/BH/V1-AU  
AC3MA/BH/VL1-AU

AC3MA/BH/V-AU  
AC3MA/BH/VL-AU

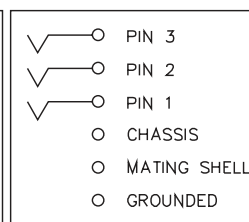
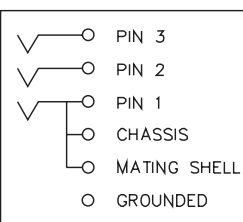
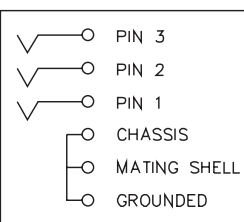
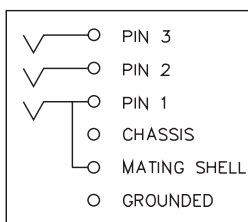



# XLR Connectors

AC Series Dual 1/4" (6.35mm) / XLR Chassis Mount



## AC SERIES DUAL 1/4" (6.35MM) / XLR CHASSIS MOUNT

The AC Series C type chassis receptacles feature two connectors in the one space saving housing. A combined XLR female receptacle together with a 6.35mm (1/4") phone jack give the designer more flexibility ensuring premium board space is saved. The new low profile high density C type offers a 15% space saving over the traditional C type. Various configurations are available in either stereo or mono layouts with Vertical, Horizontal Printed Circuit Board or Solder contacts.

### Ordering Codes

We have listed the more common ordering codes in each section. For further options please refer to the part number breakdown charts. Please contact us if you need any further assistance.

### Simple steps to guide you in using this catalogue

- 1) Identify the product group listed in Contents on page 1 and go directly to that page number.
- 2) Each product group cover page then details information and options available.
- 3) Refer to the product detail pages and identify the product you require pictorially.
- 4) Read the product description column for the products standard features.
- 5) Use variations column to determine your choice.
- 6) Identify part number.
- 7) In the event the particular option you require is not listed please refer to the part number breakdown page at the end of each section.
- 8) Please contact us directly if you have any further problems.

### Features

- Standard or low profile / high density shell design
- Two connectors in the one housing.
- Industry standard PCB footprint layout on standard C type.
- Vertical or Horizontal PCB mounting.
- Bulk packed.
- Positive latch lock system (XLR).

### Options

- Solder contacts
- Vertical PCB contacts
- Horizontal PCB contacts
- Bulk Packaging
- Overmoldable connector housing

# XLR Connectors

## AC Series Dual 1/4" (6.35mm) / XLR Chassis Mount



### Features:

- Two connectors in the one housing.
- Low profile design offers a 15% space saving over the traditional design.
- Vertical or Horizontal PCB mounting.
- Bulk packed in trays, 100 to a box as standard.
- Positive latch lock system (XLR).

**Part Number Breakdown:** [Page 48](#)

**Specifications:** [Page 50](#)









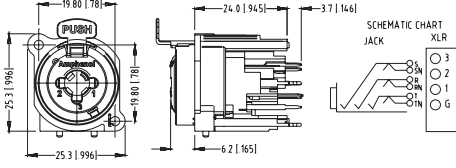

**PCB Footprints:** [Page 49](#)

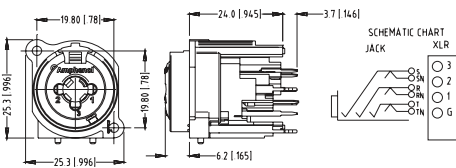
**Recommended Fastener:** [Page 134](#)

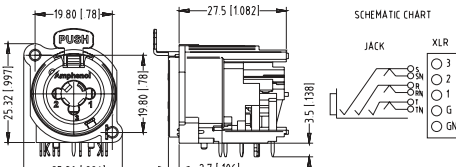
PRODUCT - FIGURE	DRAWING	Dimensions in mm (inches)	DESCRIPTION	VARIATIONS	PART NUMBER
		19.80 [.781] 27.5 [1.082] 25.30 [996] 19.80 [.781] 25.30 [996] 2.7 [106] 3.5 [138]	Low Profile XLR 3 pole female receptacle with 1/4" stereo jack without switching contact, Horizontal PCB mount, Bulk Pack	Latching	ACJC6AH BULK
		19.80 [.781] 27.5 [1.082] 25.30 [996] 19.80 [.781] 25.30 [996] 2.7 [106] 3.5 [138]	Low Profile XLR 3 pole female receptacle with 1/4" stereo jack without switching contact, Horizontal PCB mount, Bulk Pack	Non-latching, Retention Spring	ACJC6AHL BULK
		19.80 [.781] 24.0 [.945] 25.3 [996] 19.80 [.781] 25.3 [996] 6.2 [165] 3.7 [146]	Low Profile XLR 3 pole female receptacle with 1/4" stereo jack without switching contact, Vertical PCB mount, Bulk Pack	Latching	ACJC6AV2 BULK
		19.80 [.781] 24.0 [.945] 25.3 [996] 19.80 [.781] 25.3 [996] 6.2 [165] 3.7 [146]	Low Profile XLR 3 pole female receptacle with 1/4" stereo jack without switching contact, Vertical PCB mount, Bulk Pack	Non-latching, Retention Spring	ACJC6AV2L BULK
		19.80 [.781] 27.5 [1.082] 25.30 [996] 19.80 [.781] 25.30 [996] 2.7 [106] 3.50 [138]	Low Profile XLR 3 pole female receptacle with 1/4" switching stereo jack, Horizontal PCB mount, Bulk Pack	Latching	ACJC9AH BULK
		19.80 [.781] 27.5 [1.082] 25.30 [996] 19.80 [.781] 25.30 [996] 2.7 [106] 3.50 [138]	Low Profile XLR 3 pole female receptacle with 1/4" switching stereo jack, Horizontal PCB mount, Bulk Pack	Non-latching, Retention Spring	ACJC9AHL BULK

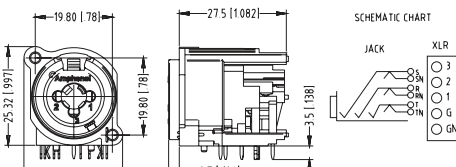
# XLR Connectors

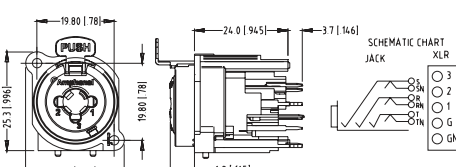
## AC Series Dual 1/4" (6.35mm) / XLR Chassis Mount

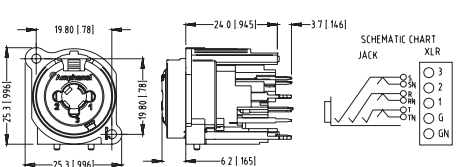
PRODUCT - FIGURE	DRAWING	Dimensions in mm (inches)	DESCRIPTION	VARIATIONS	PART NUMBER
			Low Profile XLR 3 pole female receptacle with 1/4" switching stereo jack, Vertical PCB mount, Bulk Pack	Latching	<a href="#">ACJC9AV2 BULK</a>
			Low Profile XLR 3 pole female receptacle with 1/4" switching stereo jack, Vertical PCB mount, Bulk Pack	Non-latching, Retention Spring	<a href="#">ACJC9AV2L BULK</a>
			Low Profile XLR 3 pole female receptacle with 1/4" switching stereo jack and switching ground contact, Horizontal PCB mount, Bulk Pack	Latching	<a href="#">ACJC10AH BULK</a>
			Low Profile XLR 3 pole female receptacle with 1/4" switching stereo jack and switching ground contact, Horizontal PCB mount, Bulk Pack	Non-latching, Retention Spring	<a href="#">ACJC10AHL BULK</a>
			Low Profile XLR 3 pole female receptacle with 1/4" switching stereo jack and switching ground contact, Vertical PCB mount, Bulk Pack	Latching	<a href="#">ACJC10AV2 BULK</a>
			Low Profile XLR 3 pole female receptacle with 1/4" switching stereo jack and switching ground contact, Vertical PCB mount, Bulk Pack	Non-latching, Retention Spring	<a href="#">ACJC10AV2L BULK</a>

# XLR Connectors

## AC Series Dual 1/4" (6.35mm) / XLR Chassis Mount



### Features:

- Two connectors in the one housing.
- Space saving design.
- Industry standard PCB footprint layout.
- Vertical or Horizontal PCB mounting.
- Bulk packed in trays, 100 to a box as standard.
- Positive latch lock system (XLR).

**Part Number Breakdown:** Page 48

**Specifications:** Page 50











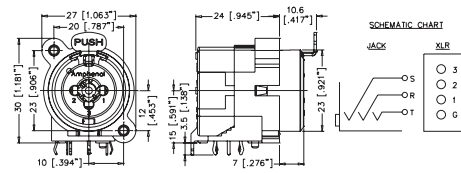

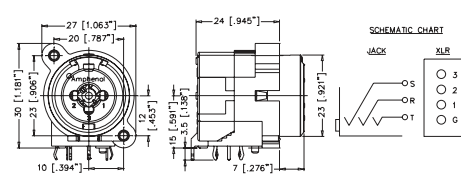

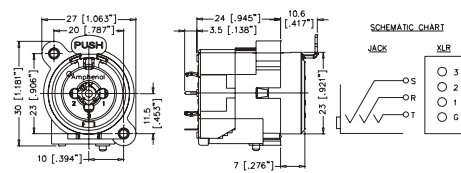
**PCB Footprints:** Page 49

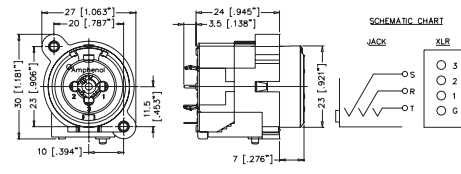
**Recommended Fastener:** Page 134

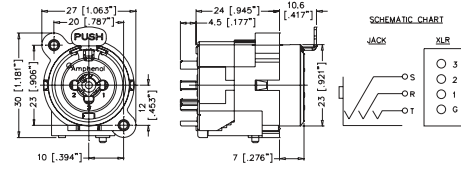
PRODUCT - FIGURE	DRAWING	Dimensions in mm (inches)	DESCRIPTION	VARIATIONS	PART NUMBER
			XLR 3 pole female receptacle with 1/4" mono jack without switching contact, Horizontal PCB mount, Bulk Pack	Latching	ACJC5H BULK
			XLR 3 pole female receptacle with 1/4" mono jack without switching contact, Horizontal PCB mount, Bulk Pack	Non-latching, Retention Spring	ACJC5HL BULK
			XLR 3 pole female receptacle with 1/4" mono jack without switching contact, Vertical PCB mount, Bulk Pack	Latching	ACJC5V BULK
			XLR 3 pole female receptacle with 1/4" mono jack without switching contact, Vertical PCB mount, Bulk Pack	Non-latching, Retention Spring	ACJC5VL BULK
			XLR 3 pole female receptacle with 1/4" mono jack without switching contact, Solder Contacts, Bulk Pack	Latching	ACJC5S BULK
			XLR 3 pole female receptacle with 1/4" mono jack without switching contact, Solder Contacts, Bulk Pack	Non-latching, Retention Spring	ACJC5SL BULK

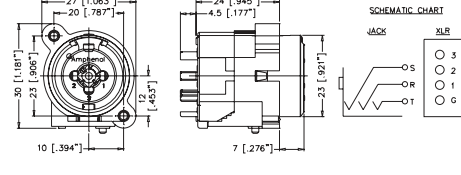

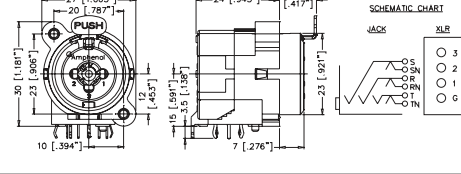

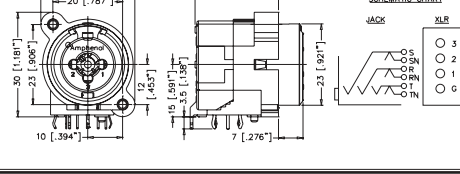





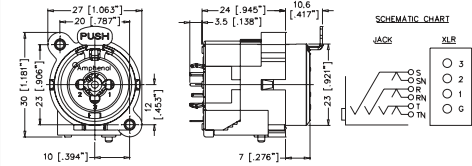

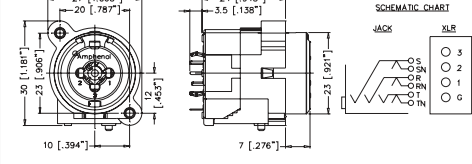

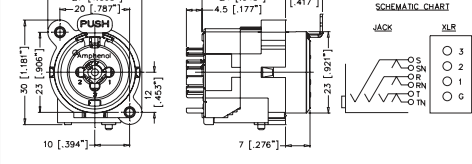
# XLR Connectors

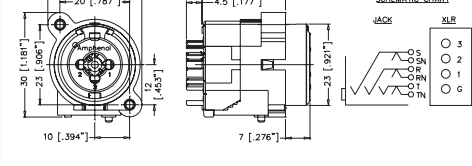
## AC Series Dual 1/4" (6.35mm) / XLR Chassis Mount

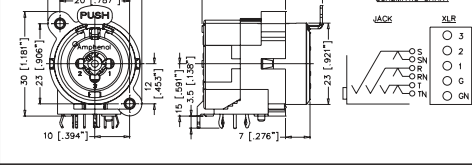
PRODUCT - FIGURE	DRAWING	DESCRIPTION	VARIATIONS	PART NUMBER
		XLR 3 pole female receptacle with 1/4" stereo jack without switching contact, Horizontal PCB mount, Bulk Pack	Latching	ACJC6H BULK
		XLR 3 pole female receptacle with 1/4" stereo jack without switching contact, Horizontal PCB mount, Bulk Pack	Non-latching, Retention Spring	ACJC6HL BULK
		XLR 3 pole female receptacle with 1/4" stereo jack without switching contact, Vertical PCB mount, Bulk Pack	Latching	ACJC6V BULK
		XLR 3 pole female receptacle with 1/4" stereo jack without switching contact, Vertical PCB mount, Bulk Pack	Non-latching, Retention Spring	ACJC6VL BULK
		XLR 3 pole female receptacle with 1/4" stereo jack without switching contact, Solder Contacts, Bulk Pack	Latching	ACJC6S BULK
		XLR 3 pole female receptacle with 1/4" stereo jack without switching contact, Solder Contacts, Bulk Pack	Non-latching, Retention Spring	ACJC6SL BULK
		XLR 3 pole female receptacle with 1/4" switching stereo jack, Horizontal PCB mount, Bulk Pack	Latching	ACJC9H BULK
		XLR 3 pole female receptacle with 1/4" switching stereo jack, Horizontal PCB mount, Bulk Pack	Non-latching, Retention Spring	ACJC9HL BULK

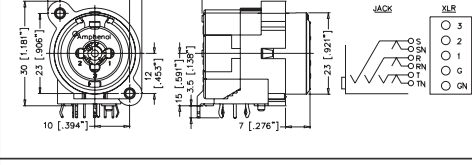

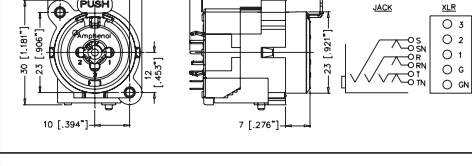
# XLR Connectors

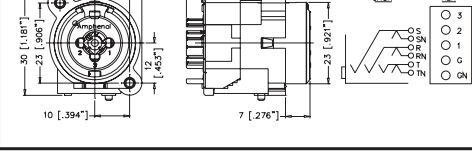
## AC Series Dual 1/4" (6.35mm) / XLR Chassis Mount

PRODUCT - FIGURE	DRAWING	DESCRIPTION	VARIATIONS	PART NUMBER
		XLR 3 pole female receptacle with 1/4" switching stereo jack, Vertical PCB mount, Bulk Pack	Latching	ACJC9V BULK
		XLR 3 pole female receptacle with 1/4" switching stereo jack, Vertical PCB mount, Bulk Pack	Non-latching, Retention Spring	ACJC9VL BULK
		XLR 3 pole female receptacle with 1/4" switching stereo jack, Solder Contacts, Bulk Pack	Latching	ACJC9S BULK
		XLR 3 pole female receptacle with 1/4" switching stereo jack, Solder Contacts, Bulk Pack	Non-latching, Retention Spring	ACJC9SL BULK
		XLR 3 pole female receptacle with 1/4" switching stereo jack and switching ground contact, Horizontal PCB mount, Bulk Pack	Latching	ACJC10H BULK
		XLR 3 pole female receptacle with 1/4" switching stereo jack and switching ground contact, Horizontal PCB mount, Bulk Pack	Non-latching, Retention Spring	ACJC10HL BULK
		XLR 3 pole female receptacle with 1/4" switching stereo jack and switching ground contact, Vertical PCB mount, Bulk Pack	Latching	ACJC10V BULK
		XLR 3 pole female receptacle with 1/4" switching stereo jack and switching ground contact, Vertical PCB mount, Bulk Pack	Non-latching, Retention Spring	ACJC10VL BULK

# XLR Connectors

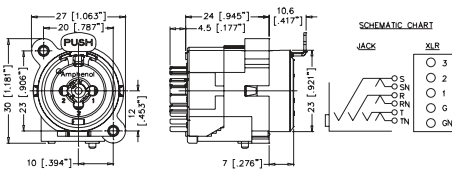
AC Series Dual 1/4" (6.35mm) / XLR Chassis Mount

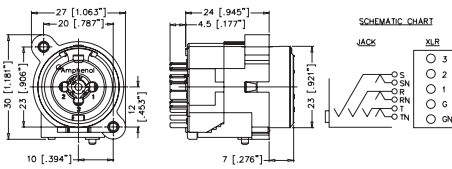
PRODUCT - FIGURE	DRAWING	DESCRIPTION	VARIATIONS	PART NUMBER
		XLR 3 pole female receptacle with 1/4" switching stereo jack and switching ground contact, Solder Contacts, Bulk Pack	Latching	ACJC10S BULK
		XLR 3 pole female receptacle with 1/4" switching stereo jack and switching ground contact, Solder Contacts, Bulk Pack	Non-latching, Retention Spring	ACJC10SL BULK

## PART NUMBER BREAKDOWN

### AC SERIES THERMOPLASTIC C TYPE

E. G. **ACJC5HL BULK**  
**AC** (Series Prefix), **JC** Jack/Connector XLR, **5** Mono, **H**orizontal Printed Circuit Board, **L**atchless, **BULK** Packaged.

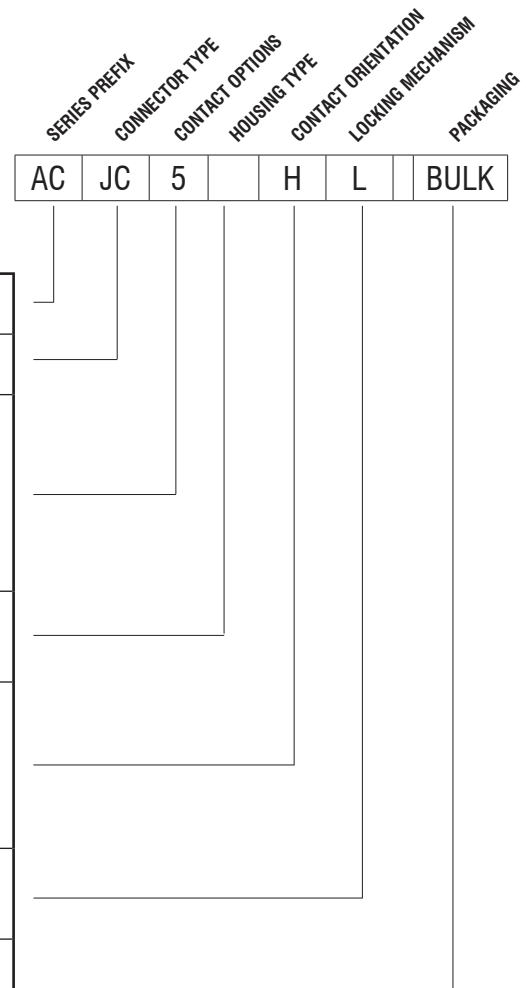

<b>SERIES PREFIX</b>	AC = Series Prefix
<b>CONNECTOR TYPE</b>	JC = Jack / Connector XLR
<b>CONTACT OPTIONS</b>	5 = Mono, Non Switching, XLR Grounded 6 = Stereo, Non Switching, XLR Grounded 9 = Stereo, Switching, XLR Grounded 10 = Stereo, Switching, XLR with Ground Switch
<b>HOUSING TYPE</b>	Blank = Standard A = Low Profile / High Density
<b>CONTACT TYPE</b>	V = Vertical Printed Circuit Board V2 = Vertical Printed Circuit Board (24mm) H = Horizontal Printed Circuit Board S = Solder Contacts
<b>LOCKING MECHANISM</b>	Blank = Latching L = Latchless
<b>PACKAGING</b>	Blank = Individual Bags BULK = Bulk Packed PRD = Disassembled push lever

### AC SERIES C TYPE SERIES

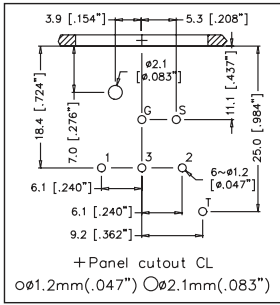

**ACJC5H & ACJC5HL**

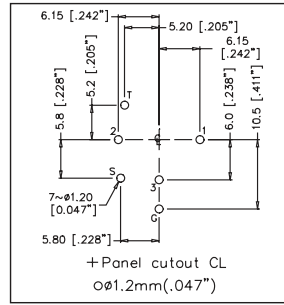

**ACJC5V & ACJC5VL**

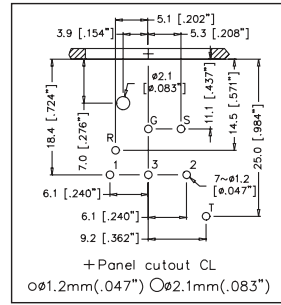

**ACJC6H & ACJC6HL**

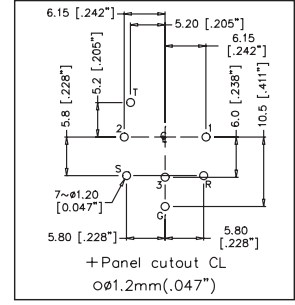

**ACJC6V & ACJC6VL**

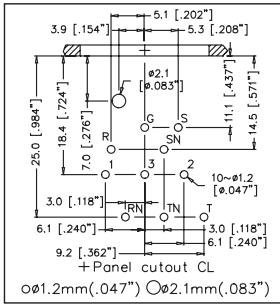

**ACJC9H & ACJC9HL**

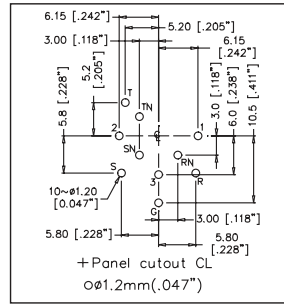

**ACJC9V & ACJC9VL**

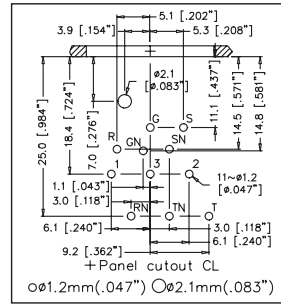

**ACJC10H & ACJC10HL**

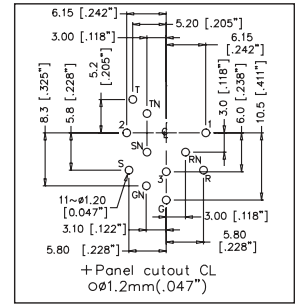

**ACJC10V & ACJC10VL**

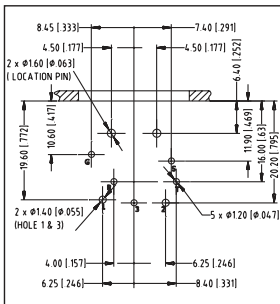

**ACJC6AH & ACJC6AHL**

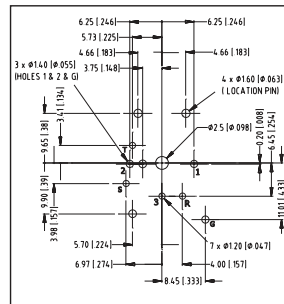

**ACJC6AV2 & ACJC6AV2L**

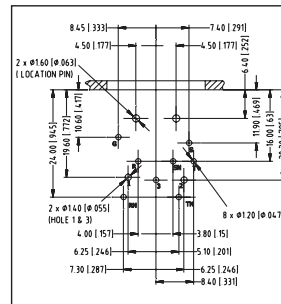

**ACJC9AH & ACJC9AHL**

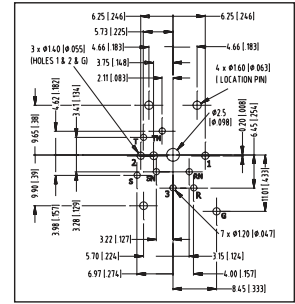

**ACJC9AV2 & ACJC9AV2L**

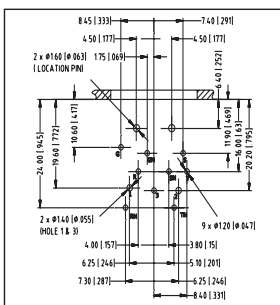

**ACJC10AH & ACJC10AHL**

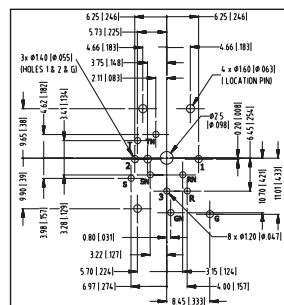

**ACJC10AV2 & ACJC10AV2L**

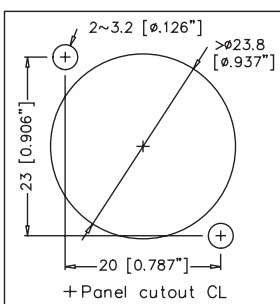

**C TYPE PANEL CUTOUT**

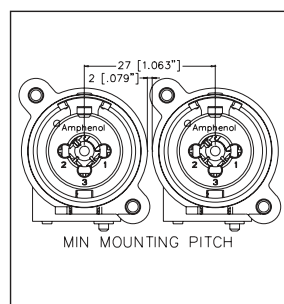

**C TYPE MOUNTING PITCH**

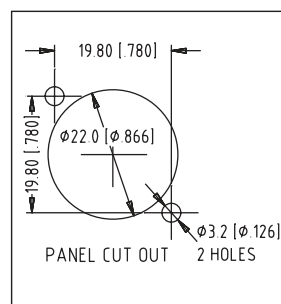

**C TYPE LOW PROFILE PANEL CUTOUT**

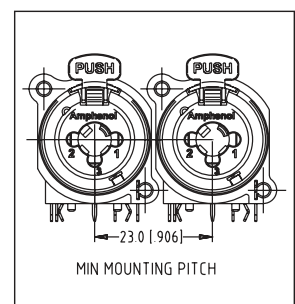

**C TYPE LOW PROFILE MOUNTING PITCH**



# XLR Connectors

AC Series Dual 1/4" (6.35mm) / XLR Chassis Mount

## STANDARD DATA C TYPE CHASSIS RECEPTACLES

		VALUE	
		LOW PROFILE TYPE	STANDARD C TYPE
<b>GENERAL CHARACTERISTICS</b>	Number of contacts	5, 6, 9 or 10	
	Termination	Printed Circuit Board (PCB)	Printed Circuit Board (PCB) or Solder Bucket
	Flammability	UL 94HB	
	Environmental	Complies with EU RoHS 2 Directive 2011/65/EU	
<b>ELECTRICAL CHARACTERISTICS</b>	Service Voltage RMS	50V	
	Test Voltage AC RMS	1500V	
	Current carrying capacity	7.5A	
	Typical Contact Resistance	≤50mΩ	
	Insulation Resistance (initial)	> 0.5GΩ	
	Insulation Resistance (after damp heat test)	> 0.2GΩ	
<b>CLIMATIC CHARACTERISTICS</b>	Protection Class	IP40	
	Operating Temperature	-25 °C to +70 °C	
<b>MECHANICAL CHARACTERISTICS</b>	Weight**	9.2g (0.02lb)	14g (0.030lb)
	Retention Spring separating force	≥20N	
	Mounting Screw torque max.	1.5Nm	
	Mechanical Operations	1500 mating cycles	
	Fastening***	Self-Tapping PT screw with thread 2.9 x 1.06 and of Tri-rondular configuration	
<b>MATERIALS</b>	Connector Shell	PA6.6 + 30% glass fibre reinforced, UL94HB	PA6.6 + 20% glass fibre reinforced, UL94HB
	Shell Finish		Black
	Insulators	PA6.6 glass fibre reinforced, UL94HB	PA6.6 + 20% glass fibre reinforced, UL94HB
	XLR Contact	Bronze	
	Material	Gold over Nickel plated	
	Plating		
	Jack Contact	Bronze	
	Material	Bronze	Brass
Plating	Gold over Nickel plated	Silver over Copper plated	
Latch lock and Spring	Nickel Plated		
Ground element	Nickel Plated	Silver over Copper plated	

\*\*Approximate weight in grams not including packaging. Please contact us for exact weight for shipping purposes.

\*\*\*Refer to Page 134

Rev 6 - 03/2013



# G-TYPE MINIATURE XLR CONNECTORS

### Features:

- Miniature version of the standard XLR series
- Diecast or Precision machined metal housings
- Metal cable clamp
- Precision machined pin contacts
- Stamped socket contacts
- Solder cup or Printed Circuit board contacts
- Available in 3, 4, 5 or 6 contacts
- Postive latchlock
- Flexible cable grommet



**Part Number Breakdown: Page 52**  
**PCB Footprints: Page 54**

**Specifications: Page 53**  
**Panel Cutouts: Page 54**

PRODUCT - FIGURE	DRAWING	DESCRIPTION	VARIATIONS	PART NUMBER
		Male cable connector, Machined contacts, Nickel Finish	3 pole 4 pole 5 pole 6 pole	AG3M AG4M AG5M AG6M
		Female cable connector, Stamped contacts, Nickel Finish	3 pole 4 pole 5 pole 6 pole	AG3F AG4F AG5F AG6F
		Female cable connector with locking ring, Stamped contacts, Nickel Finish.	3 pole 4 pole 5 pole 6 pole	AG3FL AG4FL AG5FL AG6FL
		Male chassis connector, Machined contacts, Nickel Finish	3 pole 4 pole 5 pole 6 pole	AG3MCC AG4MCC AG5MCC AG6MCC
		Female chassis connector, Stamped contacts, Nickel Finish	3 pole 4 pole 5 pole 6 pole	AG3FCE AG4FCE AG5FCE AG6FCE
		Male chassis connector, Horizontal PCB, Machined contacts, Nickel Finish	3 pole 4 pole 5 pole 6 pole	AG3MCCH AG4MCCH AG5MCCH AG6MCCH
		Female chassis connector, Horizontal PCB, Stamped contacts, Nickel Finish	3 pole 4 pole 5 pole 6 pole	AG3FCCH AG4FCCH AG5FCCH AG6FCCH

# XLR Connectors

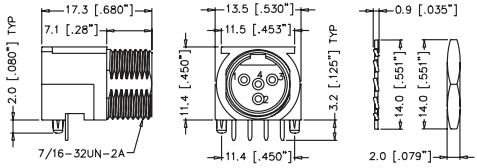
## G-Type Miniature XLR Connectors

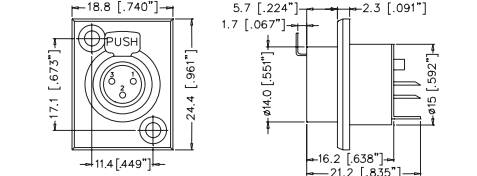
		<p>Male chassis connector, Horizontal PCB, Machined contacts, Thermoplastic shell</p>	<p>4 pole</p>	<p>AG4MPCH</p>
		<p>Female chassis connector, Stamped contacts, Nickel Finish</p>	<p>3 pole</p>	<p>AG3FCRV</p>
			<p>4 pole</p>	<p>AG4FCRV</p>
			<p>5 pole</p>	<p>AG5FCRV</p>
			<p>6 pole</p>	<p>AG6FCRV</p>

# PART NUMBER BREAKDOWN

## G TYPE CONNECTORS

E. G. **AG3MCCHB**  
**AG** (Series Prefix), **3** contacts, **Male**, **Chassis Connector**, **Horizontal PCB Contacts**, **Black finish**.

<b>SERIES PREFIX</b>	AG	=	Series Prefix
<b>CONTACT LAYOUTS</b>	3	=	3 Contacts
	4	=	4 Contacts
	5	=	5 Contacts
	6	=	6 Contacts
<b>GENDER</b>	F	=	Female Socket Contacts
	M	=	Male Pin Contacts
	Blank	=	Cable Connector Standard (Male or Female)
<b>SHELL STYLE</b>	J	=	Cable Connector Large Cable clamp / boot O.D (Male or Female)
	L	=	Cable Connector with locking ring (Female)
	LL	=	Latchless (Chassis Connector)
	CC	=	Chassis Connector Circular Metal (Male)
	CE	=	Rear Mount (Chassis Connector)
	CM	=	Mid Mount (Chassis Connector)
	CR	=	Chassis Connector Rectangular Metal (Female)
	PC	=	Chassis Connector Plastic (Male)
	Blank	=	Solder Buckets (All styles except PC, CR)
<b>CONTACT TYPE</b>	H	=	Horizontal PCB (Style CC, PC only)
	V	=	Vertical PCB (Style CR only)
	Blank	=	Nickel Plated Finish
<b>SHELL FINISH</b>	B	=	Black Finish

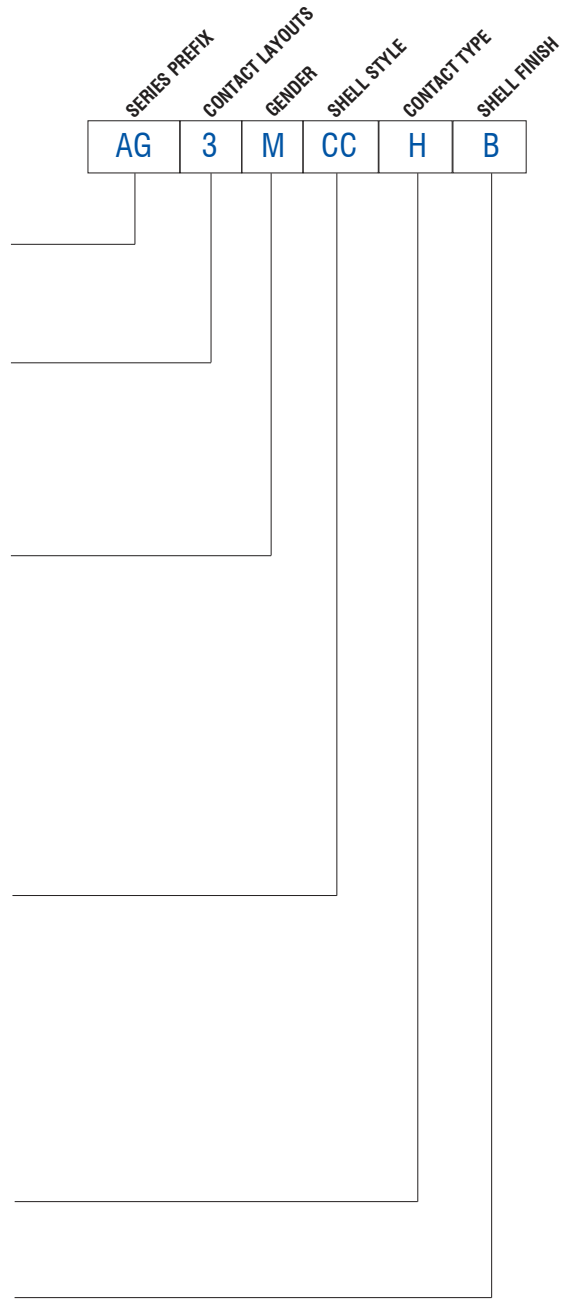

# STANDARD DATA G TYPE

		VALUE			
<b>GENERAL CHARACTERISTICS</b>	Number of Contacts	3	4	5	6
	Termination	Printed Circuit Board (PCB) or Solder Bucket			
	Max. Wire Gauge - Stranded Wire	AWG 24 - 0.5mm <sup>2</sup>			AWG 28 - 0.38mm <sup>2</sup>
	Flammability	UL94V-HB			
	Environmental	Complies with EU RoHS 2 Directive 2011/65/EU			
<b>ELECTRICAL CHARACTERISTICS</b>	Current Carrying Capacity	5A	5A	4A	1.2A
	Typical Contact Resistance	≤10mΩ			
	Insulation resistance (initial) After Damp Heat Test	≥510MΩ ≥10MΩ			
	Dielectric Strength	1000 V dc			250 V dc
<b>CLIMATIC CHARACTERISTICS</b>	Protection Class	IP00			
	Operating Temperature	-30 °C to +80 °C (-20F - +176F)			
<b>MECHANICAL CHARACTERISTICS</b>	Insertion Spring Separating Force	≥20N			
	Cable O.D.	Standard	2mm to 3.5mm (0.078" to 0.137")		
		Large clamp / boot (Option "J")	3mm to 5mm (0.118" to 0.196")		
	Mechanical Operations	5000 mating cycles			2000 mating cycles
Weight	13.5g (0.029lb)				
<b>MATERIALS</b>	Connector Shell	Bronze & Zinc			
	Connector Shell Finish	Nickel Plated			
	Insulators	PPS - Black			
	Male Contact	Material - Brass C3604 Plating - Gold over Silver Plated			
	Female Contact	Material - Brass C5210P Plating - Gold over Silver Plated			
	Latch Lock and Spring	SUS (AISI - 301) - Nickel Plated			
	Adaptor	PPS - Black			
	Cable Clamp	Bronze - Nickel Plated			
	Boot/Backshell	ABS - Black			
	Grommet	PU - Black			

Rev 6 - 08/2019

<sup>1)</sup>Approximate weight only, does not include packaging. Please contact us for exact weight for shipping purposes.  
Not suitable for voltages over 50V.

# XLR Connectors

## G-Type Miniature XLR Connectors

### PANEL CUTOUTS - CONNECTOR SIDE OF PCB

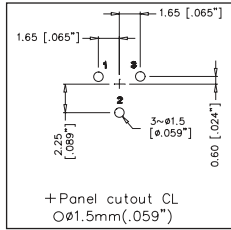

**AG3MCC**

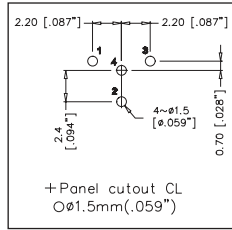

**AG4MCC**

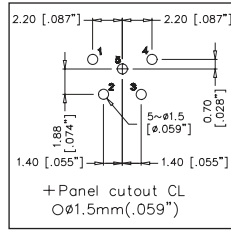

**AG5MCC**

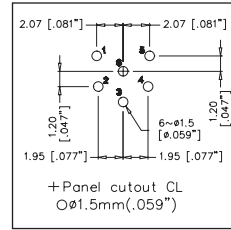

**AG6MCC**

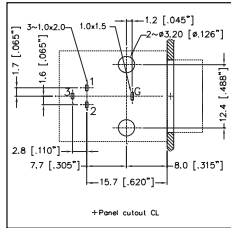

**AG3FCCH**

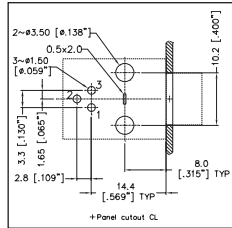

**AG3MCCCH**

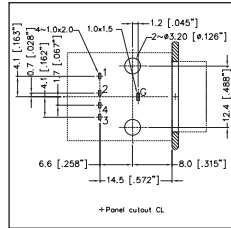

**AG4FCCH**

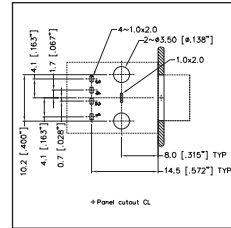

**AG4MCCCH**

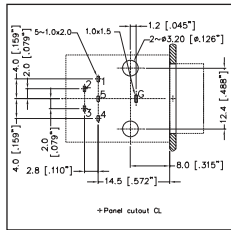

**AG5FCCH**

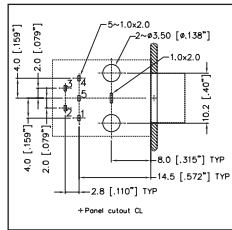

**AG5MCCCH**

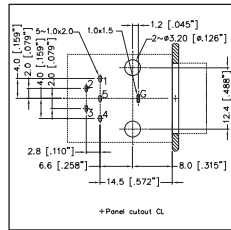

**AG6FCCH**

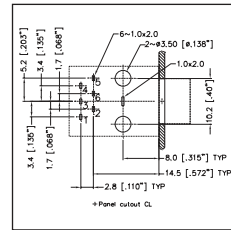

**AG6MCCCH**

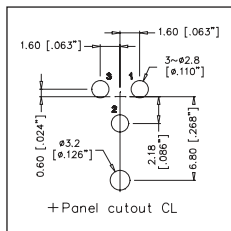

**AG3FCRV**

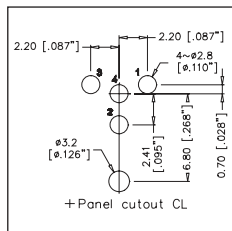

**AG4FCRV**

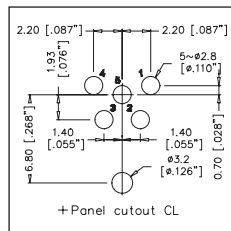

**AG5FCRV**

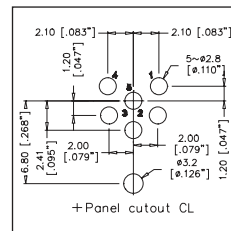

**AG6FCRV**

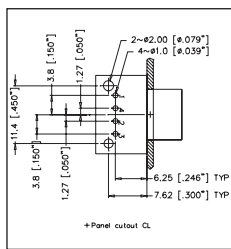

**AG4MPCH**

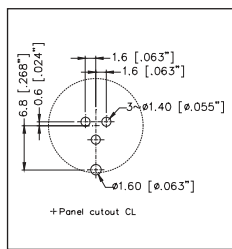

**AG3FCE**

### PANEL CUTOUTS - FRONT VIEW

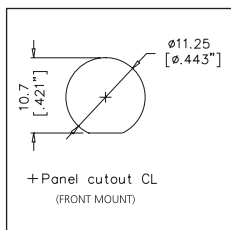

**AG3MCC  
AG4MCC  
AG5MCC  
AG6MCC**

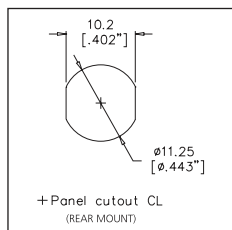

**AG3MCCCH  
AG4MCCCH  
AG5MCCCH  
AG6MCCCH  
AG4MPCH**

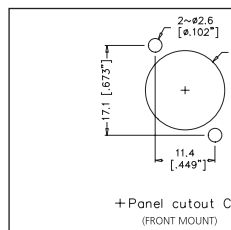

**AG3FCRV  
AG4FCRV  
AG5FCRV  
AG6FCRV**

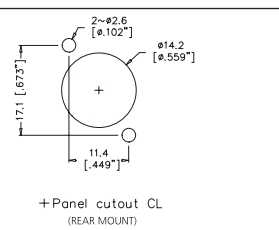

**AG3FCRV  
AG4FCRV  
AG5FCRV  
AG6FCRV**