

## High Temperature, Vibration Rejecting $\pm 2000^\circ/\text{sec}$ Gyroscope

### FEATURES

- ▶ Innovative ceramic vertical mount package can be oriented for pitch or roll rate response
- ▶ Wide temperature range:  $-40^\circ\text{C}$  to  $+175^\circ\text{C}$
- ▶ Long life: guaranteed 1000 hours at  $T_A = 175^\circ\text{C}$
- ▶ High vibration rejection over wide frequency
- ▶ 10,000 g powered shock survivability
- ▶ Ratiometric to referenced supply
- ▶ 5 V single-supply operation
- ▶ Self-test on digital command
- ▶ Temperature sensor output

### APPLICATIONS

- ▶ Down hole measurements for geological exploration
- ▶ Extreme high temperature industrial applications
- ▶ Severe mechanical environments

### FUNCTIONAL BLOCK DIAGRAM

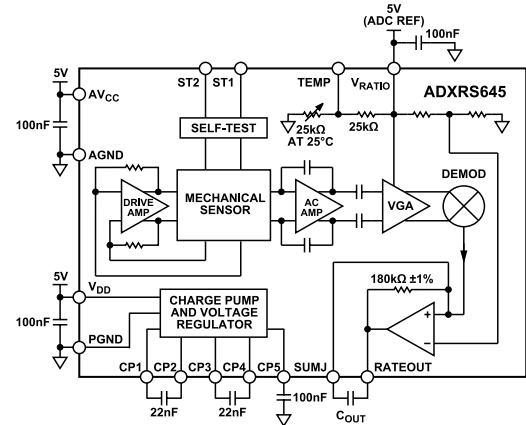

Figure 1.

### GENERAL DESCRIPTION

The ADXRS645 is a high performance angular rate sensor with excellent vibration immunity for use in high temperature environments. The ADXRS645 is manufactured using the Analog Devices, Inc., patented high volume BiMOS surface-micromachining process with years of proven field reliability. An advanced, differential, quad sensor design provides superior acceleration and vibration rejection.

The output signal, RATEOUT, is a voltage proportional to the angular rate about the axis normal to the package lid. The measurement range is a minimum of  $\pm 2000^\circ/\text{sec}$ , and may be extended to  $\pm 5000^\circ/\text{sec}$  with the addition of a single external resistor. The output is ratiometric with respect to a provided reference supply. Other external capacitors are required for operation.

A temperature output is provided for compensation techniques. Two digital self-test inputs electromechanically excite the sensor to test proper operation of both the sensor and the signal conditioning circuits. The ADXRS645 is available in an **8 mm × 9 mm × 3 mm, 15-lead brazed lead tri in-line package**.

**TABLE OF CONTENTS**

Features.....	1	Theory of Operation.....	10
Applications.....	1	Setting Bandwidth.....	10
Functional Block Diagram.....	1	Temperature Output and Calibration.....	10
General Description.....	1	Supply Ratiometricity.....	10
Specifications.....	3	Range Extension.....	10
Absolute Maximum Ratings.....	5	Self-Test Function.....	10
Recommended Soldering Profile.....	5	Continuous Self-Test.....	10
Rate Sensitive Axis.....	5	Outline Dimensions.....	11
ESD Caution.....	5	Ordering Guide.....	11
Pin Configuration and Function Descriptions.....	6	Evaluation Boards.....	11
Typical Performance Characteristics.....	7		

**REVISION HISTORY****2/2022—Rev. B to Rev. C**

Added Recommended Soldering Profile Section.....	5
Change to Setting Bandwidth Section.....	10

## SPECIFICATIONS

All minimum and maximum specifications are guaranteed. Typical specifications are not guaranteed.  $T_A = 25^\circ\text{C}$ ,  $V_S = AV_{CC} = V_{DD} = 5\text{ V}$ ,  $V_{RATIO} = AV_{CC}$ , angular rate =  $0^\circ/\text{sec}$ , bandwidth = 80 Hz ( $C_{OUT} = 0.01\ \mu\text{F}$ ), and  $I_{OUT} = 100\ \mu\text{A}$ , unless otherwise noted.

Table 1.

Parameter	Test Conditions/Comments	Min	Typ	Max	Unit
SENSITIVITY <sup>1</sup>	Clockwise rotation is positive output				
Measurement Range <sup>2, 3</sup>			±2000		$^\circ/\text{sec}$
Initial	$T_A = 25^\circ\text{C}$		1		$\text{mV}/^\circ/\text{sec}$
Temperature Drift	Uncompensated, $-40^\circ\text{C}$ to $+150^\circ\text{C}$ <sup>4</sup>		±5		%
	Uncompensated, $150^\circ\text{C}$ to $175^\circ\text{C}$		-35		%
Nonlinearity	Best fit straight line		0.1		% of FS
NULL <sup>1</sup>					
Initial	$T_A = 25^\circ\text{C}$	2.4	2.5	2.6	V
Temperature Drift	Uncompensated, $-40^\circ\text{C}$ to $+150^\circ\text{C}$ <sup>4</sup>		±50		$^\circ/\text{sec}$
	Uncompensated, $150^\circ\text{C}$ to $175^\circ\text{C}$		±150		$^\circ/\text{sec}$
Linear Acceleration Effect	Any axis		0.1		$^\circ/\text{sec}/g$
Vibration Rectification	25 g rms, 50 Hz to 5 kHz		0.0006		$^\circ/\text{sec}/g^2$
NOISE PERFORMANCE					
Rate Noise Density	$T_A \leq 25^\circ\text{C}$		0.25		$^\circ/\text{sec}/\sqrt{\text{Hz}}$
Resolution Floor	$T_A = 25^\circ\text{C}$ , 1 minute to 1 hour in-run		100		$^\circ/\text{hr}$
	$T_A = 150^\circ\text{C}$ , 1 minute to 1 hour in-run		150		$^\circ/\text{hr}$
FREQUENCY RESPONSE					
Bandwidth ( $\pm 3\text{ dB}$ ) <sup>5</sup>	No external filter		2000		Hz
Sensor Resonant Frequency		15.5	17.5	20	kHz
SELF-TEST <sup>1</sup>					
ST1 RATEOUT Response	ST1 pin from Logic 0 to Logic 1		-1300		$^\circ/\text{sec}$
ST2 RATEOUT Response	ST2 pin from Logic 0 to Logic 1		1300		$^\circ/\text{sec}$
ST1 to ST2 Mismatch <sup>6</sup>			±2		%
Logic 1 Input Voltage		3.3			V
Logic 0 Input Voltage				1.7	V
Input Impedance	To common	40	50	100	k $\Omega$
TEMPERATURE SENSOR <sup>1</sup>					
$V_{TEMP}$ at $25^\circ\text{C}$	Load = 10 M $\Omega$	2.3	2.4	2.5	V
Scale Factor <sup>7</sup>	$25^\circ\text{C}$ , $V_{RATIO} = 5\text{ V}$		9		$\text{mV}/^\circ\text{C}$
TURN-ON TIME <sup>8</sup>	Power on to $\pm 2^\circ/\text{sec}$ of final with $CP5 = 100\text{ nF}$		50		ms
OUTPUT DRIVE CAPABILITY					
Current Drive	For rated specifications			200	$\mu\text{A}$
Capacitive Load Drive				1000	pF
POWER SUPPLY					
Operating Voltage ( $V_S$ )		4.75	5.00	5.25	V
Quiescent Supply Current			3.5		mA
TEMPERATURE RANGE					
Specified Performance		-40		+175	$^\circ\text{C}$
LIFESPAN					
Usable Life Expectancy	$T_A = 175^\circ\text{C}$	1000			Hours

<sup>1</sup> Parameter is linearly ratiometric with  $V_{RATIO}$ .

<sup>2</sup> Measurement range is the maximum range possible, including output swing range, initial offset, sensitivity, offset drift, and sensitivity drift at 5 V supplies.

<sup>3</sup> Measurement range can be extended to as much as  $\pm 5000^\circ/\text{s}$  by adding a single 120 k $\Omega$  resistor between the RATEOUT and SUMJ pins.

<sup>4</sup> Maximum deviation from  $+25^\circ\text{C}$  to  $-40^\circ\text{C}$  or  $+25^\circ\text{C}$  to  $+150^\circ\text{C}$ , see the [Typical Performance Characteristics](#) section for typical behavior over temperature.

**SPECIFICATIONS****Table 1.**

Parameter	Test Conditions/Comments	Min	Typ	Max	Unit
-----------	--------------------------	-----	-----	-----	------

<sup>5</sup> Adjusted by the external capacitor, C<sub>OUT</sub>. Reducing bandwidth below 0.01 Hz does not result in further noise improvement.

<sup>6</sup> Self-test mismatch is described as  $(ST2 + ST1)/((ST2 - ST1)/2)$ .

<sup>7</sup> Scale factor for a change in temperature from 25°C to 26°C. V<sub>TEMP</sub> is ratiometric to V<sub>RATIO</sub>.

<sup>8</sup> Based on characterization.

## ABSOLUTE MAXIMUM RATINGS

Table 2.

Parameter	Rating
Acceleration (Any Axis, 0.5 ms)	
Unpowered	10,000 g
Powered	10,000 g
$V_{DD}$ , $AV_{CC}$	-0.3 V to +6.6 V
$V_{RATIO}$	$AV_{CC}$
ST1, ST2	$AV_{CC}$
Output Short-Circuit Duration (Any Pin to Common)	Indefinite
Operating Temperature Range	-55°C to +175°C
Storage Temperature Range	-65°C to +185°C

Stresses at or above those listed under Absolute Maximum Ratings may cause permanent damage to the product. This is a stress rating only; functional operation of the product at these or any other conditions above those indicated in the operational section of this specification is not implied. Operation beyond the maximum operating conditions for extended periods may affect product reliability.

Drops onto hard surfaces can cause shocks of greater than 10,000 g and can exceed the absolute maximum rating of the device. Exercise care in handling to avoid damage.

## RECOMMENDED SOLDERING PROFILE

Wave soldering is the recommended process for the ADXRS645. The process is aligned with standard practices defined in IPC-7530A. This process includes proper controls for flux spraying, preheating, wave soldering, and cooling operations.

## RATE SENSITIVE AXIS

The ADXRS645 produces a positive output voltage for clockwise rotation about the axis normal to the package lid, that is, clockwise when looking at the package lid.

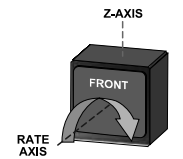

Figure 2. RATEOUT Signal Increases with Clockwise Rotation

## ESD CAUTION



**ESD (electrostatic discharge) sensitive device.** Charged devices and circuit boards can discharge without detection. Although this product features patented or proprietary protection circuitry, damage may occur on devices subjected to high energy ESD. Therefore, proper ESD precautions should be taken to avoid performance degradation or loss of functionality.

**PIN CONFIGURATION AND FUNCTION DESCRIPTIONS**

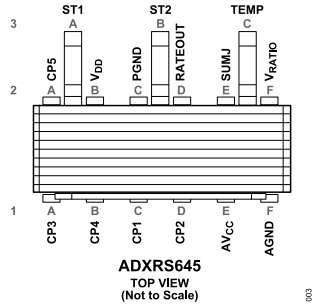

Figure 3. Pin Configuration (Top View)

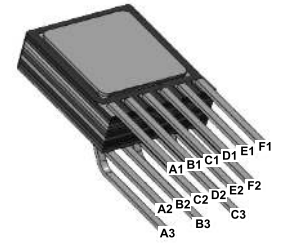

Figure 4. Pin Configuration (3D View)

Table 3. Pin Function Descriptions

Pin Number	Mnemonic	Description
A1	CP3	Charge pump capacitor, 22 nF
A2	CP5	HV filter capacitor, 100 nF
A3	ST1	Positive self-test
B1	CP4	Charge pump capacitor, 22 nF
B2	V <sub>DD</sub>	Positive charge pump supply
B3	ST2	Negative self-test
C1	CP1	Charge pump capacitor, 22 nF
C2	PGND	Charge pump supply return
C3	TEMP	Temperature voltage output
D1	CP2	Charge pump capacitor, 22 nF
D2	RATEOUT	Rate signal output
E1	AV <sub>CC</sub>	Positive analog supply
E2	SUMJ	Output amplifier summing junction
F1	AGND	Analog supply return
F2	V <sub>RATIO</sub>	Reference supply for ratiometric output

TYPICAL PERFORMANCE CHARACTERISTICS

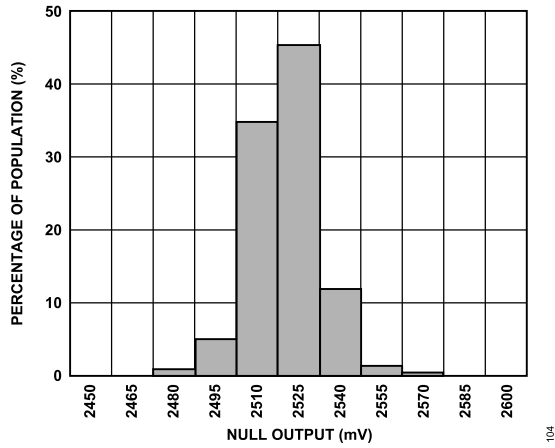

Figure 5. Null Output at 25°C

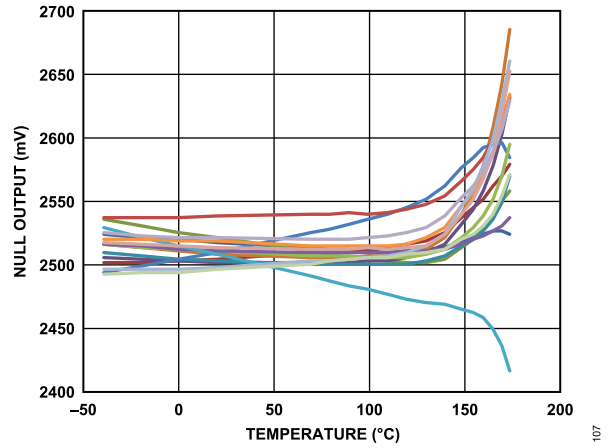

Figure 8. Null Output Over Temperature

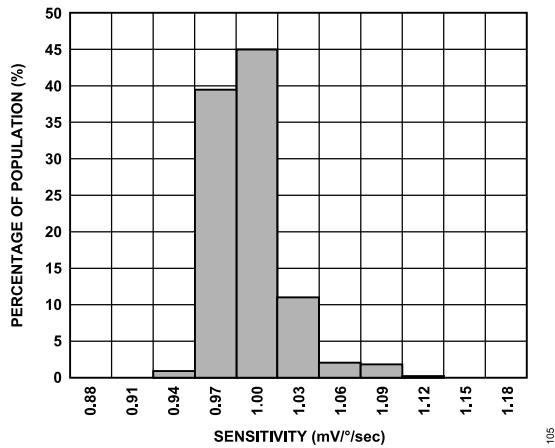

Figure 6. Sensitivity at 25°C

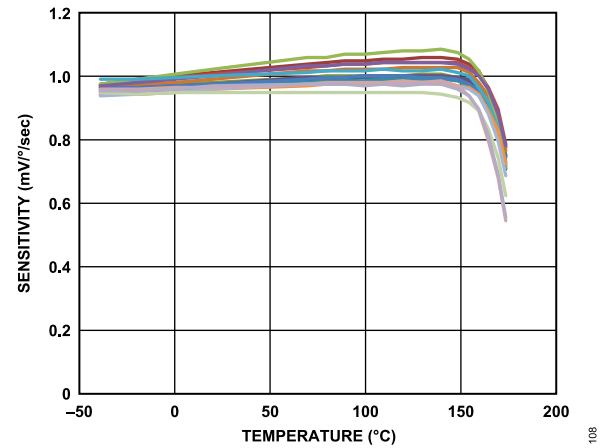

Figure 9. Sensitivity Over Temperature

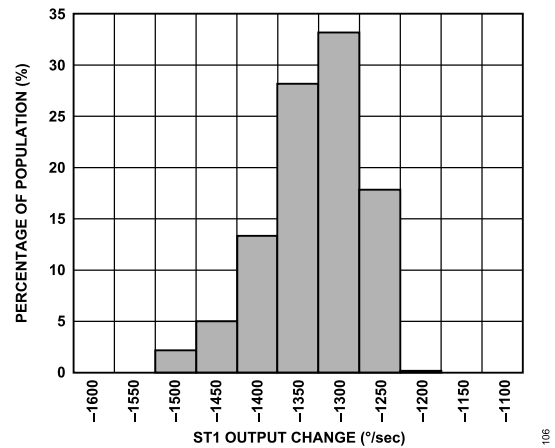

Figure 7. ST1 Output Change at 25°C ( $V_{RATIO} = 5 V$ )

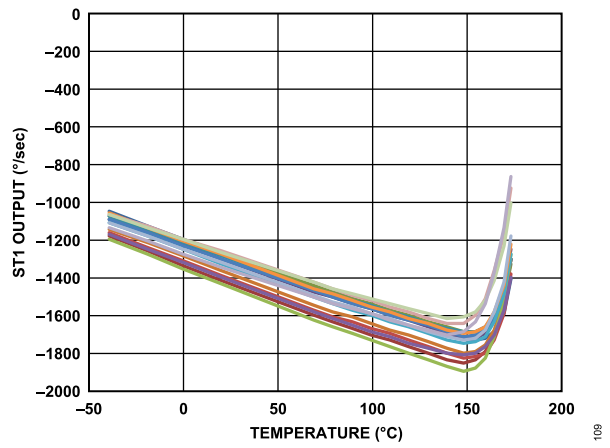

Figure 10. ST1 Output Over Temperature

TYPICAL PERFORMANCE CHARACTERISTICS

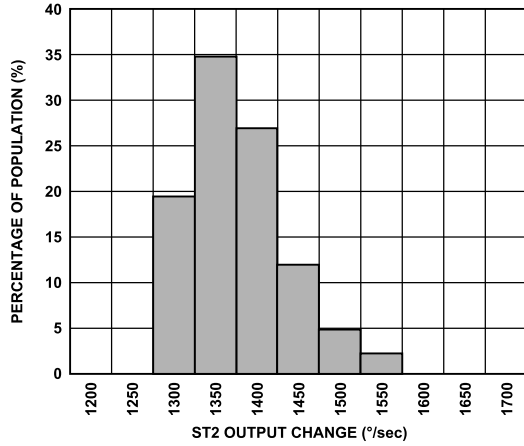

Figure 11. ST2 Output Change at 25°C ( $V_{RATIO} = 5 V$ )

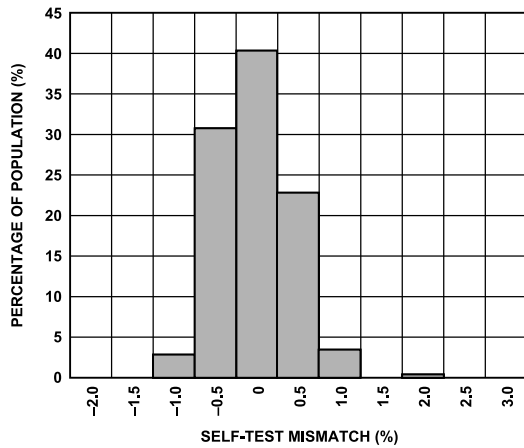

Figure 12. Self-Test Mismatch at 25°C ( $V_{RATIO} = 5 V$ )

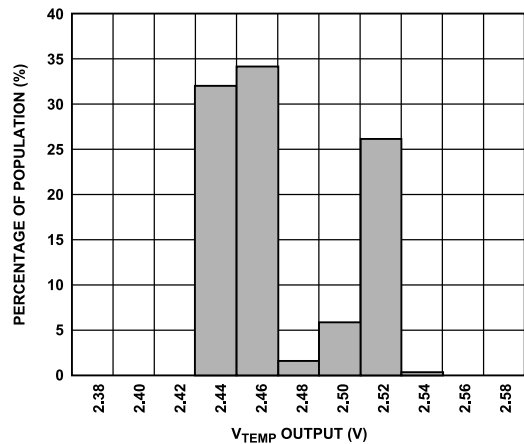

Figure 13.  $V_{TEMP}$  Output at 25°C

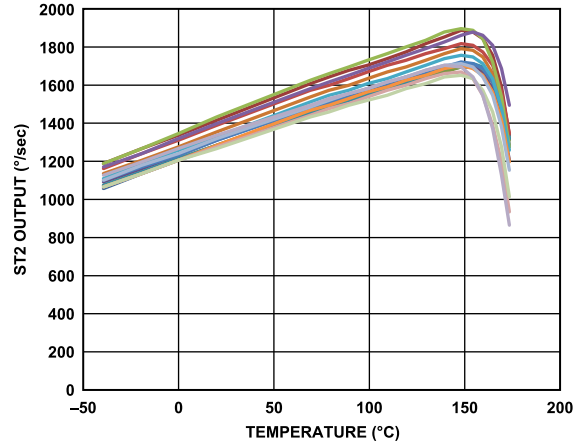

Figure 14. ST2 Output Over Temperature

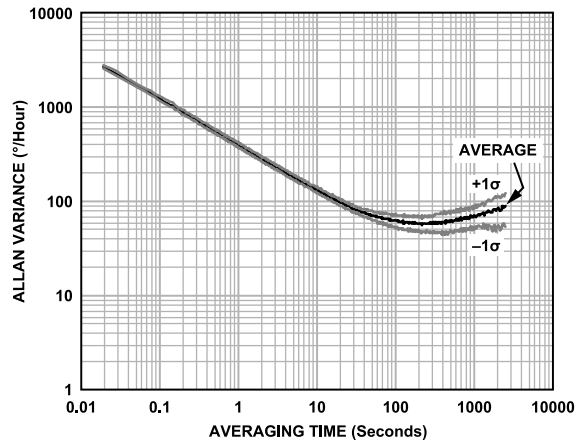

Figure 15. Allan Variance at 25°C vs. Averaging Time

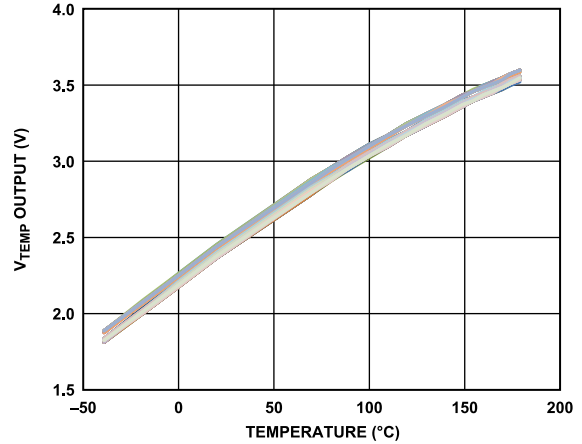

Figure 16.  $V_{TEMP}$  Output Over Temperature



TYPICAL PERFORMANCE CHARACTERISTICS

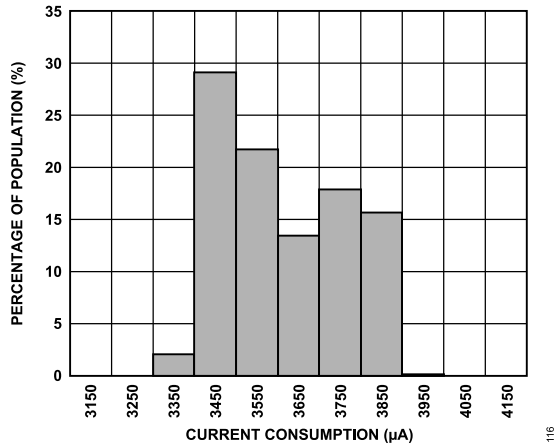

Figure 17. Current Consumption at 25°C ( $V_{RATIO} = 5 V$ )

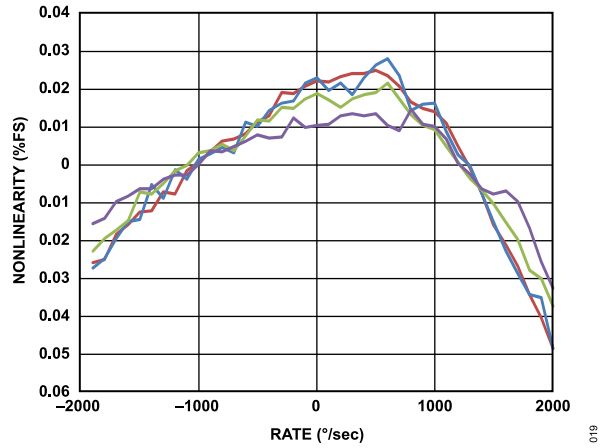

Figure 20. Typical Output Nonlinearity

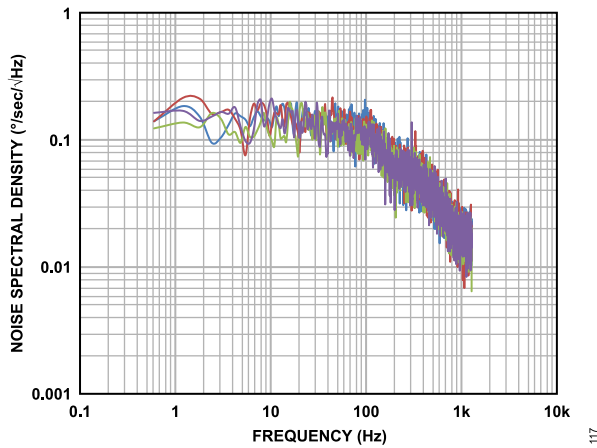

Figure 18. Typical Noise Spectral Density ( $C_{OUT} = 0.01 \mu F$ )

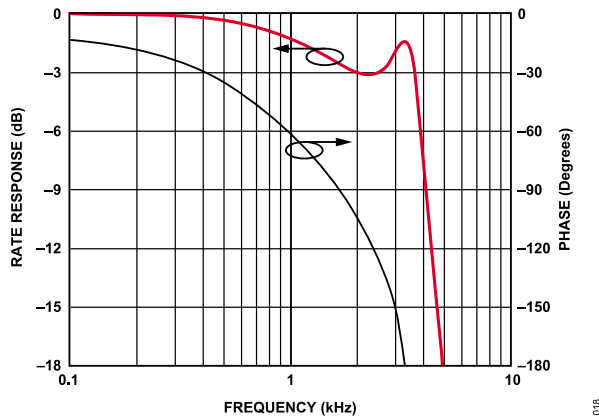

Figure 19. Typical Rate and Phase Response vs. Frequency ( $C_{OUT} = 470 pF$  with a Series RC Low-Pass Filter of  $3.3 k\Omega$  and  $22 nF$ )

## THEORY OF OPERATION

The ADXRS645 operates on the principle of a resonator gyroscope. Two polysilicon sensing structures each contain a dither frame that is electrostatically driven to resonance, producing the necessary velocity element to produce a Coriolis force during angular rate. At two of the outer extremes of each frame, orthogonal to the dither motion, are movable fingers that are placed between fixed pickoff fingers to form a capacitive pickoff structure that senses Coriolis motion. The resulting signal is fed to a series of gain and demodulation stages that produce the electrical rate signal output. The dual sensor design rejects external g-forces and vibration. Fabricating the sensor with the signal conditioning electronics preserves signal integrity in noisy environments.

The electrostatic resonator requires 15 V for operation. Because only 5 V is typically available in most applications, a charge pump is included on chip. If an external 17 V to 22 V supply is available, the two capacitors on CP1 to CP4 can be omitted, and this supply can be connected to CP5 (Pin A2) through a 1 k $\Omega$  series resistor. Do not ground CP5 when power is applied to the ADXRS645. No damage occurs, but under certain conditions, the charge pump may fail to start up after the ground is removed without first removing power from the ADXRS645.

### SETTING BANDWIDTH

The external capacitor,  $C_{OUT}$ , is used in combination with the on-chip resistor,  $R_{OUT}$ , to create a low-pass filter to limit the bandwidth of the ADXRS645 rate response. The -3 dB frequency set by  $R_{OUT}$  and  $C_{OUT}$  is

$$f_{OUT} = 1/(2 \times \pi \times R_{OUT} \times C_{OUT})$$

This frequency can be well controlled because  $R_{OUT}$  has been trimmed during manufacturing to be 180 k $\Omega \pm 1\%$ . Any external resistor applied between the RATEOUT pin (D2) and SUMJ pin (E2) results in  $R_{OUT} = (180 \text{ k}\Omega \times R_{EXT})/(180 \text{ k}\Omega + R_{EXT})$ .

In general, an additional filter (in either hardware or software) is added to attenuate high frequency noise arising from demodulation spikes at the 18 kHz resonant frequency of the gyroscope. An RC output filter consisting of a 3.3 k $\Omega$  series resistor and 22 nF shunt capacitor (2.2 kHz pole) is recommended.

### TEMPERATURE OUTPUT AND CALIBRATION

It is common practice to temperature calibrate gyroscopes to improve their overall accuracy. The ADXRS645 has a temperature proportional voltage output that provides input to such a calibration method. The temperature sensor structure is shown in [Figure 21](#).

The voltage at TEMP (Pin C3) is nominally 2.4 V at 25°C, and  $V_{RATIO} = 5 \text{ V}$ . The temperature coefficient is  $\sim 9 \text{ mV}/^\circ\text{C}$  at 25°C. Although the TEMP output is highly repeatable, it has only modest absolute accuracy.

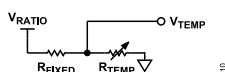

Figure 21. Temperature Sensor Structure

### SUPPLY RATIOMETRICITY

The RATEOUT, ST1, ST2, and TEMP signals of the ADXRS645 are ratiometric to the  $V_{RATIO}$  voltage, that is, the null voltage, rate sensitivity, and temperature outputs are proportional to  $V_{RATIO}$ . Therefore, it is most easily used with a supply ratiometric analog-to-digital converter (ADC), which results in self cancellation of errors due to minor supply variations. There is some small, usually negligible, error due to nonratiometric behavior. Note that, to guarantee full rate range,  $V_{RATIO}$  must not be greater than  $AV_{CC}$ .

### RANGE EXTENSION

The ADXRS645 scale factor can be reduced to extend the measurement range to as much as  $\pm 5000^\circ/\text{sec}$  by adding a single 120 k $\Omega$  resistor between the RATEOUT and SUMJ pins. If an external resistor is added between the RATEOUT and SUMJ pins, proportionally increase  $C_{OUT}$  to maintain correct bandwidth (that is, if adding a 180 k $\Omega$  resistor, double  $C_{OUT}$ ).

### SELF-TEST FUNCTION

The ADXRS645 includes a self-test feature that actuates each of the sensing structures and associated electronics in the same manner, as if subjected to angular rate. It is activated by standard logic high levels applied to ST1 (Pin A3), ST2 (Pin B3), or both. ST1 causes the voltage at RATEOUT to change about -1.3 V, and ST2 causes an opposite change of +1.3 V. The self-test response follows the viscosity temperature dependence of the package atmosphere, approximately 0.25%/°C.

Activating both ST1 and ST2 simultaneously is not damaging. ST1 and ST2 are fairly closely matched ( $\pm 1\%$ ), but actuating both simultaneously may result in a small apparent null bias shift proportional to the degree of self-test mismatch.

ST1 and ST2 are activated by applying a voltage equal to  $V_{RATIO}$  to the ST1 pin and the ST2 pin. The voltage applied to ST1 and ST2 must never be greater than  $AV_{CC}$ .

### CONTINUOUS SELF-TEST

The on-chip integration of the ADXRS645 gives it higher reliability than is obtainable with any other high volume manufacturing method. In addition, it is manufactured under a mature BiMOS process that has field proven reliability. As an additional failure detection measure, power-on self-test can be performed. However, some applications may warrant continuous self-test while sensing rate.

OUTLINE DIMENSIONS

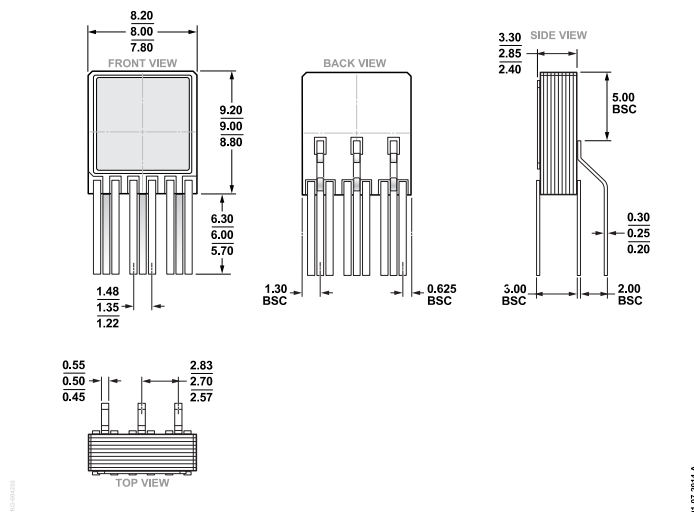

Figure 22. 15-Lead Brazed Lead Tri In-line Package [BL\_TIP] (DY-15-1)  
Dimensions shown in millimeters

Updated: January 18, 2022

ORDERING GUIDE

Model <sup>1</sup>	Temperature Range	Package Description	Packing Quantity	Package Option
ADXRS645HDYZ	-40°C to +175°C	15-Lead Ceramic DIP Vertical Form	Tray, 96	DY-15-1

<sup>1</sup> Z = RoHS Compliant Part.

EVALUATION BOARDS

Model <sup>1</sup>	Description
EVAL-ADXRS645Z	Evaluation Board

<sup>1</sup> Z = RoHS Compliant Part.