

Product Number	Packaging
10126909-101LF	Tray

A

B

C

D

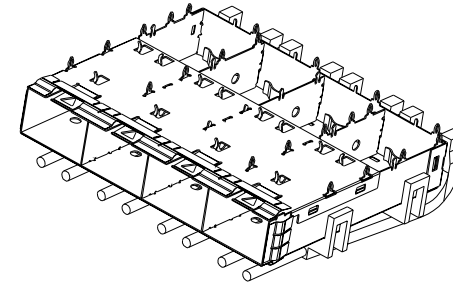
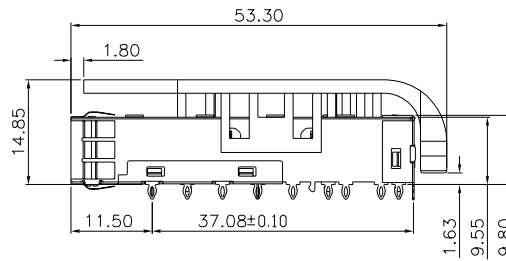
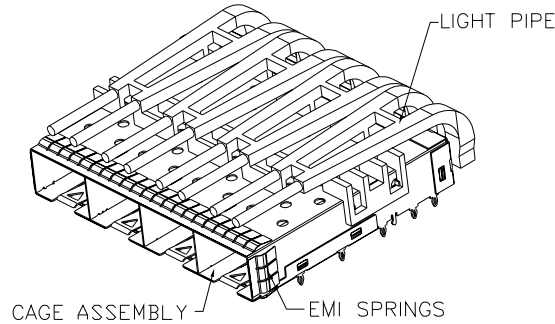
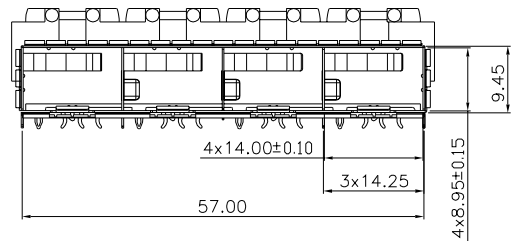
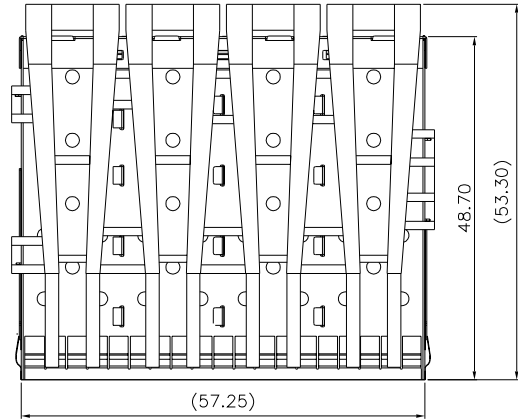

A

B

C

D

NOTES:

- | 1, DESCRIPTION | Q'ty | MATERIAL | PLATING |
|----------------|------|----------------------------|------------|
| CAGE ASSEMBLY | 1PCS | NICKEL SILVER ALLOY T=0.25 | NO PLATING |
| EMI SPRINGS | 4PCS | COPPER ALLOY T=0.08 | Ni PLATED |
| LIGHT PIPE | 1PCS | POLYCARBONATE.CLEAR | NO PLATING |
- 2, PRODUCT SPECIFICATION: GS-12-1165
3, APPLICATION SPECIFICATION: GS-20-0384
4, PACKAGE PER GS-14-2344 AND GS-14-920

Copyright FCI.

spec ref	RELEASE			dr	Art Lin	2014-01-13	projection 	MM 	size	scale
tolerance std	TOLERANCES UNLESS OTHERWISE SPECIFIED			eng	Zhen Luo	2014-01-13			A4	1:1
ISO406 ISO1101				chr	Collins Lu	2014-01-14			ecn no	
surface	linear	0.X	±0.25	www.fci.com	title	SFP+ 1X4 CAGE ASSEMBLY EMI SPRING TYPE PRESS FIT WITH LIGHTPIPE	product family	SFP+	rel level	Released
ISO1302		0.XX	±0.20							
	angular	0°	±0.5°							
				www.fci.com		cat. no.	-	Product-Customer Drw	sheet 1 of 3	

Proj/E File - REV C - 2009-06-09

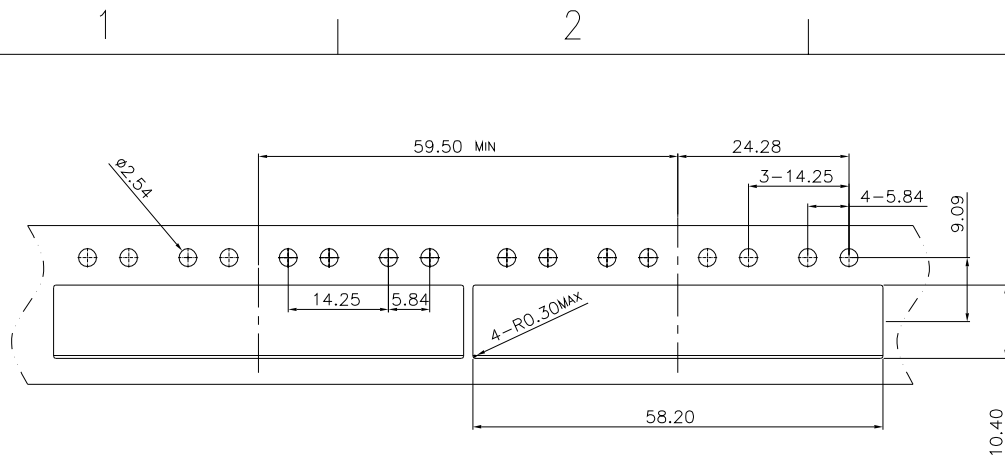

BEZEL CUT-OUT SINGLE SIDED APPLICATIONS

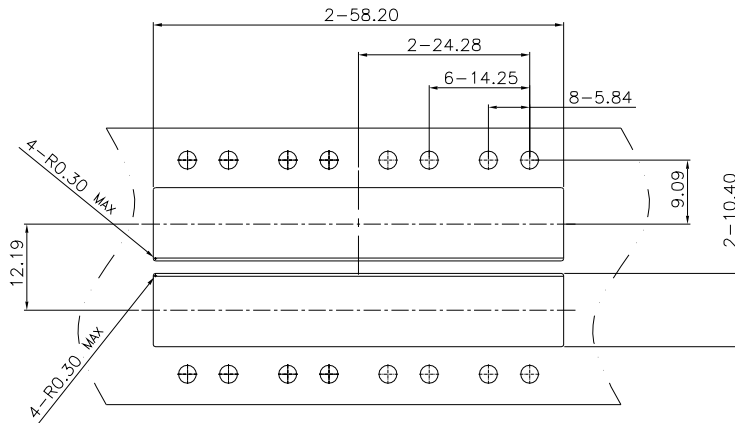

RECOMMENDED BEZEL CUT-OUT BELLY TO BELLY APPLICATIONS

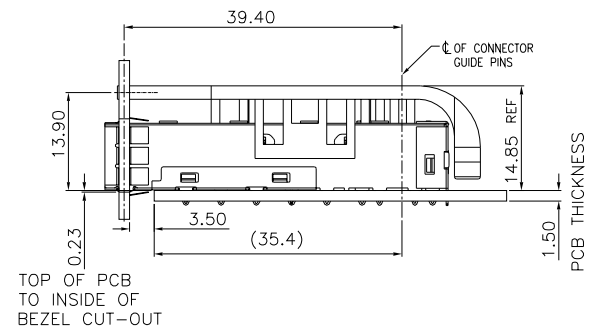

MOUNTED ON PC BOARD SHOWN THRU RECOMMENDED BEZEL

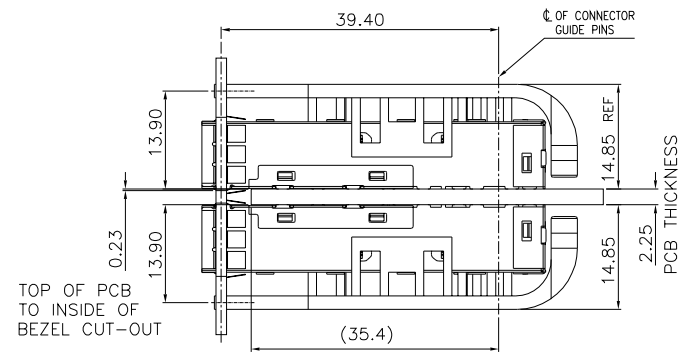

MOUNTED BELLY TO BELLY ON PC BOARD SHOWN THRU RECOMMENDED BEZEL



Copyright FCI.

spec ref	RELEASE	dr	Art Lin	2014-01-13	projection 	MM ←→	size	scale		
tolerance std	TOLERANCES UNLESS OTHERWISE SPECIFIED	eng	Zhen Luo	2014-01-13			A4	1:1		
ISO406 ISO1101		chr	Collins Lu	2014-01-14			ecn no			
surface	linear	appr	JEFFREY QIN	2014-01-14	product family	SFP+	rel level	Released		
ISO1302		angular	www.fci.com		title	SFP+ 1X4 CAGE ASSEMBLY EMI SPRING TYPE PRESS FIT WITH LIGHTPIPE		dwg no	10126909	rev
	0.X	±0.25		cat. no.		-	Product-Customer Drw			
	0.XX	±0.20								
	0.XXX	±0.15								
	0°	±0.5°								

Pro/E File - REV C - 2009-06-09

