

1534072-3 ✓ ACTIVE

RAST | RAST 5 IDC Connectors

TE Internal #: 1534072-3

Standard Rectangular Connectors, Connector Assembly,
Receptacle, Mating Alignment, Keyed Mating Alignment Type,
RAST 5 IDC Connectors

[View on TE.com >](#)



Connectors > Rectangular Connectors > Standard Rectangular Connectors

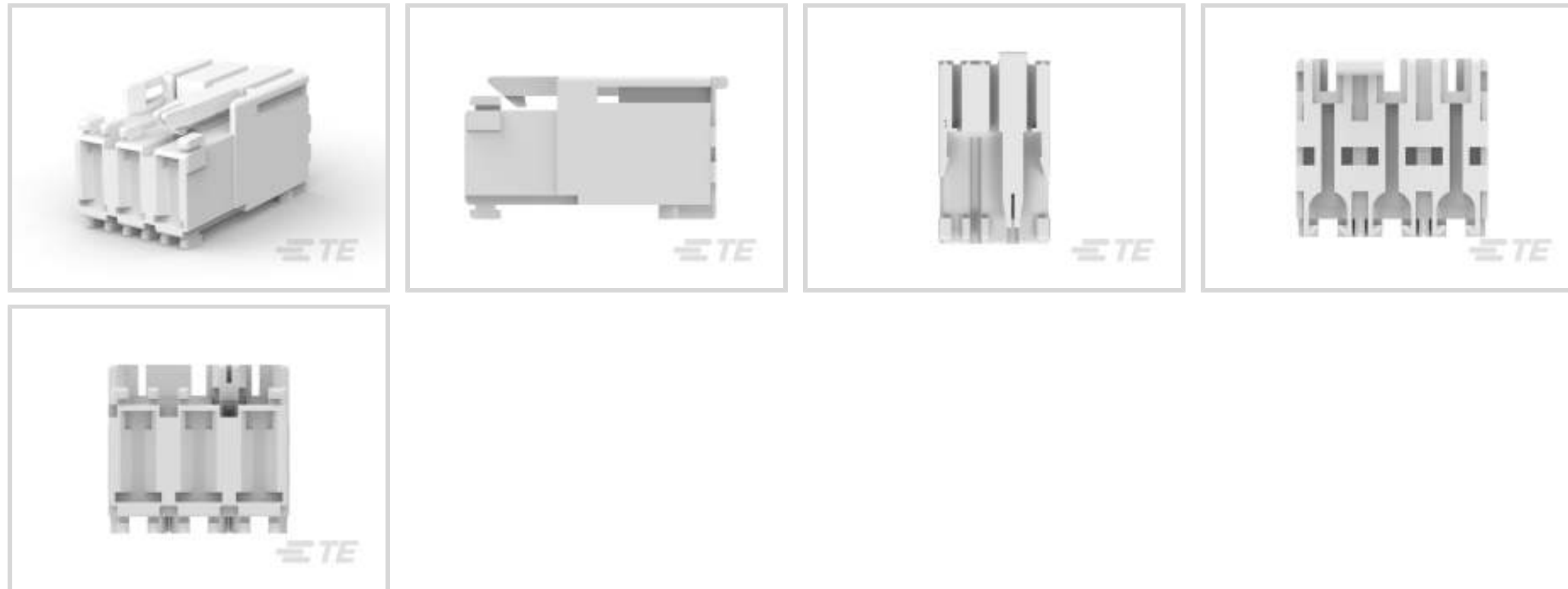

Connector Product Type: **Connector Assembly**

Connector & Housing Type: **Receptacle**

Mating Alignment: **With**

Mating Alignment Type: **Keyed**

Mating Retention: **With**

Features

Product Type Features

Connector Product Type	Connector Assembly
Connector & Housing Type	Receptacle
Connector System	Wire-to-Board
Sealable	No
Connector & Contact Terminates To	Wire & Cable

Configuration Features

Contacts Preloaded	Yes
Number of Columns	3
Number of Loaded Positions	3
Number of Positions	3
Number of Rows	1

Electrical Characteristics

Operating Voltage	250 VAC
-------------------	---------

Contact Features



Contact Layout	Inline
Wire Contact Termination Area Plating Material	Tin
Contact Mating Area Plating Material	Tin
Contact Retention Within Housing	Without
Contact Current Rating (Max)	10 A

Termination Features

Termination Method to Wire & Cable	Insulation Displacement (IDC)
------------------------------------	-------------------------------

Mechanical Attachment

Mating Alignment	With
Mating Alignment Type	Keyed
Mating Retention	With
Mating Retention Type	Locking Latch
Connector Mounting Type	Cable Mount (Free-Hanging)

Housing Features

Housing Material	PA 6.6
Housing Color	Natural
Centerline (Pitch)	5 mm [.196 in]

Usage Conditions

Operating Temperature Range	-40 – 110 °C [-40 – 230 °F]
-----------------------------	-----------------------------

Operation/Application

Shielded	No
Circuit Application	Power

Industry Standards

Agency/Standard	UL
UL Flammability Rating	UL 94V-2

Product Compliance

[For compliance documentation, visit the product page on TE.com>](#)

EU RoHS Directive 2011/65/EU	Compliant
EU ELV Directive 2000/53/EC	Compliant
China RoHS 2 Directive MIIT Order No 32, 2016	No Restricted Materials Above Threshold
EU REACH Regulation (EC) No. 1907/2006	



Current ECHA Candidate List: JUNE 2023
(235)
Candidate List Declared Against: JAN 2023
(233)
Does not contain REACH SVHC

Halogen Content Not Low Halogen - contains Br or Cl > 900 ppm.

Solder Process Capability Not applicable for solder process capability

Product Compliance Disclaimer

This information is provided based on reasonable inquiry of our suppliers and represents our current actual knowledge based on the information they provided. This information is subject to change. The part numbers that TE has identified as EU RoHS compliant have a maximum concentration of 0.1% by weight in homogenous materials for lead, hexavalent chromium, mercury, PBB, PBDE, DBP, BBP, DEHP, DIBP, and 0.01% for cadmium, or qualify for an exemption to these limits as defined in the Annexes of Directive 2011/65/EU (RoHS2). Finished electrical and electronic equipment products will be CE marked as required by Directive 2011/65/EU. Components may not be CE marked. Additionally, the part numbers that TE has identified as EU ELV compliant have a maximum concentration of 0.1% by weight in homogenous materials for lead, hexavalent chromium, and mercury, and 0.01% for cadmium, or qualify for an exemption to these limits as defined in the Annexes of Directive 2000/53/EC (ELV). Regarding the REACH Regulation, the information TE provides on SVHC in articles for this part number is based on the latest European Chemicals Agency (ECHA) 'Guidance on requirements for substances in articles' posted at this URL: <https://echa.europa.eu/guidance-documents/guidance-on-reach>

Compatible Parts



TE Part # 2366308-3
MULTIF.ASSY MK2 3POS,AR V0-GW



TE Part # 2316476-3
3P, RAST5 HEADER, DIN THV OPPOSITE WO PEG



TE Part # 2393854-3
AMP MULTIFITTING MKII ASSY 3P



TE Part # 2407711-3
Multifitting Mk2 assy 3P,10Asilver

Also in the Series | RAST 5 IDC Connectors



Automotive Terminals(8)



Connector Contacts(12)

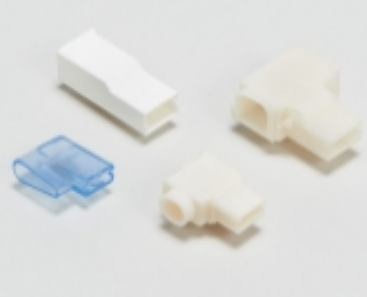

Crimp Terminal Housings(41)



Insertion & Extraction Tools(1)



PCB Headers & Receptacles(417)



Rectangular Connector Housings(1)

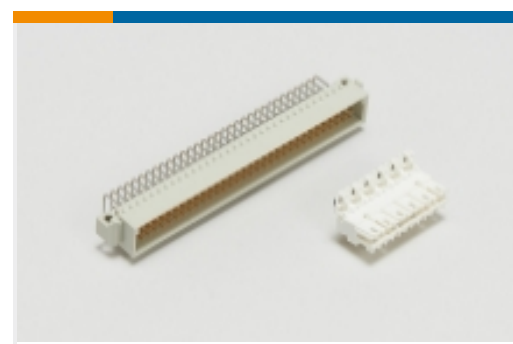

Standard Edge Connectors(34)



Standard Rectangular Connectors(68)

Wire-to-Board Connector Assemblies
& Housings(214)

Wire-to-Board Connector Contacts(2)

Customers Also Bought

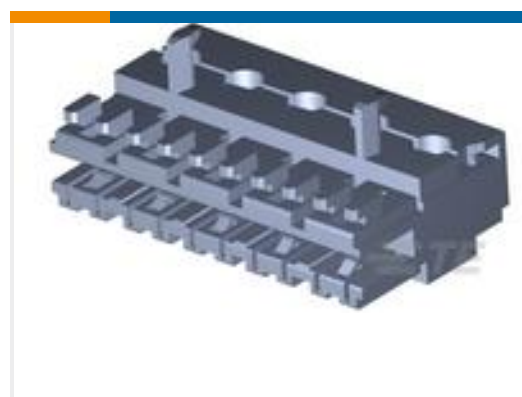
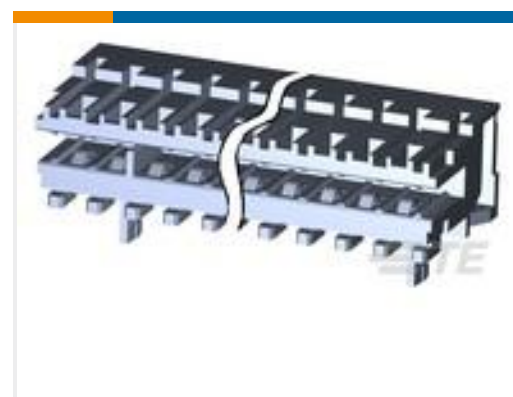
TE Part #1534415-5
DUOPL POW FEM CON5PTE Part #1534072-2
MULTIF.ASSY MK2 2POS,ARTE Part #3-1534796-8
AMP DUOPLUG MK2 CONNECTOR 8PTE Part #1534073-2
MULTIFIT MK2 ASSY2PTE Part #3-1534798-3
AMP DUOPLUG MK2 CONNECTOR
3P SELECTIVETE Part #1-100605-2
250 FASTON,REC.,14-17AWG,PTPBTE Part #1534077-3
MULTIFIT MK2ASSY 3P,IR

Documents

Product Drawings

[MULTIF.ASSY MK2 3POS,AR](#)

English

CAD Files

[3D PDF](#)

[3D](#)

[Customer View Model](#)

[ENG_CVM_CVM_1534072-3_J.2d_dxf.zip](#)



English

Customer View Model

[ENG_CVM_CVM_1534072-3_J.3d_igs.zip](#)

English

Customer View Model

[ENG_CVM_CVM_1534072-3_J.3d_stp.zip](#)

English

By downloading the CAD file I accept and agree to the [Terms and Conditions](#) of use.

Datasheets & Catalog Pages

[1654742_HOUSEHOLD_APPLIANCES_RAST5](#)

English

Product Specifications

[Application Specification](#)

English

Product Environmental Compliance

[Product Compliance Document](#)

English

[Product Compliance Document](#)

English

Agency Approvals

[VDE Certificate](#)

English

[VDE Certificate](#)

English