

KA-BAND BLOCK UPCONVERTER With HPA

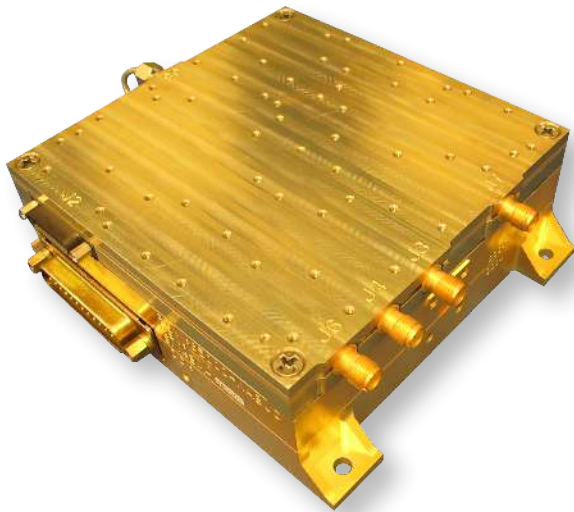

Features

- Compact Design
- Dual L Band Inputs
- Dual up conversion to ensure no phase inversion
- WR28 Output with Isolator
- PA Enable
- Digital Gain control
- Thermal Monitoring and Gain Compensation
- Size: 5.72" x 4.51" x 1.63"
- Weight: 2.11 lbs
- Designed for Military Environments

Typical Applications

- Satellite communications
 - Commercial
 - Military

General Description

The HMC7056A is a fully integrated Ka-Band Block Upconverter with HPA. The unit is designed for single carrier use in satellite communications. It covers both Commercial and Military bands and is designed to meet military environmental conditions.

Parameter	Typical
Input Frequency Range (GHz)	0.95 - 1.95 or 1 - 2
Output Frequency Range (GHz)	29 - 31
Conversion Gain (dB)	65
Gain Flatness -1 GHz (dB)	3
Gain Flatness -40 MHz (dB)	0.7
Input Power (dBm)	-30 - +5
Output Linear Power (PSK) (dBm)	+37
Phase Noise (dBc/Hz)	
10 Hz	-50
100 Hz	-66
1 kHz	-93
10 kHz	-92
100 kHz	-94
1 MHz	-104
10 MHz	-118
Spurious (dBc)	-60
AM/PM Conversion (Deg/dB)	2
BUC DC Power (VDC @ AMP)	5.75V @ 2.25 A
HPA DC Power (VDC @ AMP)	5.0V @ 14.0 A
Size (in)	5.72" x 4.51" x 1.63"

Functional Block Diagram

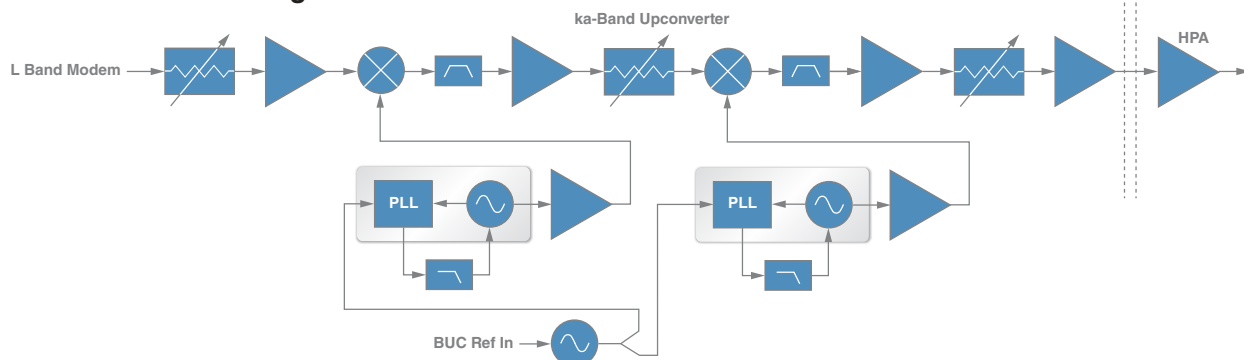

KA-BAND BLOCK UPCONVERTER With HPA

Electrical Specifications

Parameter	Specification			Units	Notes
	Min.	Typ.	Max.		
Input IF frequency Select 1 Input IF frequency Select 2	0.95 1		1.95 2	GHz	
Frequency range (MIL)	30		31	GHz	Military band
Frequency range (COMM)	29		30	GHz	Commercial band
Reference frequency		100		MHz	
Reference input power	-5		5	dBm	
Reference output power	-7.5		5	dBm	
Input IF Power			5	dBm	
Conversion gain	64		66	dB	
Gain flatness – 1GHz MIL Gain flatness – 1GHz COMM		3 3	3.5 (no max)	dB	
Gain flatness – 40MHz COMM Gain flatness – 5MHz COMM			0.7 0.4	dB	
Gain variation (over temp)			±1.0	dB	
Gain stability			±0.25	dB/24h	
Gain control	30			dB	
Group delay - 40MHz			±0.25	nSec	
Group delay - 10MHz			±0.1	nSec	
Internal TX (VSWR)		2:1			
External TX (VSWR)		2:1			
10MHz reference (VSWR)		2:1			
100MHz reference (VSWR)		2:1			
RF output (VSWR)		1.5:1			With external Isolator
Linear power		37		dBm	PSK
P1dB		38.5		dBm	
TX maximum power (Psat)		39.5		dBm	3dB compression
Output IP3		47.5		dBm	
Power added efficiency	6.5	6.8		%	
LO leakage			-20	dBm	
Image rejection			-60	dBc	
signal related spurious			-60	dBc	
Non-signal related spurs			-40	dBm	
TX single sideband spurs			-40	dBm	
Phase Noise					
10Hz		-50		dBc/Hz	
100Hz		-66		dBc/Hz	
1kHz		-93		dBc/Hz	
10kHz		-92		dBc/Hz	

KA-BAND BLOCK UPCONVERTER With HPA

Electrical Specifications

Parameter	Specification			Units	Notes
	Min.	Typ.	Max.		
100kHz		-94		dBc/Hz	
1MHz		-104		dBc/Hz	
10MHz		-118		dBc/Hz	
AM/PM conversion	0		2	Deg/dB	
PA mute attenuation	40			dB	
PA mute settling time		50	150	μs	
Int IF to Ext IF isolation	70			dB	
VDD (BUC)	5.5		5.9	VDC	
+21V	19.5		23	VDC	
VDD (HPA)	4.9		5.1	VDC	
-5V	-5.1		-4.9	VDC	
IDD (BUC)			2.5	A	
I (+21V)			50	mA	
I (-5V)			75	mA	
IDD (HPA)			14.3	A	
DC power Max (RF)			89	W	
DC power (HPA mute)			21	W	
HPA Temp sense	0		0.78	V	
VDD_HPA_SENSE/RTN	4.9		5.1	V	

**KA-BAND BLOCK UPCONVERTER
With HPA**

Figure 1. Small Signal Gain

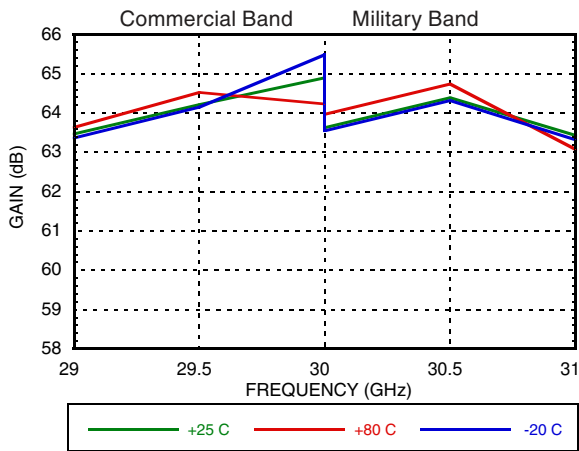

Figure 2. Output P1dB & PAE

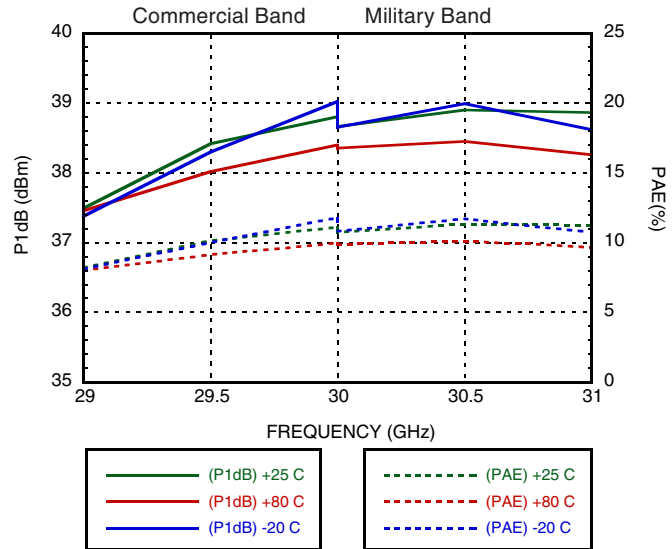

Figure 3. Saturated Output Power

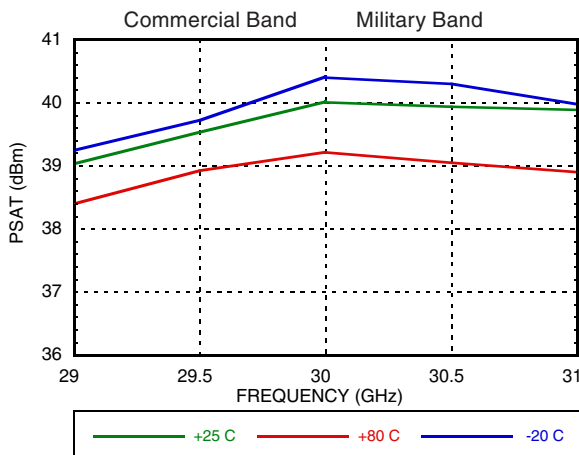

Figure 4. Linear Power (SRG)

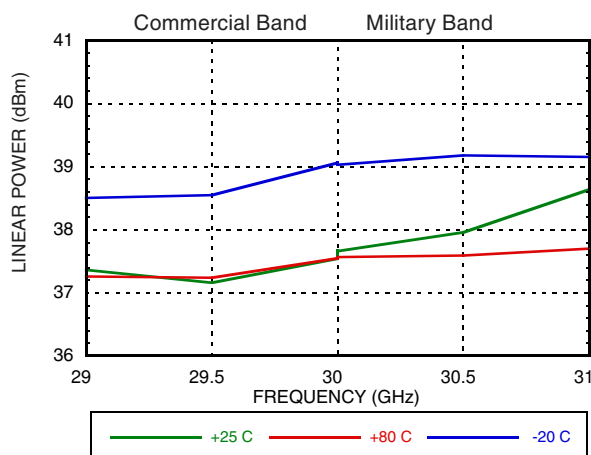

Figure 5. IP3

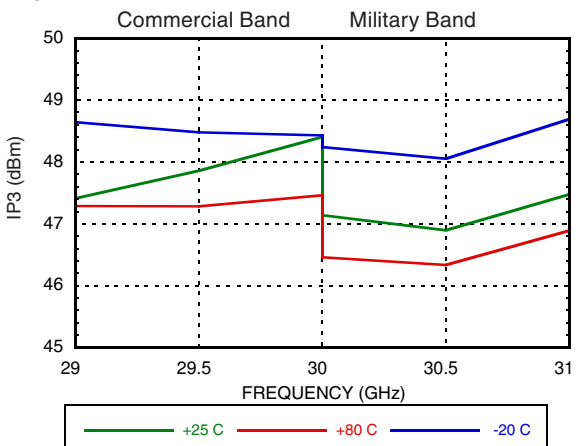
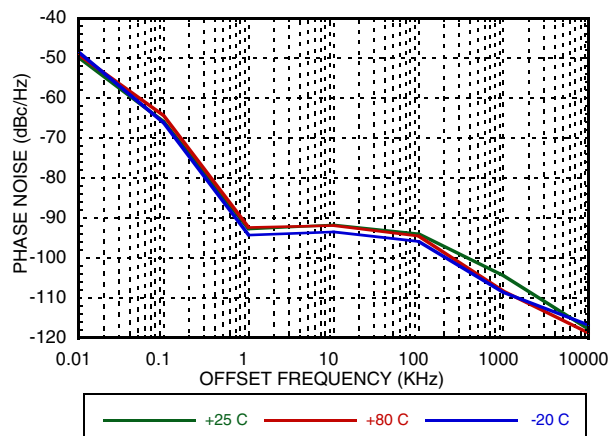
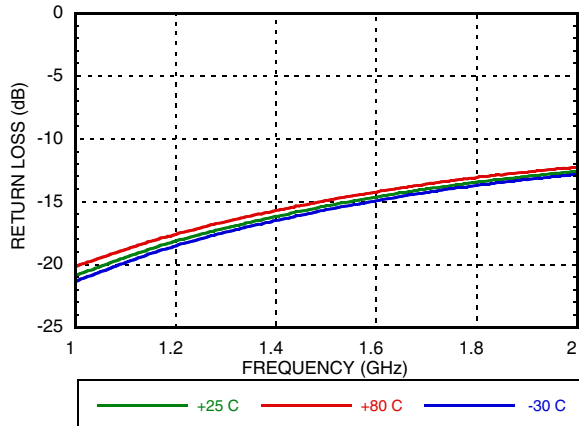

Figure 6. Phase Noise (carrier @ 30 GHz)



**KA-BAND BLOCK UPCONVERTER
With HPA**

Figure 7. Input Return Losses



**Figure 9. Output Return Losses
(Military Band)**

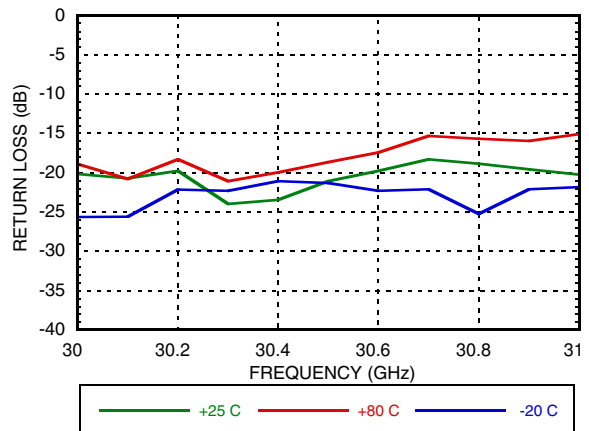

**Figure 8. Output Return Losses
(Commercial Band)**

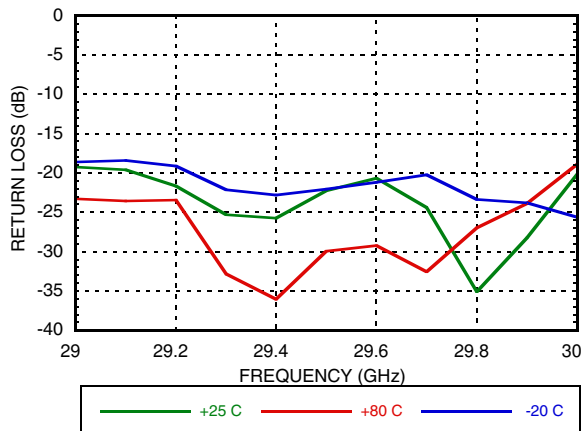

KA-BAND BLOCK UPCONVERTER With HPA

**Table 1. Absolute
Maximum Ratings**

Parameter	Max Rating
VDD_HPA	+5.5V
-5VDC_HPA	-6V
VDD_BUC	+20V
21VDC_BUC	+30V
-5VDC_BUC	-20V
Operating temp	-20 to +80°C
Storage temp	-55 to +125°C
Continuous Pdiss	70 watt
ESD sensitivity	Class 1A

Table 2. RF I/O Ports

Port #	I/O	Function	Description
J3	I	L_LP_INT_TX MDM_INT_10MHz_REF	Internal modem input with 10MHz reference signal
J4	I	L_LP_EXT_TX MDM_EXT_10MHz_REF	External modem input with 10MHz reference signal
J5	O	HPA_RF_OUT	Unit RF output port (WR28)
J6	O	BUC_10MHz_REF_OUT	10 MHz reference signal output
J7	I	BUC_100MHz_REF_IN	100 MHz reference signal input
J8	O	BUC_RF_OUT	Up-converter module (BUC) RF output port K(F)
J9	I	HPA_RF_IN	Power amplifier module (HPA) RF input port K(F)

Table 3. J1 HPA Connector Pin Out

Pin #	Signal/Voltage	Description
1	VDD_HPA	HPA drain Voltage
2	VDD_HPA	
3	VDD_HPA	
4	VDD_HPA	
5	VDD_HPA	
6	VDD_HPA	
7	VDD_HPA	
8	-5 VDC	HPA gate Voltage
9	GND	
10	VDD_HPA_SENSE_RTN	Ground
11	PV_SEQ_READY	Voltage sequence ready indicator. Low (-3.5V): unit ready to apply VDD. High (0V): unit not read
12	BUC_HPA_I2C_SDA	I ² C temperature sensor
13	GND	
14	GND	
15	GND	
16	GND	
17	GND	
18	GND	
19	GND	
20	GND	
21	TEMP_SENSE	Unit temperature (analog)
22	VDD_HPA_SENSE	Positive voltage sensed at unit DC port
23	HPA_MUTE	Output stage amplifier pinch off. High (3.3V): HPA mute, Low (0V): HPA enable
24	GND	
25	BUC_HPA_I2C_SCL	I ² C temperature sensor

**KA-BAND BLOCK UPCONVERTER
With HPA**
Table 4. J2 BUC Connector Pin Out

Pin #	Signal/Voltage	Description
1	VDD_BUC	BUC positive voltage supply
2	VDD_BUC	
3	VDD_BUC	
4	21VDC	BUC positive voltage supply to PLLs
5	GND	
6	Input Frequency Select	Input Frequency Select: High (3.3V) Input Frequency Range: 1 - 2GHz Low (0V) Input Frequency Range: 0.95 - 1.95GHz
7	MDM_SELECT	Modem input selection. High (3.3V): internal modem, Low (0V): external modem
8	BUC_LO_LOCK	PLL lock indication. High (3.3V): unlocked, Low (0V): locked
9	TX_GAIN_CNTL_LE	Gain control signal latch enable
10	GND	
11	RESERVED FOR VENDOR USE: (RS232_RXD0)	
12	BUC_HPA_12C_SDA	I ² C bus data
13	GND	
14	GND	
15	GND	
16	GND	
17	-5VDC	BUC negative voltage supply
18	HPA_MUTE	
19	GND	
20	TX_BAND_SELECT	Transmitter band selection. Low (0V): commercial band 29-30GHz, High (3.3V): military band 30-31GHz
21	TX_GAIN_CNTL_SERIN	Gain control signal serial input
22	TX_GAIN_CNTL_CLK	Gain control signal clock
23	RESERVED FOR VENDOR USE: (RS232_RXD0)	
24	GND	
25	BUC_HPA_12C_SCL	I ² C bus clock

KA-BAND BLOCK UPCONVERTER With HPA

Outline Drawing

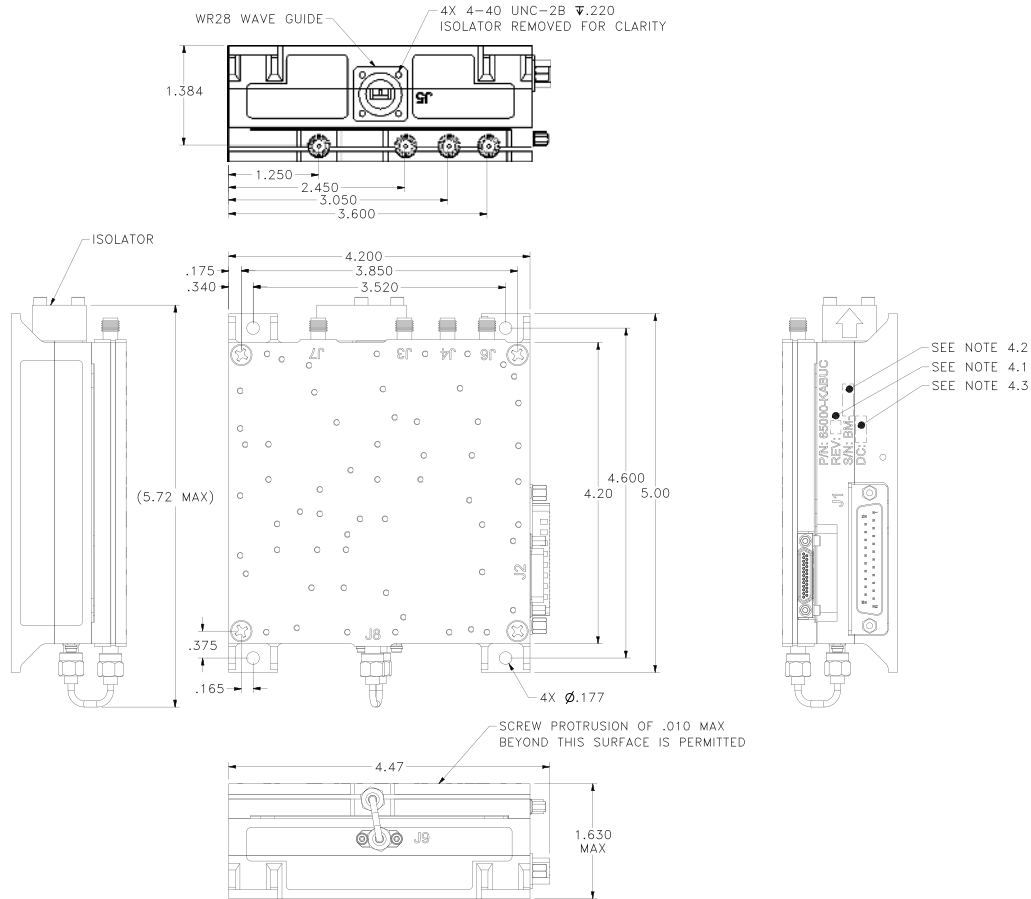

NOTES:

- 1.0 MATERIAL: ALUMINUM.
- 2.0 FINISH:
 - 2.1 POWER AMPLIFIER HOUSING: SILVER PER ASTM B700 OVER NICKEL PER MIL-C-26074.
 - 2.2 UPCONVERTER BASEPLATE AND COVER: CHEMICAL CONVERSION COAT PER MIL-DTL-5541, TYPE I, CLASS 3.
- 3.0 TOLERANCES:
 - 3.1 XX = \pm .02
 - 3.2 XXX = \pm .010
- 4.0 PRODUCT MARKING TO BE ENGRAVED, AND LOCATED APPROXIMATELY AS SHOWN.
 - 4.1 REVISION TO BE MARKED WITH LATEST REVISION OF 090-03588-00 ASSEMBLY.
 - 4.2 UNITS TO BE SERIALLY MARKED IN ACCORDANCE WITH PURCHASE CONTRACT WHERE "X" = SEQUENTIAL NUMBERS.
 - 4.3 DATE CODE MARKING TO SHOW DATE IN "MMYY" FORMAT.

Package Information

Size	Weight
5.72"x4.51"x1.63"	2.11 lbs