

APPROVED: _____

DATE: _____ TITLE: _____

Rev	AWO #	Description	Date	Appr
-		RELEASED	8/10/21	
A		UPDATE SPEC.	10/20/21	WX/RC
B		UPDATED DRAWING	6/15/22	JJ/MC
C		UPDATED COLOR	6/15/22	JJ/MC

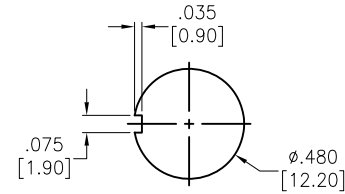
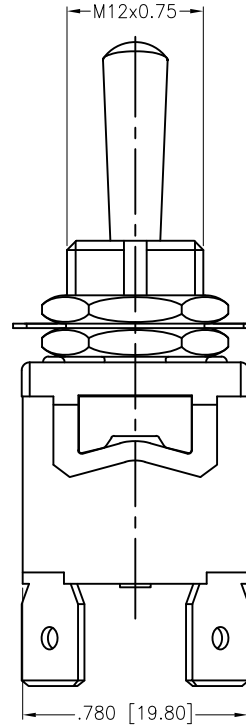
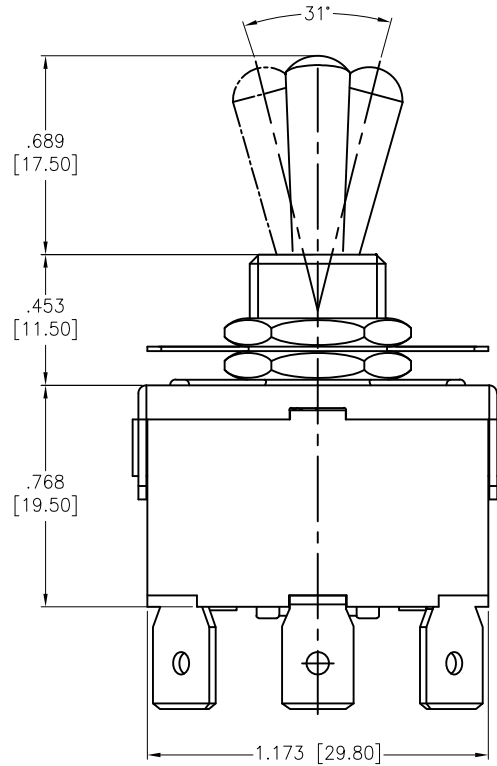

RECOMMENDED
PANEL CUT-OUT

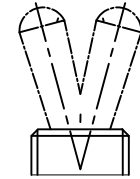

2 WAY

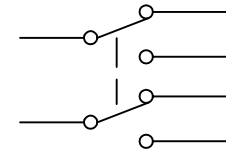

CIRCUIT DIAGRAM
(DPDT)

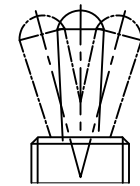

3 WAY

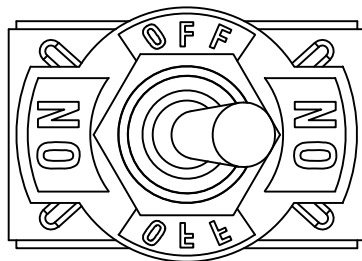

SW-T1-4X-B-K2A

- B=ON-ON
- D=ON-(ON)
- E=ON-OFF-ON
- F=ON-OFF-(ON)
- G=(ON)-OFF-(ON)

SPECIFICATIONS:

Material:
Body: Bakelite, Color: Red Brown
Lever: Brass, Nickel plated
Terminal: Brass, Silver plated

Electrical:
Rating: 6A @ 250V AC
10A @ 125V AC

Contact resistance: 50 mΩ max
Insulation resistance: 1000 MΩ min @ 500 VDC
Dielectric withstanding voltage: 1500V AC for 1 minute
Electrical Life: 10,000 cycles
Temperature Rating:

Operating temperature: -25°C to +85°C

Environmental:

Lead free, RoHS compliant



UNLESS OTHERWISE SPECIFIED ALL DIMENSIONS ARE INCHES [MM]. TOLERANCES: EXCEPT AS NOTED

INCHES		HOLES	
.X	± .10	∅X	± .10
.XX	± .020	∅XX	± .015
.XXX	± .015	∅XXX	± .010

DRAWN	WX	8/10/21
CHECKED	RC	8/10/21
APPROVED		

THIS DRAWING CONTAINS INFORMATION THAT IS PROPRIETARY AND SHOULD NOT BE USED WITHOUT PRIOR WRITTEN PERMISSION FROM ADAM TECH



909 Rahway Avenue,
Union, NJ 07083
Phone: 908-687-5000
Fax: 908-687-5710

TITLE SWITCH, TOGGLE MEDIUM, DPDT,
PC TERMINALS .250 [6.35mm]

SIZE X	PART NO. SW-T1-4X-B-K2A	REV. C
REF: S00206C	SCALE: NTS	SHEET 1 OF 1