

OSRAM LW Q38E

Datasheet

Published by **ams-OSRAM AG**

Tobelbader Strasse 30, 8141 Premstaetten, Austria

Phone +43 3136 500-0

ams-osram.com

© All rights reserved



Chip LED 0603

LW Q38E



Applications

- Access Control & Security
- Ambient Lighting
- Appliances & Tools
- Digital Diagnostic Devices
- Display Backlighting
- Factory Automation
- Home & Building Automation
- Material Processing
- Projection & Display
- Robotics
- Smart Surface
- Vital Sign Monitoring

Features

- Package: SMT package 0603, colored diffused resin
- Chip technology: InGaN on Sapphire
- Typ. Radiation: 150° (horizontal), 130° (vertical)
- Color: Cx = 0.3, Cy = 0.28 acc. to CIE 1931 (● white)
- Optical efficacy: 36 lm/W
- Corrosion Robustness Class: 3B
- ESD: 8 kV acc. to ANSI/ESDA/JEDEC JS-001 (HBM, Class 3B)

Ordering Information

Type	Luminous Intensity ¹⁾ $I_F = 5 \text{ mA}$ I_v	Ordering Code
LW Q38E-Q100-3K6L-1	$\geq 71 \text{ mcd}$	Q65110A7210
LW Q38E-Q200-3K5L	$\geq 90 \text{ mcd}$	Q65110A7939

Maximum Ratings

Parameter	Symbol		Values
Operating Temperature	T_{op}	min.	-40 °C
		max.	85 °C
Storage Temperature	T_{stg}	min.	-40 °C
		max.	85 °C
Junction Temperature	T_j	max.	95 °C
Forward current $T_A = 25\text{ °C}$	I_F	max.	15 mA
Surge Current $t \leq 10\text{ }\mu\text{s}$; $D = 0.005$; $T_A = 25\text{ °C}$	I_{FS}	max.	100 mA
ESD withstand voltage acc. to ANSI/ESDA/JEDEC JS-001 (HBM, Class 3B)	V_{ESD}		8 kV
Reverse current ²⁾	I_R	max.	20 mA

Characteristics

 $I_F = 5 \text{ mA}$; $T_A = 25 \text{ °C}$

Parameter	Symbol		Values
Chromaticity Coordinate ³⁾	C_x	typ.	0.3
	C_y	typ.	0.28
Viewing angle at 50% I_V values for 0°, 90°	2ϕ	typ.	150 °
		typ.	130 °
Forward Voltage ⁴⁾ $I_F = 5 \text{ mA}$	V_F	min.	2.60 V
		typ.	2.85 V
		max.	3.10 V
Reverse voltage (ESD device)	$V_{R\text{ESD}}$	min.	7 V
Reverse voltage ²⁾ $I_R = 20 \text{ mA}$	V_R	max.	1.2 V
Real thermal resistance junction/ambient ⁵⁾⁶⁾	$R_{\text{thJA real}}$	max.	650 K / W
Real thermal resistance junction/solderpoint ⁵⁾	$R_{\text{thJS real}}$	max.	370 K / W

Brightness Groups

Group	Luminous Intensity ¹⁾ $I_F = 5 \text{ mA}$ min. I_v	Luminous Intensity. ¹⁾ $I_F = 5 \text{ mA}$ max. I_v	Luminous Flux ⁷⁾ $I_F = 5 \text{ mA}$ typ. Φ_v
Q1	71 mcd	90 mcd	240 mlm
Q2	90 mcd	112 mcd	300 mlm
R1	112 mcd	140 mcd	380 mlm
R2	140 mcd	180 mcd	480 mlm
S1	180 mcd	224 mcd	610 mlm
S2	224 mcd	280 mcd	760 mlm
T1	280 mcd	355 mcd	950 mlm
T2	355 mcd	450 mcd	1210 mlm

Forward Voltage Groups

Group	Forward Voltage ⁴⁾ $I_F = 5 \text{ mA}$ min. V_F	Forward Voltage ⁴⁾ $I_F = 5 \text{ mA}$ max. V_F
3X	2.60 V	2.70 V
3Y	2.70 V	2.80 V
3Z	2.80 V	2.90 V
4X	2.90 V	3.00 V
4Y	3.00 V	3.10 V

Chromaticity Coordinate Groups

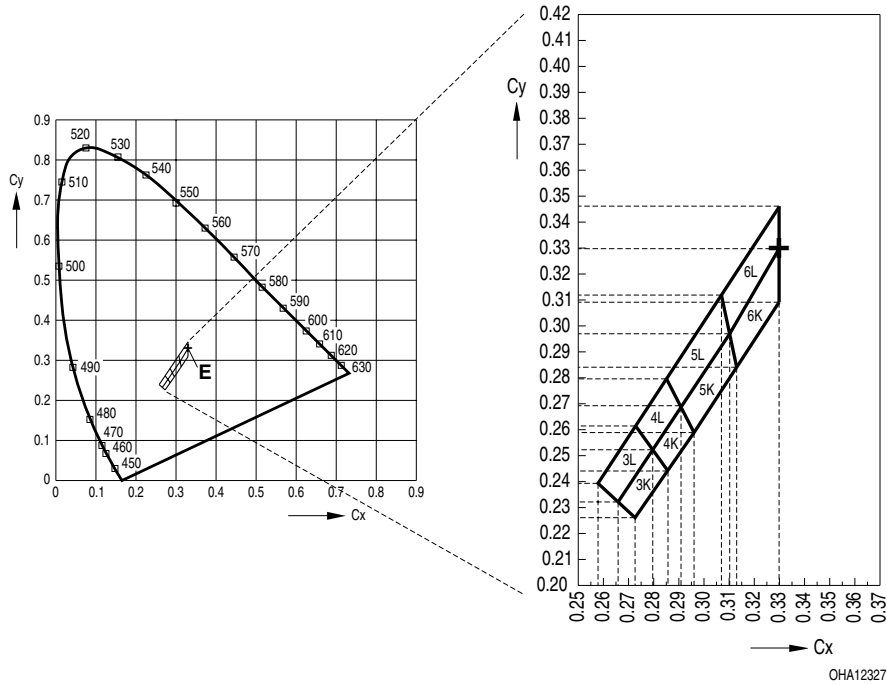

Chromaticity Coordinate Groups ³⁾

Group	Cx	Cy	Group	Cx	Cy	Group	Cx	Cy
3K	0.2730	0.2270	4L	0.2800	0.2520	6K	0.3130	0.2840
	0.2660	0.2320		0.2730	0.2610		0.3100	0.2970
	0.2800	0.2520		0.2850	0.2790		0.3300	0.3300
	0.2860	0.2440		0.2910	0.2680		0.3300	0.3100
3L	0.2660	0.2320	5K	0.2960	0.2590	6L	0.3100	0.2970
	0.2580	0.2390		0.2910	0.2680		0.3070	0.3120
	0.2730	0.2610		0.3100	0.2970		0.3300	0.3470
	0.2800	0.2520		0.3130	0.2840		0.3300	0.3300
4K	0.2860	0.2440	5L	0.2910	0.2680			
	0.2800	0.2520		0.2850	0.2790			
	0.2910	0.2680		0.3070	0.3120			
	0.2960	0.2590		0.3100	0.2970			

Group Name on Label

Example: Q1-3K-3X

Brightness

Color Chromaticity

Forward Voltage

Q1

3K

3X

Relative Spectral Emission ⁷⁾

$I_{rel} = f(\lambda); I_F = 5 \text{ mA}; T_A = 25 \text{ }^\circ\text{C}$

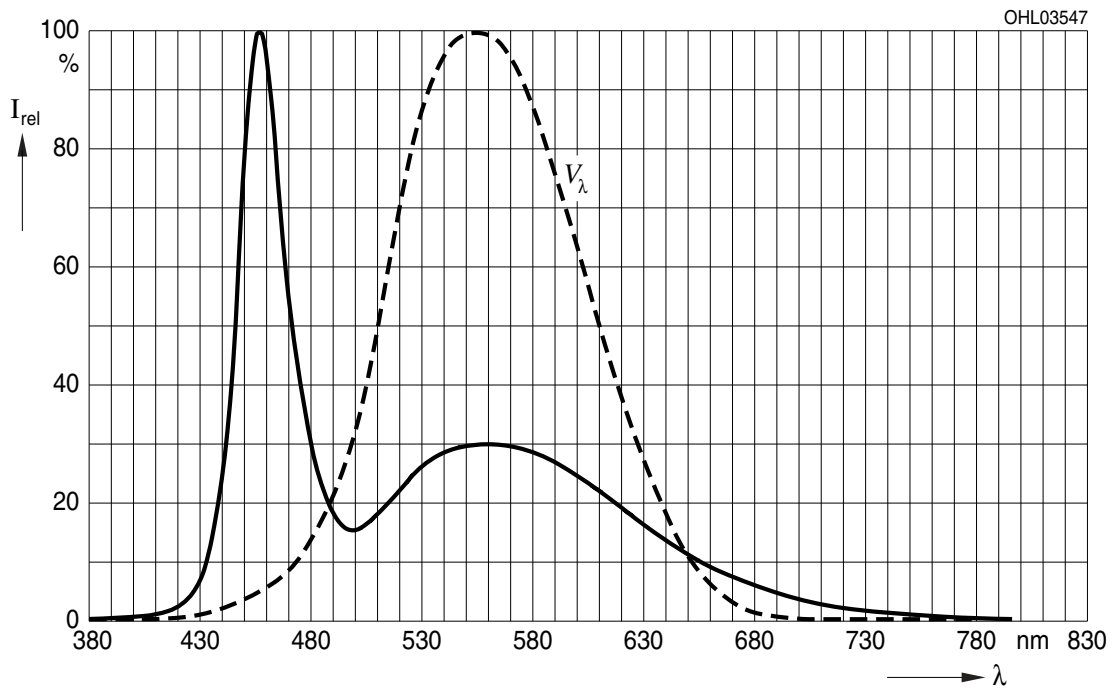

Radiation Characteristics ⁷⁾

$I_{rel} = f(\phi); T_A = 25 \text{ }^\circ\text{C}$

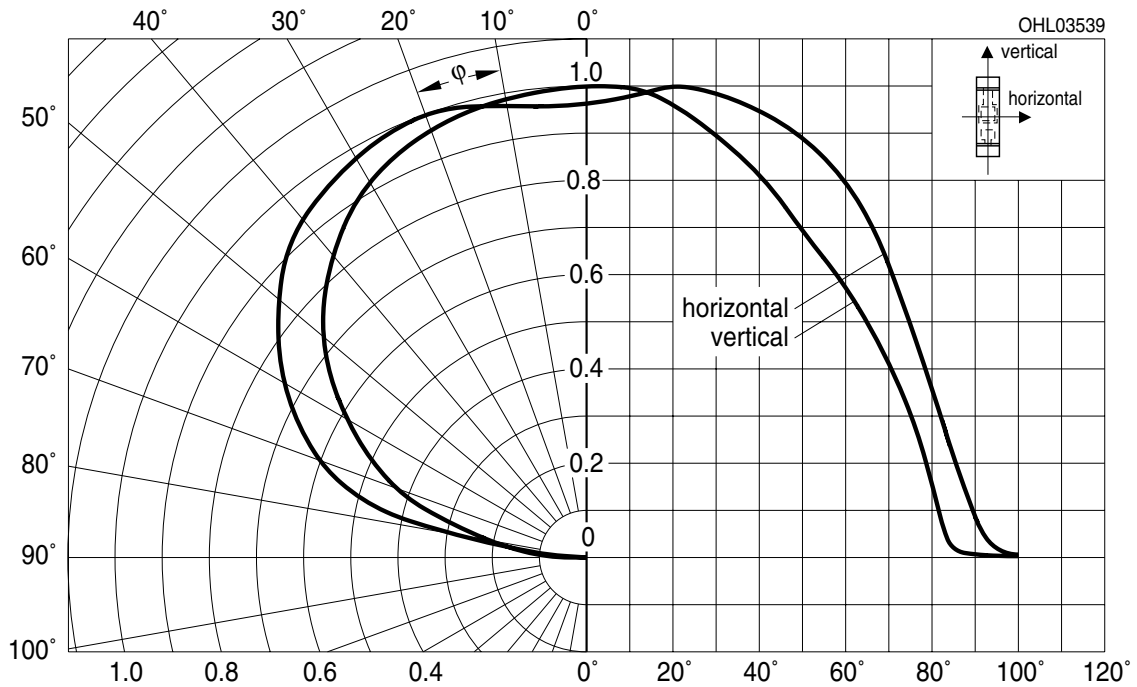

Forward current ^{7), 8)}

$$I_F = f(V_F); T_A = 25\text{ °C}$$

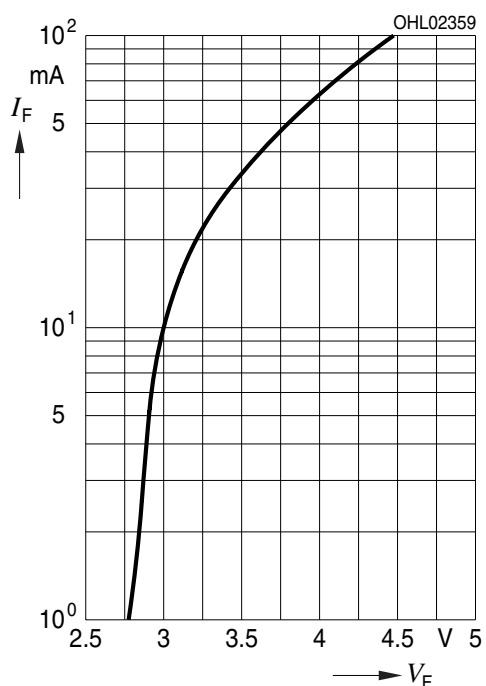

Relative Luminous Intensity ^{7), 8)}

$$I_V/I_V(5\text{ mA}) = f(I_F); T_A = 25\text{ °C}$$

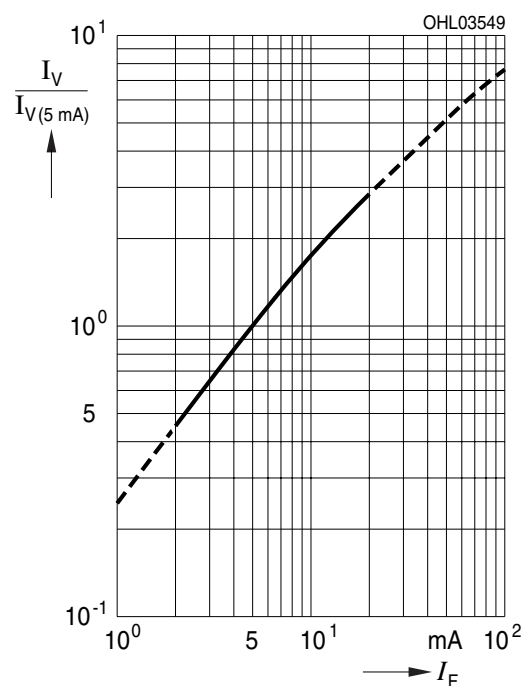

Chromaticity Coordinate Shift ⁷⁾

$$\Delta Cx, \Delta Cy = f(I_F); T_A = 25\text{ °C}$$

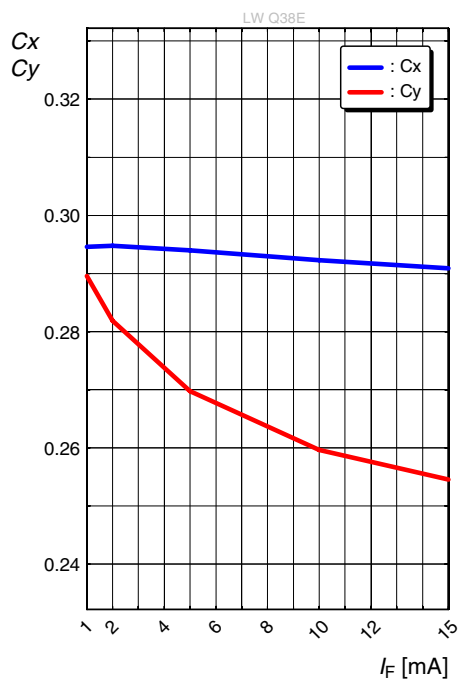

Forward Voltage ⁷⁾

$\Delta V_F = V_F - V_F(25\text{ }^\circ\text{C}) = f(T_j); I_F = 5\text{ mA}$

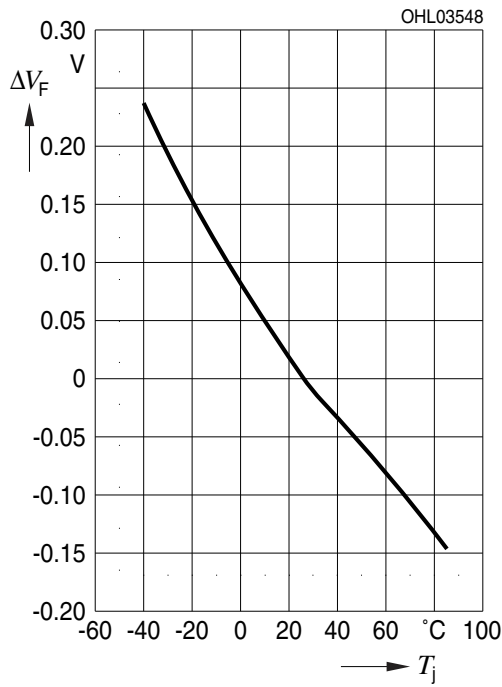

Relative Luminous Intensity ⁷⁾

$I_V/I_V(25\text{ }^\circ\text{C}) = f(T_j); I_F = 5\text{ mA}$

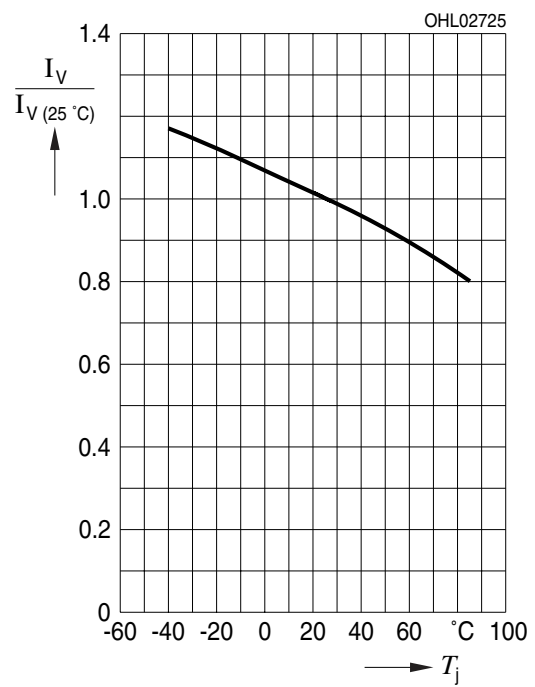

Chromaticity Coordinate Shift ⁷⁾

$\Delta C_x, \Delta C_y = f(T_j); I_F = 5\text{ mA}$

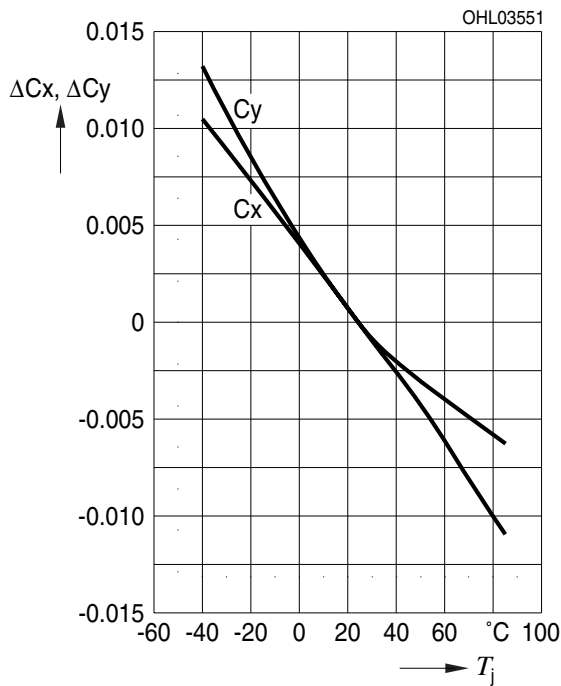

Max. Permissible Forward Current ⁵⁾

$I_F = f(T)$

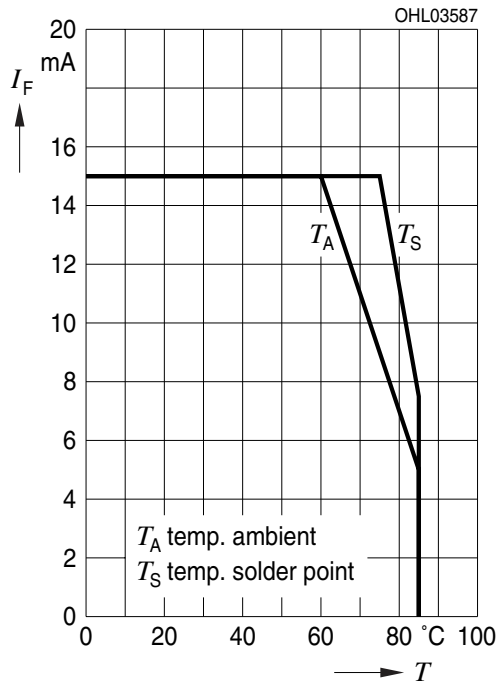

Permissible Pulse Handling Capability

$I_F = f(t_p)$; D: Duty cycle; $T_A = 25\text{ °C}$

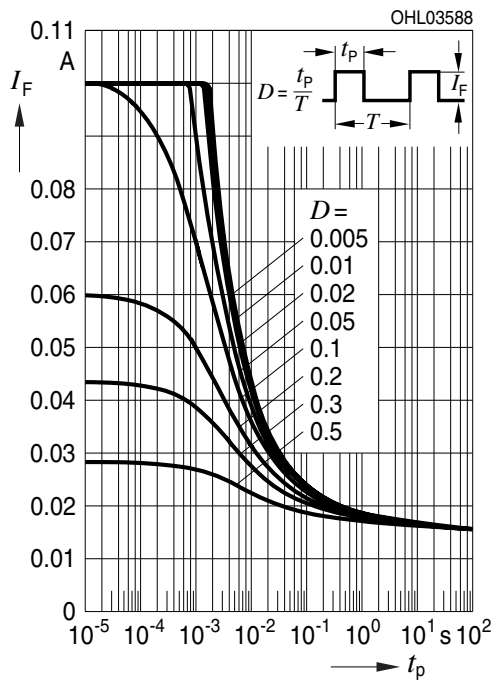

Permissible Pulse Handling Capability

$I_F = f(t_p)$; D: Duty cycle; $T_A = 85\text{ °C}$

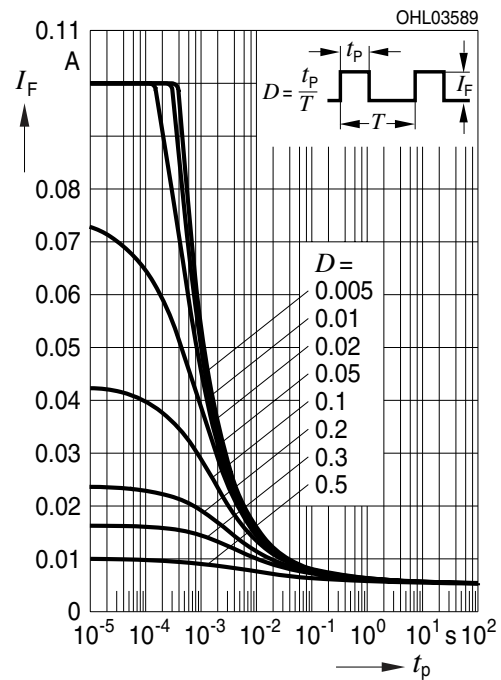

Dimensional Drawing ⁹⁾

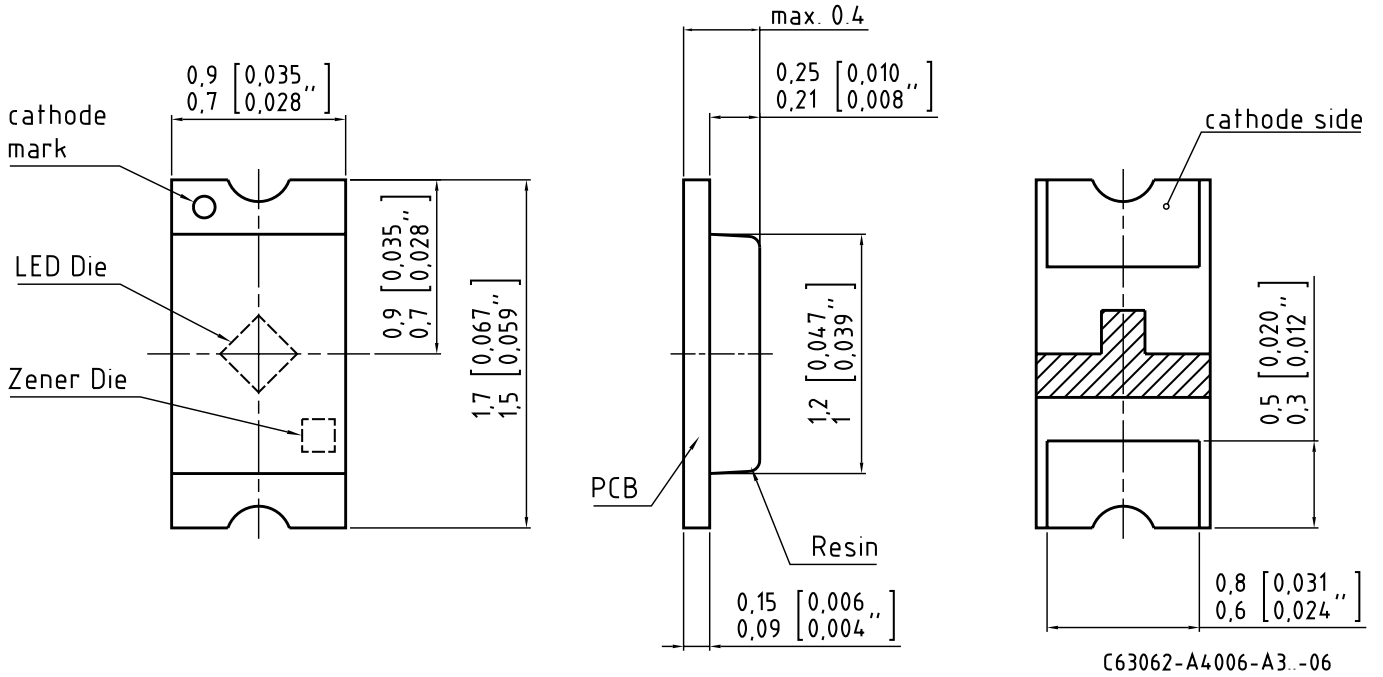

Further Information:

Approximate Weight: 1.0 mg

Corrosion test: Class: 3B
Test condition: 40°C / 90 % RH / 15 ppm H₂S / 14 days (stricter than IEC 60068-2-43)

ESD advice: The device is protected by ESD device which is connected in parallel to the Chip.

Recommended Solder Pad ⁹⁾

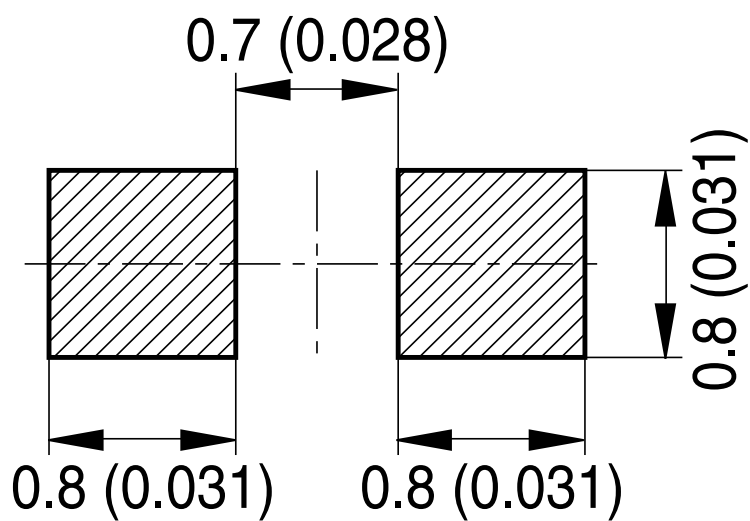

OHAPY606

For superior solder joint connectivity results we recommend soldering under standard nitrogen atmosphere. Package not suitable for ultra sonic cleaning.

Reflow Soldering Profile

Product complies to MSL Level 2 acc. to JEDEC J-STD-020E

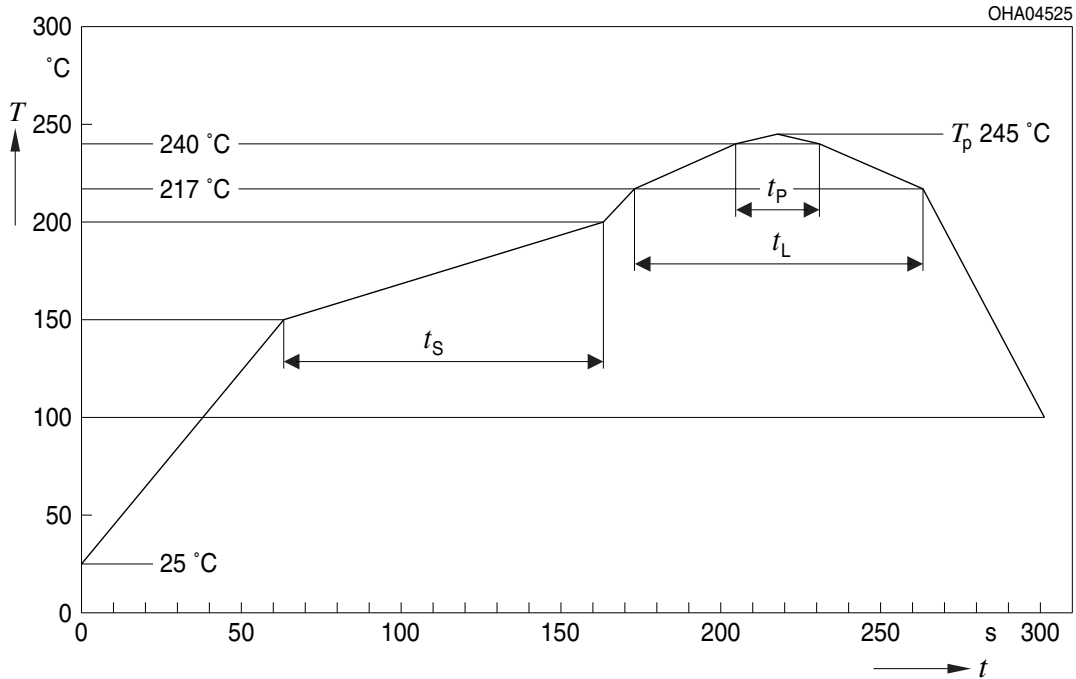

Profile Feature	Symbol	Pb-Free (SnAgCu) Assembly			Unit
		Minimum	Recommendation	Maximum	
Ramp-up rate to preheat ^{*)} 25 °C to 150 °C			2	3	K/s
Time t_s T_{Smin} to T_{Smax}	t_s	60	100	120	s
Ramp-up rate to peak ^{*)} T_{Smax} to T_p			2	3	K/s
Liquidus temperature	T_L		217		°C
Time above liquidus temperature	t_L		80	100	s
Peak temperature	T_p		245	260	°C
Time within 5 °C of the specified peak temperature $T_p - 5$ K	t_p	10	20	30	s
Ramp-down rate* T_p to 100 °C			3	6	K/s
Time 25 °C to T_p				480	s

All temperatures refer to the center of the package, measured on the top of the component

* slope calculation DT/Dt : Dt max. 5 s; fulfillment for the whole T-range

Taping ⁹⁾

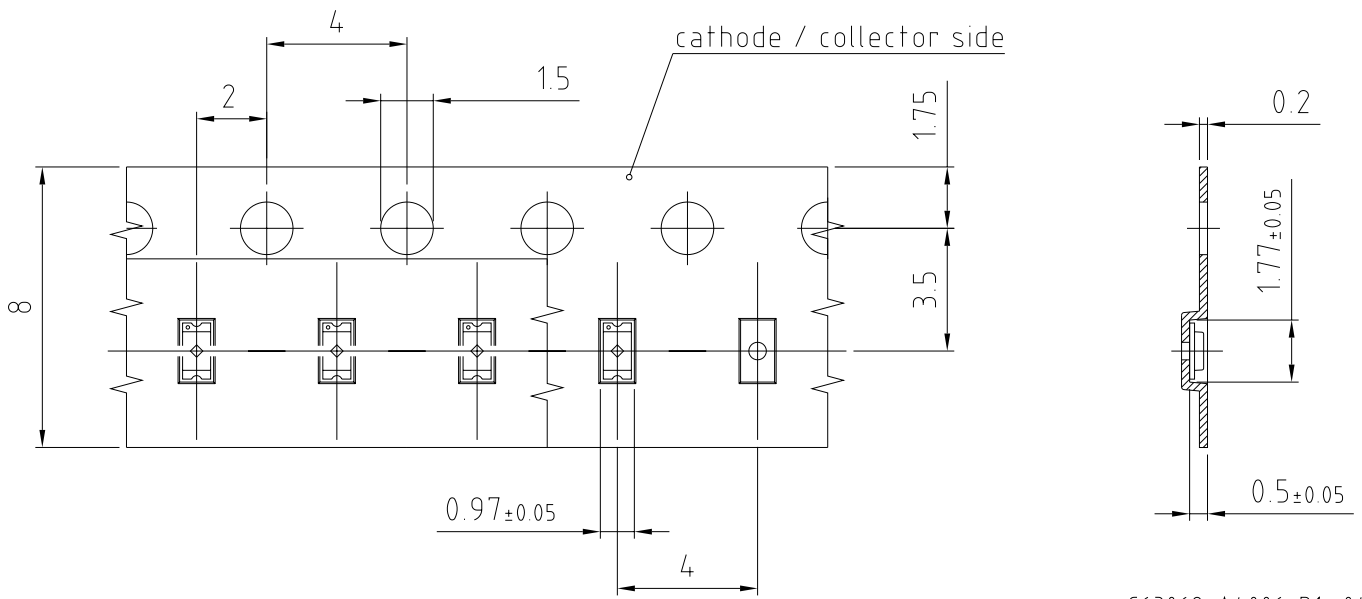

C63062-A4006-B1-04

Tape and Reel ¹⁰⁾

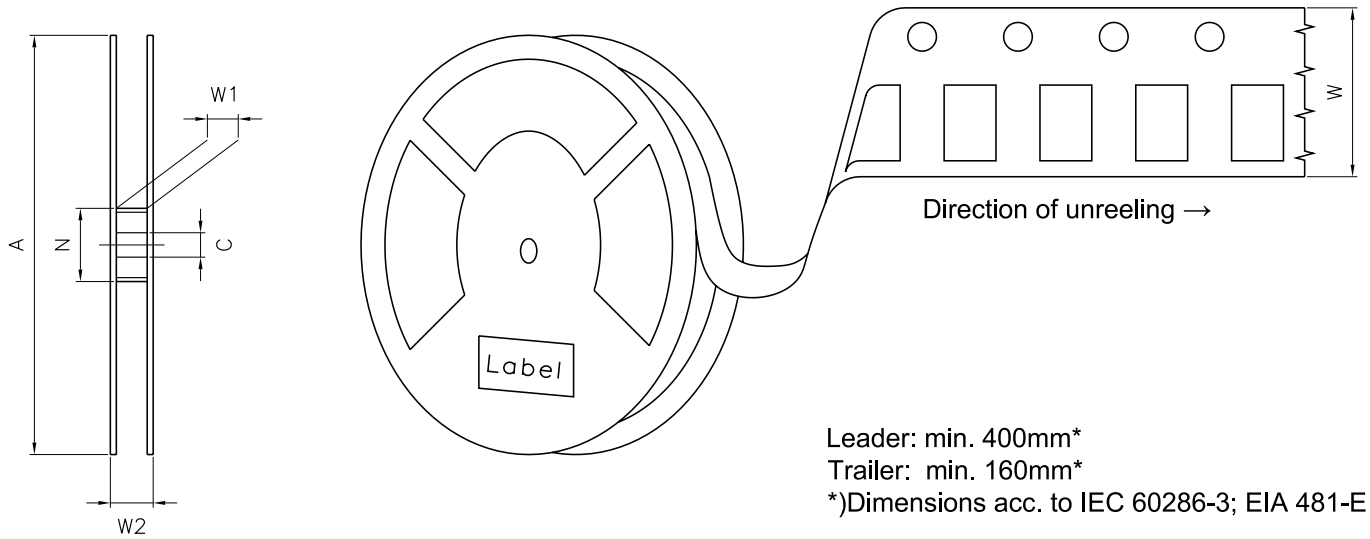

Reel Dimensions

A	W	N _{min}	W ₁	W _{2 max}	Pieces per PU
180 mm	8 + 0.3 / - 0.1 mm	60 mm	8.4 + 2 mm	14.4 mm	4000

Barcode-Product-Label (BPL)

OSRAM LX XXXX BIN1: XX-XX-X-XXX-X





RoHS Compliant

(6P) BATCH NO: 1234567890 ML Temp ST
X XXX °C X

(1T) LOT NO: 1234567890 (9D) D/C: 1234

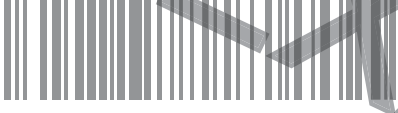
Pack: RXX
DEMY XXX
X_X123_1234.1234 X

(X) PROD NO: 123456789(Q)QTY: 9999 (G) GROUP: XX-XX-X-X

OHA04563

Dry Packing Process and Materials ⁹⁾

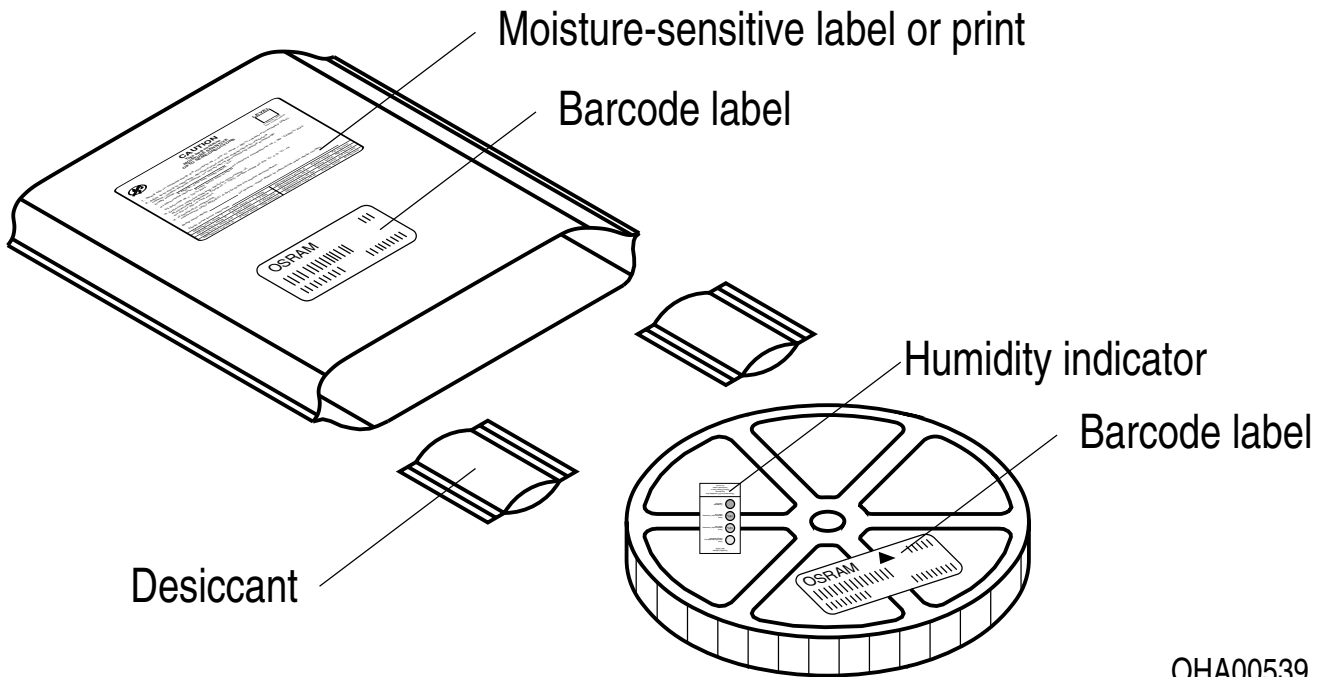

OHA00539

Moisture-sensitive product is packed in a dry bag containing desiccant and a humidity card according JEDEC-STD-033.

Schematic Transportation Box ⁹⁾

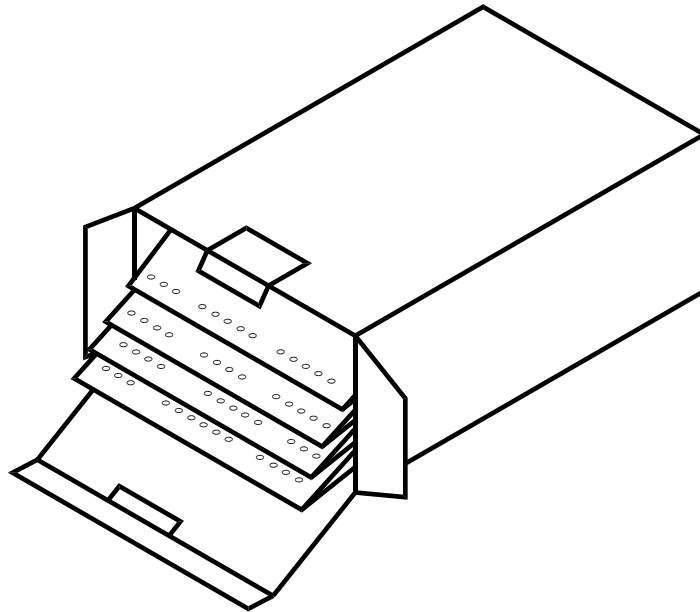

C63062-A3437-X121-01

Dimensions of Transportation Box

Width	Length	Height
260 ± 5 mm	230 ± 5 mm	85 ± 5 mm

Type Designation System

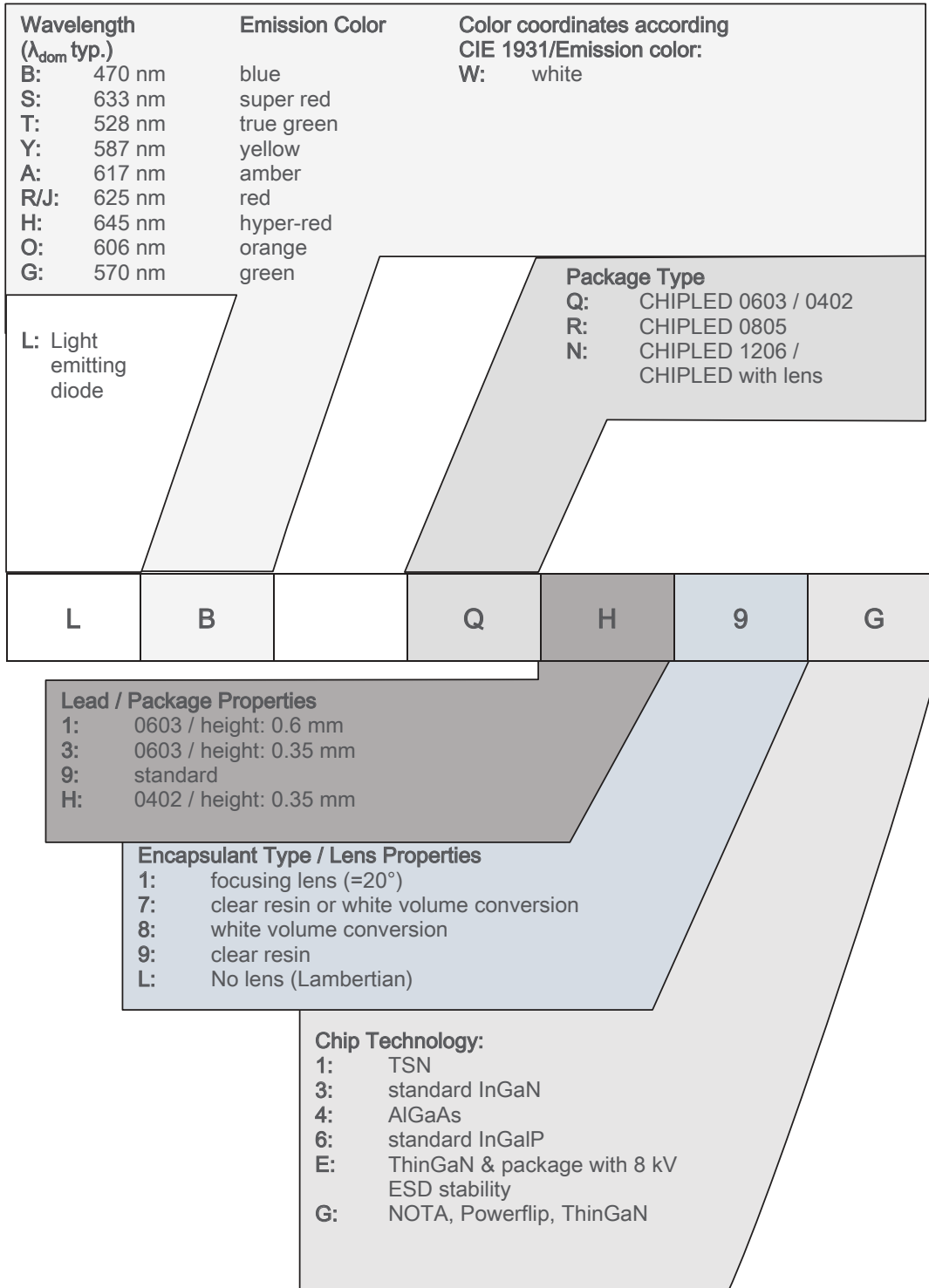

Notes

The evaluation of eye safety occurs according to the standard IEC 62471:2006 (photo biological safety of lamps and lamp systems). Within the risk grouping system of this IEC standard, the device specified in this data sheet fall into the class **exempt group (exposure time 10000 s)**. Under real circumstances (for exposure time, conditions of the eye pupils, observation distance), it is assumed that no endangerment to the eye exists from these devices. As a matter of principle, however, it should be mentioned that intense light sources have a high secondary exposure potential due to their blinding effect. When looking at bright light sources (e.g. headlights), temporary reduction in visual acuity and afterimages can occur, leading to irritation, annoyance, visual impairment, and even accidents, depending on the situation.

Subcomponents of this device contain, in addition to other substances, metal filled materials including silver. Metal filled materials can be affected by environments that contain traces of aggressive substances. Therefore, we recommend that customers minimize device exposure to aggressive substances during storage, production, and use. Devices that showed visible discoloration when tested using the described tests above did show no performance deviations within failure limits during the stated test duration. Respective failure limits are described in the IEC60810.

Based on very short life cycle times in chip technology this component is subject to frequent adaption to the latest chip technology.

For further application related information please visit www.osram-os.com/appnotes

Disclaimer

Attention please!

The information describes the type of component and shall not be considered as assured characteristics. Terms of delivery and rights to change design reserved. Due to technical requirements components may contain dangerous substances.

For information on the types in question please contact our Sales Organization.

If printed or downloaded, please find the latest version on our website.

Packing

Please use the recycling operators known to you. We can also help you – get in touch with your nearest sales office. By agreement we will take packing material back, if it is sorted. You must bear the costs of transport. For packing material that is returned to us unsorted or which we are not obliged to accept, we shall have to invoice you for any costs incurred.

Product and functional safety devices/applications or medical devices/applications

Our components are not developed, constructed or tested for the application as safety relevant component or for the application in medical devices.

Our products are not qualified at module and system level for such application.

In case buyer – or customer supplied by buyer – considers using our components in product safety devices/ applications or medical devices/applications, buyer and/or customer has to inform our local sales partner immediately and we and buyer and /or customer will analyze and coordinate the customer-specific request between us and buyer and/or customer.

Glossary

- 1) **Brightness:** Brightness groups are tested at a current pulse duration of 25 ms and a tolerance of $\pm 11\%$.
- 2) **Reverse Operation:** This product is intended to be operated applying a forward current within the specified range. Applying any continuous reverse bias or forward bias below the voltage range of light emission shall be avoided because it may cause migration which can change the electro-optical characteristics or damage the LED.
- 3) **Chromaticity coordinate groups:** Chromaticity coordinate groups are tested at a current pulse duration of 25 ms and a tolerance of ± 0.01 .
- 4) **Forward Voltage:** Forward voltages are tested at a current pulse duration of 1 ms and a tolerance of ± 0.1 V.
- 5) **Thermal Resistance:** $R_{th\ max}$ is based on statistic values (6σ) used for Derating.
- 6) **Thermal Resistance:** R_{thJA} results from mounting on PC board FR 4 (pad size $\geq 5\text{ mm}^2$ per pad)
- 7) **Typical Values:** Due to the special conditions of the manufacturing processes of semiconductor devices, the typical data or calculated correlations of technical parameters can only reflect statistical figures. These do not necessarily correspond to the actual parameters of each single product, which could differ from the typical data and calculated correlations or the typical characteristic line. If requested, e.g. because of technical improvements, these typ. data will be changed without any further notice.
- 8) **Characteristic curve:** In the range where the line of the graph is broken, you must expect higher differences between single devices within one packing unit.
- 9) **Tolerance of Measure:** Unless otherwise noted in drawing, tolerances are specified with ± 0.1 and dimensions are specified in mm.
- 10) **Tape and Reel:** All dimensions and tolerances are specified acc. IEC 60286-3 and specified in mm.

Revision History

Version	Date	Change
1.4	2019-05-28	Maximum Ratings Characteristics
1.5	2019-10-24	Dimensional Drawing
1.6	2020-02-11	Taping
1.7	2021-09-28	Brand
1.8	2022-06-02	New Layout
1.9	2023-05-09	Characteristics Maximum Ratings



EU RoHS and China RoHS compliant product

此产品符合欧盟 RoHS 指令的要求；
按照中国的相关法规和标准，
不含有毒有害物质或元素。

Published by ams-OSRAM AG

Tobelbader Strasse 30, 8141 Premstaetten, Austria

Phone +43 3136 500-0

ams-osram.com

© All rights reserved

am 

OSRAM