

General information

Part number	S11MCC-P12MCC9-6550
Termination	solder
Size	1
Locking principle	push
Coding	c_key_medi
Cable Diameter	cable_medi_65
Cable outlet	standard

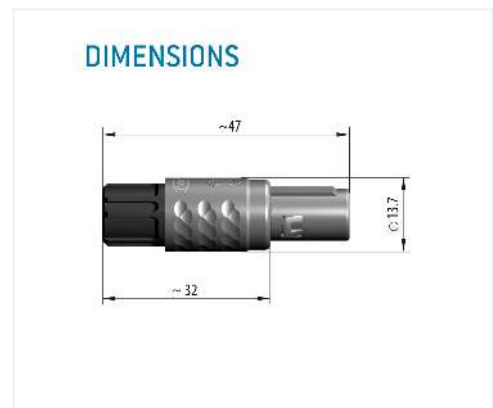

Contact insert description

Number of contacts	12
Contact type	pins
Contact diameter	05mm
Insulator material	peek
Wire cross section	28_awg
Termination	solder
Termination diameter	045mm

reverse_gender_on_request

Technical information

Max. creepage and air clearance distance	05_mm	
Nominal current single contact	04_a	iec_60512_5_2
Nominal current insert	2,2 A	vde_0298_4
Test voltage	12_kv_dc	sae_13441

safety_text

Mechanical and environmental data

Degree of protection*	ip50
-----------------------	------

Operating temperature	50_120_c
-----------------------	----------

Mating cycles	2000
---------------	------

mated_unmated

Material and surface treatments

Housing	m_chrome
---------	----------

Color option	green
--------------	-------

Contact	cu_alloy_gold
---------	---------------

safety_text_2

ul_text

illustrative_text