

Features

- Analog Signal Range ($\pm 15V$ Supplies) $\pm 15V$
- Low Leakage (Typical at $+25^\circ C$) 40pA
- Low Leakage (Typical at $+125^\circ C$) 1nA
- Low On Resistance (Typical at $+25^\circ C$) 35 Ω
- Break-Before-Make Delay (Typical) 60ns
- Charge Injection 30pC
- TTL, CMOS Compatible
- Symmetrical Switch Elements
- Low Operating Power 1.0mW (Typical for HI-300 - 303)

Applications

- Sample and Hold (i.e. Low Leakage Switching)
- Op Amp Gain Switching (i.e. Low On Resistance)
- Portable, Battery Operated Circuits
- Low Level Switching Circuits
- Dual or Single Supply Systems

Description

The HI-300 thru HI-307 series of switches are monolithic devices fabricated using CMOS technology and the Harris dielectric isolation process. These switches feature break-before-make switching, (HI-301, HI-303, HI-305 and HI-307 only), low and nearly constant ON resistance over the full analog signal range, and low power dissipation, (a few mW for the HI-300 thru HI-303, a few hundred mW for the HI-304 thru HI-307).

The HI-300 thru HI-303 are TTL compatible and have a logic "0" condition with an input less than 0.8V and a logic "1" condition with an input greater than 4.0V. The HI-304 thru HI-307 switches are CMOS compatible and have a low state with an input less than 3.5V and a high state with an input greater than 11V. (See pinouts for switch conditions with a logic "1" input.)

All the devices are available in a 14 lead Epoxy or Ceramic DIP. The HI-300, HI-301, HI-304 and HI-305 are also available in a 10 pin Metal Can. Each of the switch types are available in either the $-55^\circ C$ to $+125^\circ C$ or $0^\circ C$ to $+75^\circ C$ operating ranges.

Pinouts (Switch States are for a Logic "1" Input)

DUAL SPST HI-300 AND HI-304
TOP VIEWS

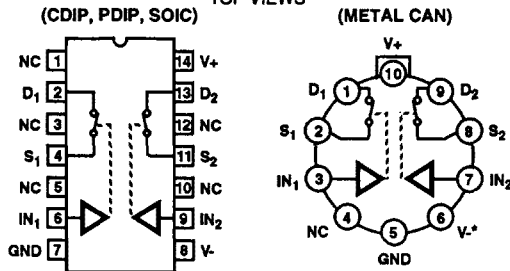

LOGIC	SWITCH
0	OFF
1	ON

* The substrate and case are internally tied to V-. (The case should not be used as the V- connection, however.)

SPST HI-301 AND HI-305
TOP VIEWS

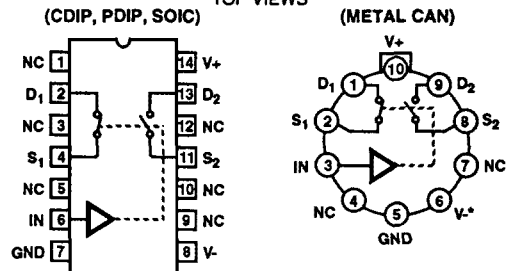

LOGIC	SW1	SW2
0	OFF	ON
1	ON	OFF

* The substrate and case are internally tied to V-. (The case should not be used as the V- connection, however.)

DUAL DPST HI-302 AND HI-306 (PDIP, CDIP, SOIC)
TOP VIEW

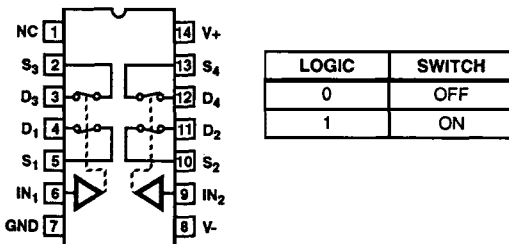

LOGIC	SWITCH
0	OFF
1	ON

DUAL SPDT HI-303 AND HI-307 (PDIP, CDIP, SOIC)
TOP VIEW

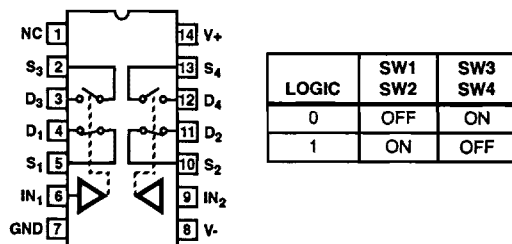

LOGIC	SW1	SW2	SW3	SW4
0	OFF	OFF	ON	ON
1	ON	ON	OFF	OFF

HI-300 thru HI-307

Ordering Information

PART NUMBER	TEMPERATURE RANGE	PACKAGE
HI1-0300-2	-55°C to +125°C	14 Lead Ceramic DIP
HI1-0300-5	0°C to +75°C	14 Lead Ceramic DIP
HI2-0300-2	-55°C to +125°C	10 Pin TO-5 Can
HI2-0300-5	0°C to +75°C	10 Pin TO-5 Can
HI3-0300-5	0°C to +75°C	14 Lead Plastic DIP
HI9P0300-5	0°C to +75°C	14 Lead SOIC
HI9P0300-9	-40°C to +85°C	14 Lead SOIC
HI1-0301-2	-55°C to +125°C	14 Lead Ceramic DIP
HI1-0301-5	0°C to +75°C	14 Lead Ceramic DIP
HI2-0301-2	-55°C to +125°C	10 Pin TO-5 Can
HI2-0301-5	0°C to +75°C	10 Pin TO-5 Can
HI3-0301-5	0°C to +75°C	14 Lead Plastic DIP
HI9P0301-5	0°C to +75°C	14 Lead SOIC
HI9P0301-9	-40°C to +85°C	14 Lead SOIC
HI1-0302-2	-55°C to +125°C	14 Lead Ceramic DIP
HI1-0302-5	0°C to +75°C	14 Lead Ceramic DIP
HI3-0302-5	0°C to +75°C	14 Lead Plastic DIP
HI9P0302-5	0°C to +75°C	14 Lead SOIC
HI9P0302-9	-40°C to +85°C	14 Lead SOIC
HI1-0303-2	-55°C to +125°C	14 Lead Ceramic DIP
HI1-0303-5	0°C to +75°C	14 Lead Ceramic DIP
HI3-0303-5	0°C to +75°C	14 Lead Plastic DIP
HI9P0303-5	0°C to +75°C	14 Lead SOIC
HI9P0303-9	-40°C to +85°C	14 Lead SOIC

PART NUMBER	TEMPERATURE RANGE	PACKAGE
HI1-0304-2	-55°C to +125°C	14 Lead Ceramic DIP
HI1-0304-5	0°C to +75°C	14 Lead Ceramic DIP
HI2-0304-2	-55°C to +125°C	10 Pin TO-5 Can
HI2-0304-5	0°C to +75°C	10 Pin TO-5 Can
HI3-0304-5	0°C to +75°C	14 Lead Plastic DIP
HI9P0304-5	0°C to +75°C	14 Lead SOIC
HI9P0304-9	-40°C to +85°C	14 Lead SOIC
HI1-0305-2	-55°C to +125°C	14 Lead Ceramic DIP
HI1-0305-5	0°C to +75°C	14 Lead Ceramic DIP
HI2-0305-2	-55°C to +125°C	10 Pin TO-5 Can
HI2-0305-5	0°C to +75°C	10 Pin TO-5 Can
HI3-0305-5	0°C to +75°C	14 Lead Plastic DIP
HI9P0305-5	0°C to +75°C	14 Lead SOIC
HI9P0305-9	-40°C to +85°C	14 Lead SOIC
HI1-0306-2	-55°C to +125°C	14 Lead Ceramic DIP
HI1-0306-5	0°C to +75°C	14 Lead Ceramic DIP
HI3-0306-5	0°C to +75°C	14 Lead Plastic DIP
HI9P0306-5	0°C to +75°C	14 Lead SOIC
HI9P0306-9	-40°C to +85°C	14 Lead SOIC
HI1-0307-2	-55°C to +125°C	14 Lead Ceramic DIP
HI1-0307-5	0°C to +75°C	14 Lead Ceramic DIP
HI3-0307-5	0°C to +75°C	14 Lead Plastic DIP
HI9P0307-5	0°C to +75°C	14 Lead SOIC
HI9P0307-9	-40°C to +85°C	14 Lead SOIC

Functional Block Diagram

TYPICAL SWITCH HI-300 SERIES

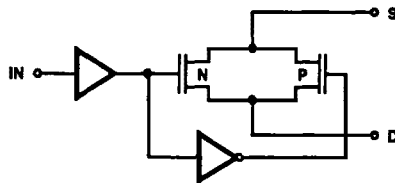

Schematic Diagrams

SWITCH CELL

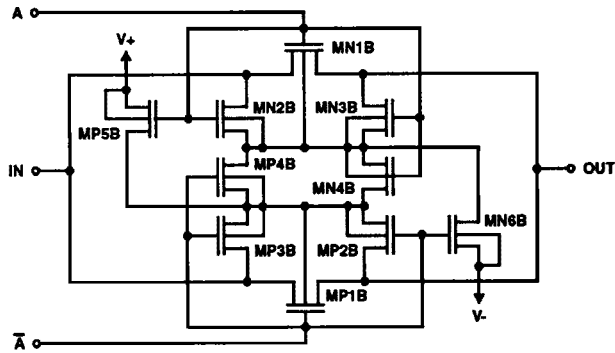

DIGITAL INPUT BUFFER AND LEVEL SHIFTER

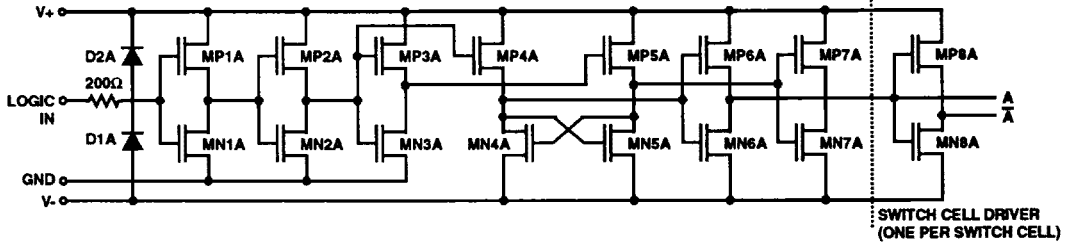

Specifications HI-300 thru HI-307

Absolute Maximum Ratings

Voltage Between Supplies	44V (±22V)
Digital Input Voltage	+V _{SUPPLY} +4V -V _{SUPPLY} -4V
Analog Input Voltage	+V _{SUPPLY} +1.5V -V _{SUPPLY} -1.5V
Storage Temperature Range	-65°C to +150°C
Lead Temperature (Soldering 10s)	+300°C
Typical Derating Factor	1.5mA/MHz Increase in ICCOP
ESD Classification	Class 1

Thermal Information

Thermal Resistance	θ_{JA}	θ_{JC}
14 Lead Ceramic DIP	95°C/W	24°C/W
14 Lead Plastic DIP	100°C/W	-
14 Lead SOIC	120°C/W	-
10 Pin TO-100 Metal Can	136°C/W	65°C/W
Maximum Power Dissipation		
Ceramic DIP	588mW	
Plastic DIP	526mW	
Metal Can	435mW	
Derate 6.9mW/0°C above T _A = +70°C		
Operating Temperature Range		
HI-3XX-2	-55°C to +125°C	
HI-3XX-5	0°C to +75°C	
Junction Temperature		
Ceramic DIP, TO-Can	+175°C	
Plastic DIP, SOIC	+150°C	

CAUTION: Stresses above those listed in "Absolute Maximum Ratings" may cause permanent damage to the device. This is a stress only rating and operation of the device at these or any other conditions above those indicated in the operational sections of this specification is not implied.

Electrical Specifications Supplies = +15V, -15V; V_{IN} = Logic Input. HI-300-303: V_{IN} - for Logic "1" = 4V, for Logic "0" = 0.8V.
HI-304-307: V_{IN} - for Logic "1" = 11V, for Logic "0" = 3.5V, Unless Otherwise Specified.

PARAMETERS	TEMP	-55°C TO +125°C			0°C TO +75°C			UNITS
		MIN	TYP	MAX	MIN	TYP	MAX	
SWITCHING CHARACTERISTICS								
Break-Before-Make Delay, t _{OPEN} (Note 15)	+25°C	-	60	-	-	60	-	ns
Switch On Time, t _{ON} (Note 13)	+25°C	-	210	300	-	210	300	ns
Switch Off Time, t _{OFF} (Note 13)	+25°C	-	160	250	-	160	250	ns
Switch Off Time, t _{ON} (Note 14)	+25°C	-	160	250	-	160	250	ns
Switch Off Time, t _{OFF} (Note 14)	+25°C	-	100	150	-	100	150	ns
"Off Isolation" (Note 6)	+25°C	-	60	-	-	60	-	dB
Charge Injection (Note 7)	+25°C	-	3	-	-	3	-	mV
Input Switch Capacitance, C _{S(OFF)}	+25°C	-	16	-	-	16	-	pF
Output Switch Capacitance, C _{D(OFF)}	+25°C	-	14	-	-	14	-	pF
Output Switch Capacitance, C _{D(ON)}	+25°C	-	35	-	-	35	-	pF
(High) Digital Input Capacitance, C _{IN}	+25°C	-	5	-	-	5	-	pF
(Low) Digital Input Capacitance, C _{IN}	+25°C	-	5	-	-	5	-	pF
DIGITAL INPUT CHARACTERISTICS								
Input Low Level, V _{INL} (Note 13)	Full	-	-	0.8	-	-	0.8	V
Input High Level, V _{INH} (Note 13)	Full	4	-	-	4	-	-	V
Input Low Level, V _{INL} (Note 14)	Full	-	-	3.5	-	-	3.5	V
Input High Level, V _{INH} (Note 14)	Full	11	-	-	11	-	-	V
Input Leakage Current (Low), I _{INL} (Note 5)	Full	-	-	1	-	-	1	µA
Input Leakage Current (High), I _{INH} (Note 5)	Full	-	-	1	-	-	1	µA
ANALOG SWITCH CHARACTERISTICS								
Analog Signal Range	Full	-15	-	+15	-15	-	+15	V
On Resistance, R _{ON} (Note 2)	+25°C	-	35	50	-	35	50	Ω
	Full	-	40	75	-	40	75	Ω
Off Input Leakage Current, I _{S(OFF)} (Note 3)	+25°C	-	0.04	1	-	0.04	5	nA
	Full	-	1	100	-	0.2	100	nA

Specifications HI-300 thru HI-307

Electrical Specifications Supplies = +15V, -15V; V_{IN} = Logic Input. HI-300-303: V_{IN} - for Logic "1" = 4V, for Logic "0" = 0.8V.
 HI-304-307: V_{IN} - for Logic "1" = 11V, for Logic "0" = 3.5V, Unless Otherwise Specified. (Continued)

PARAMETERS	TEMP	-55°C TO +125°C			0°C TO +75°C			UNITS
		MIN	TYP	MAX	MIN	TYP	MAX	
Off Output Leakage Current, $I_{D(OFF)}$ (Note 3)	+25°C	-	0.04	1	-	0.04	5	nA
	Full	-	1	100	-	0.2	100	nA
On Leakage Current, $I_{D(ON)}$ (Note 4)	+25°C	-	0.03	1	-	0.03	5	nA
	Full	-	0.5	100	-	0.2	100	nA
POWER SUPPLY CHARACTERISTICS								
Current, I+ (Notes 8, 13)	+25°C	-	0.09	0.5	-	0.09	0.5	mA
	Full	-	-	1	-	-	1	mA
Current, I- (Notes 8, 13)	+25°C	-	0.01	10	-	0.01	100	μA
	Full	-	-	100	-	-	-	μA
Current, I+ (Notes 9, 13)	+25°C	-	0.01	10	-	0.01	100	μA
	Full	-	-	100	-	-	-	μA
Current, I- (Notes 9, 13)	+25°C	-	0.01	10	-	0.01	100	μA
	Full	-	-	100	-	-	-	μA
Current, I+ (Notes 10, 14)	+25°C	-	0.01	10	-	0.01	100	μA
	Full	-	-	100	-	-	-	μA
Current, I- (Notes 10, 14)	+25°C	-	0.01	10	-	0.01	100	μA
	Full	-	-	100	-	-	-	μA
Current, I+ (Notes 11, 14)	+25°C	-	0.01	10	-	0.01	100	μA
	Full	-	-	100	-	-	-	μA
Current, I- (Notes 11, 14)	+25°C	-	0.01	10	-	0.01	100	μA
	Full	-	-	100	-	-	-	μA

NOTES:

1. As with all semiconductors, stresses listed under "Absolute Maximum Ratings" may be applied to devices (one at a time) without resulting in permanent damage. This is a stress rating only. Exposure to absolute maximum rating conditions for extended periods may affect device reliability. The conditions listed under "Electrical Specifications" are the only conditions recommended for satisfactory operation.
2. $V_S = \pm 10V$, $I_{OUT} = \mp 10mA$. On resistance derived from the voltage measured across the switch under the above conditions.
3. $V_S = \pm 14V$, $V_D = \mp 14V$.
4. $V_S = V_D = \pm 14V$.
5. The digital inputs are diode protected MOS gates and typical leakages of 1nA or less can be expected.
6. $V_S = 1V_{RMS}$, $f = 500kHz$, $C_L = 15pF$, $R_L = 1K$.
7. $V_S = 0V$, $C_L = 10,000pF$, Logic Drive = 5V pulse. (HI-300 - 303) Switches are symmetrical; S and D may be interchanged. Logic Drive = 15V (HI-304 - 307).
8. $V_{IN} = 4V$ (one input) (all other inputs = 0V).
9. $V_{IN} = 0.8V$ (all inputs).
10. $V_{IN} = 15V$ (all inputs).
11. $V_{IN} = 0V$ (all inputs).
12. To drive from DTL/TTL circuits, pullup resistors to +5V supply are recommended.
13. HI-300 thru HI-303 only.
14. HI-304 thru HI-307 only.
15. HI-301, HI-303, HI-305, HI-307 only.

Typical Performance Curves

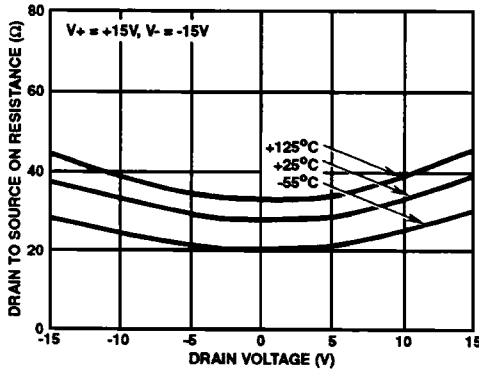

FIGURE 1. $R_{DS(ON)}$ vs V_D AND TEMPERATURE

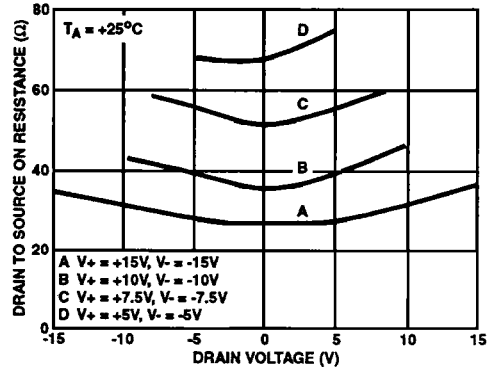

FIGURE 2. $R_{DS(ON)}$ vs V_D AND POWER SUPPLY VOLTAGE

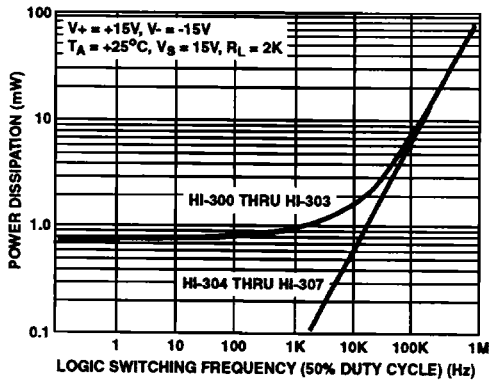

FIGURE 3. DEVICE POWER DISSIPATION vs SWITCHING FREQUENCY SINGLE LOGIC INPUT

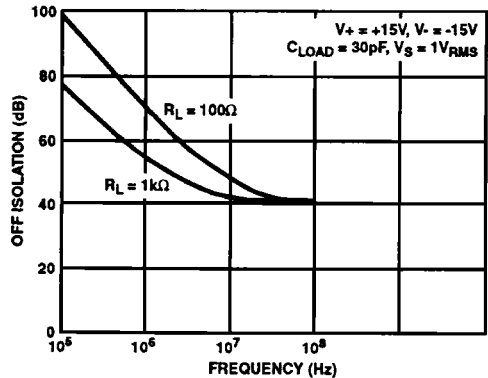

FIGURE 4. OFF ISOLATION vs FREQUENCY

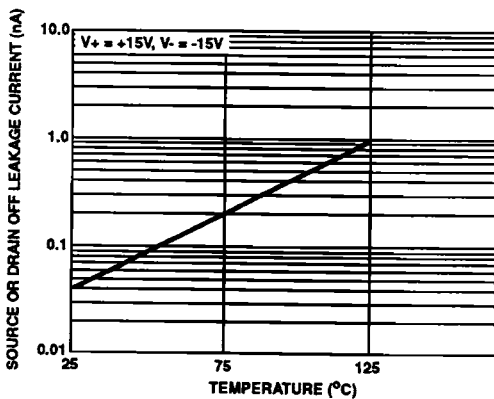

FIGURE 5. $I_{S(OFF)}$ OR $I_{D(OFF)}$ vs TEMPERATURE †

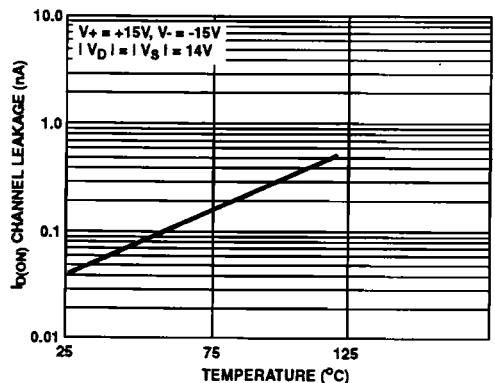
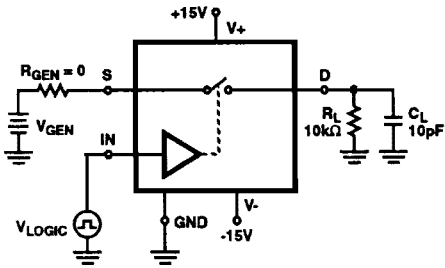

FIGURE 6. $I_{D(ON)}$ vs TEMPERATURE †

† The net leakage into the source or drain is the n-channel leakage minus the p-channel leakage. This difference can be positive, negative or zero depending on the analog voltage and temperature, and will vary greatly from unit to unit.

Typical Performance Curves (Continued)



7A. TEST CIRCUIT

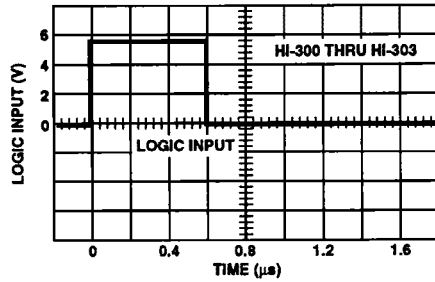

7B. $V_{IN(Logic)}$ vs TIME

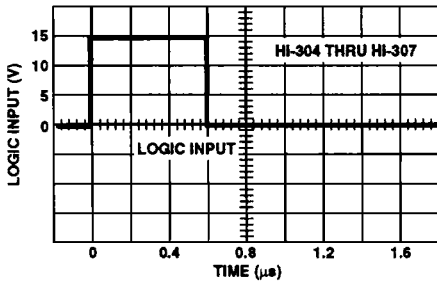

7C. $V_{IN(Logic)}$ vs TIME

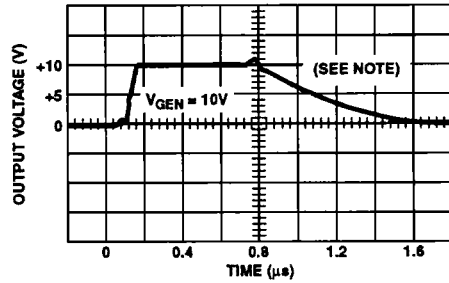

7D. V_{OUT} vs TIME

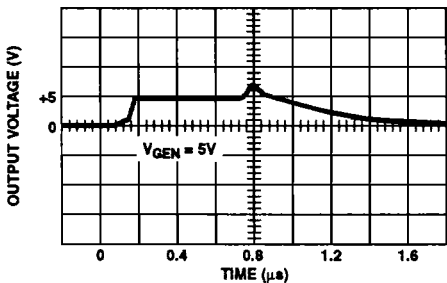

7E. V_{OUT} vs TIME

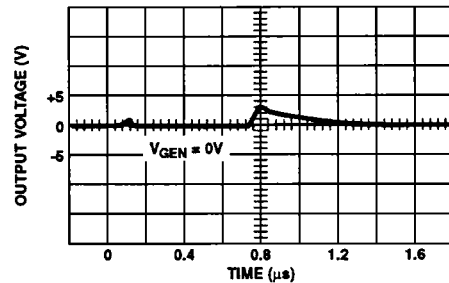

7F. V_{OUT} vs TIME

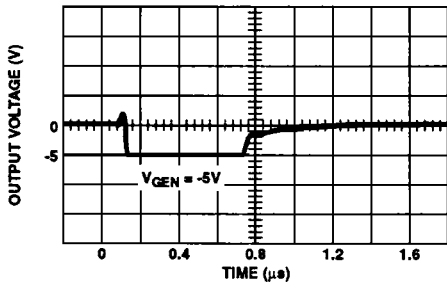

7G. V_{OUT} vs TIME

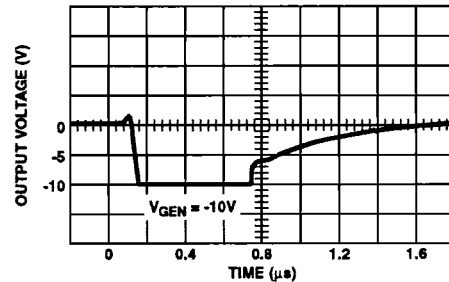

7H. V_{OUT} vs TIME

NOTE: If R_{GEN} , R_L or C_L is increased, there will be proportional increases in rise and/or fall RC times.

FIGURE 7. TYPICAL DELAY, RISE, FALL, SETTLING TIMES AND SWITCHING TRANSIENTS

Typical Performance Curves (Continued)

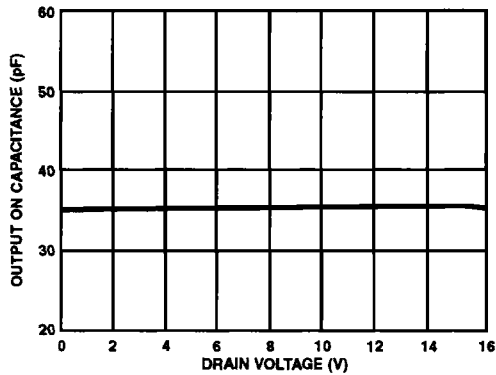

FIGURE 8. OUTPUT ON CAPACITANCE vs DRAIN VOLTAGE

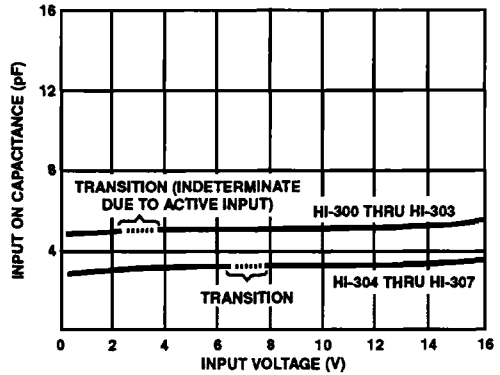

FIGURE 9. DIGITAL INPUT CAPACITANCE vs INPUT VOLTAGE

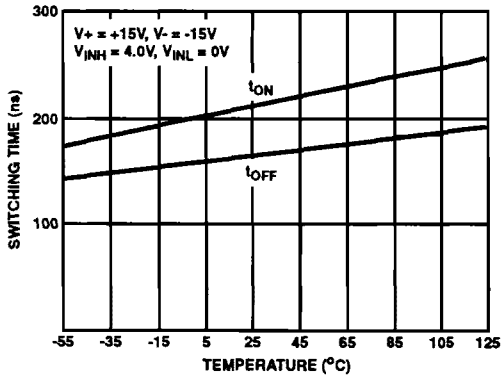

FIGURE 10. SWITCHING TIME vs TEMPERATURE, HI-300 THRU HI-303

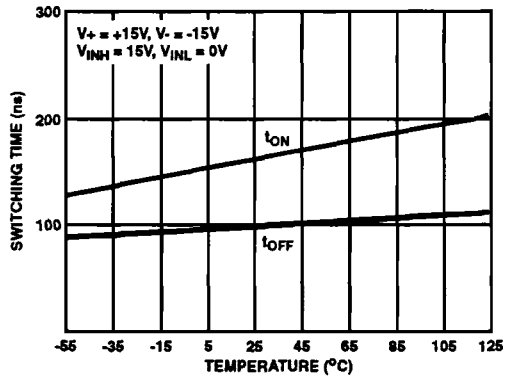

FIGURE 11. SWITCHING TIME vs TEMPERATURE, HI-304 THRU HI-307

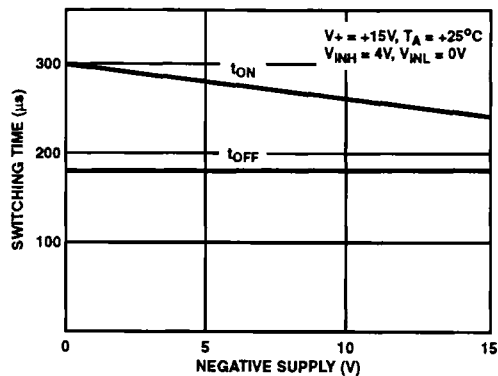

FIGURE 12. SWITCHING TIME vs NEGATIVE SUPPLY VOLTAGE, HI-300 THRU HI-303

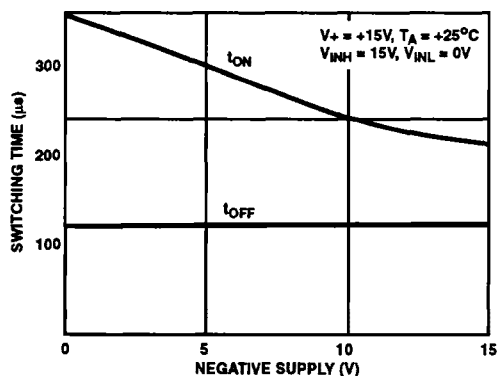

FIGURE 13. SWITCHING TIME vs NEGATIVE SUPPLY VOLTAGE, HI-304 THRU HI-307

Typical Performance Curves (Continued)

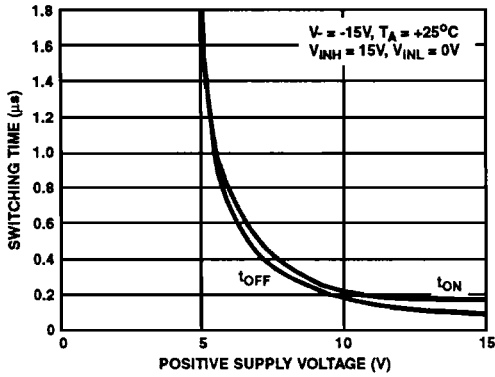

FIGURE 14. SWITCHING TIME vs POSITIVE SUPPLY VOLTAGE, HI-304 THRU HI-307

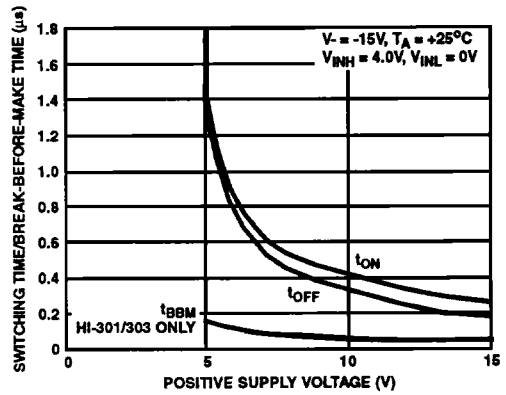

FIGURE 15. SWITCHING TIME AND BREAK-BEFORE-MAKE TIME vs POSITIVE SUPPLY VOLTAGE, HI-300 THRU HI-303

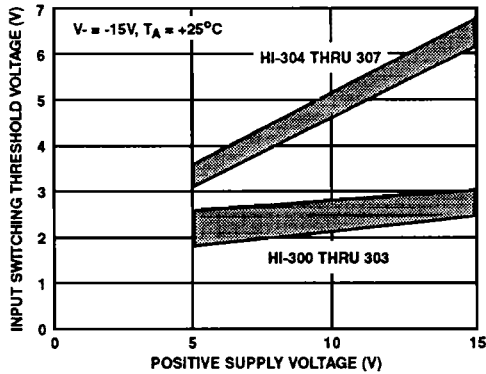

FIGURE 16. INPUT SWITCHING THRESHOLD vs POSITIVE SUPPLY VOLTAGE, HI-300 THRU HI-307

Test Circuits

SWITCH TYPE	V_{INH}
HI-300 thru HI-303	4V
HI-304 thru HI-307	15V

SWITCH TYPE	V_{INH}
HI-301, HI-303	5V
HI-305, HI-307	15V

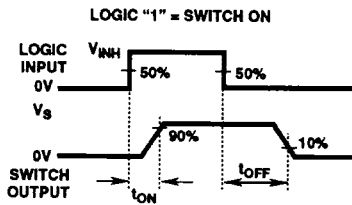
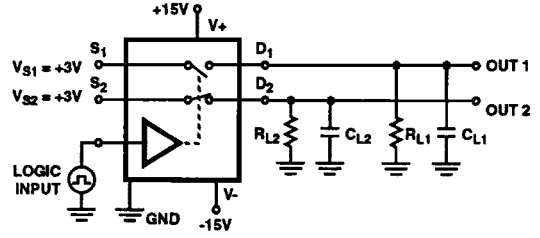
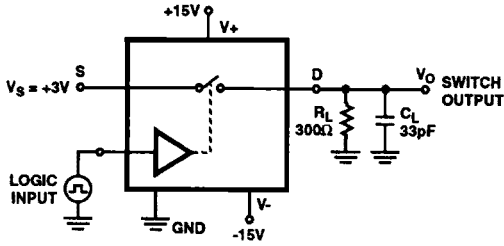

FIGURE 17. SWITCHING TEST CIRCUIT (t_{ON} , t_{OFF})

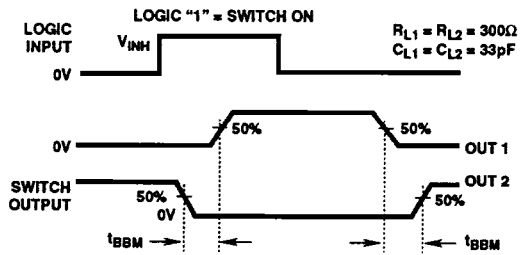

FIGURE 18. BREAK-BEFORE-MAKE TEST CIRCUIT (t_{BBM})