

DESCRIPTION

The MP28490 is a monolithic step-down switch mode converter with a built in internal power MOSFET. It achieves 5A continuous output current over a wide input supply range with excellent load and line regulation.

Current mode operation provides fast transient response and eases loop stabilization.

Fault condition protection includes cycle-by-cycle current limiting and thermal shutdown.

The MP28490 requires a minimum number of readily available standard external components and is available in an 8-pin SOIC package with exposed pad.

FEATURES

- Wide 4.5V to 30V Operating Input Range
- 5A Output Current
- 50mΩ Internal Power MOSFET Switch
- Power Good Indicator
- Fixed 420kHz Frequency
- Synchronizable up to 1.5MHz
- Cycle-by-Cycle Over Current Protection with hiccup
- Thermal Shutdown
- Output Adjustable from 0.8V to 15V
- Stable with Low ESR Output Ceramic Capacitors
- Available in a Thermally Enhanced 8-Pin SOIC Package

APPLICATIONS

- Digital Set Top Boxes
- Personal Video Recorders
- Broadband Communications
- Flat Panel Television and Monitors

"MPS" and "The Future of Analog IC Technology" are Registered Trademarks of Monolithic Power Systems, Inc.

TYPICAL APPLICATION

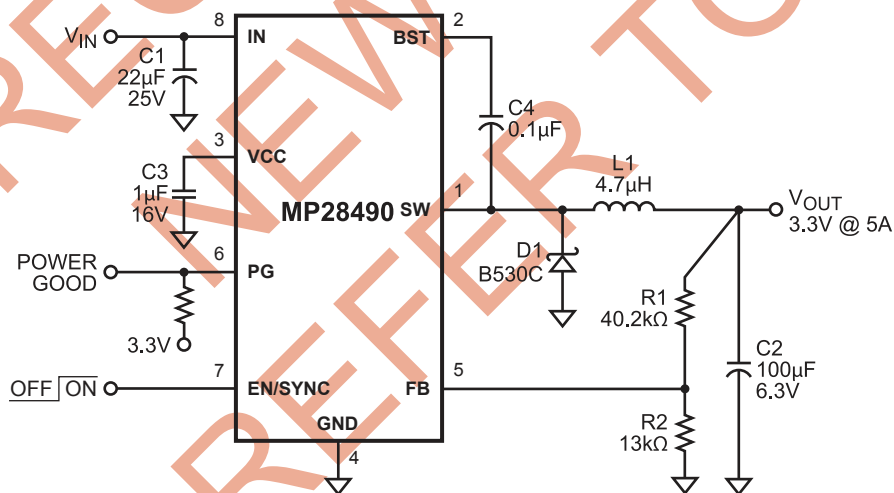

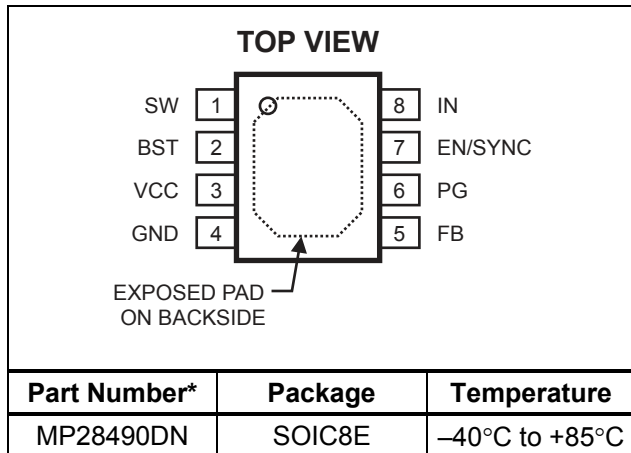
PACKAGE REFERENCE

* For Tape & Reel, add suffix -Z (eg. MP28490DN-Z)
 For RoHS Compliant Packaging, add suffix -LF
 (eg. MP28490DN-LF-Z)

ABSOLUTE MAXIMUM RATINGS ⁽¹⁾

Supply Voltage V_{IN} 32V
 V_{SW} -0.3V (-5V for < 10ns) to 33V
 V_{BS} $V_{SW} + 6V$
 All Other Pins..... -0.3V to +6V
 Junction Temperature..... 150°C
 Lead Temperature 260°C
 Storage Temperature -65°C to +150°C

Recommended Operating Conditions ⁽²⁾

Supply Voltage V_{IN} 4.5V to 30V
 Output Voltage V_{OUT} 0.8V to 15V
 Operating Temperature -40°C to +85°C

Thermal Resistance ⁽³⁾

	θ_{JA}	θ_{JC}
SOIC8E	50	10... °C/W

Notes:

- Exceeding these ratings may damage the device.
- The device is not guaranteed to function outside of its operating conditions.
- Measured on approximately 1" square of 1 oz copper.

ELECTRICAL CHARACTERISTICS

$V_{IN} = 12V$, $T_A = +25^\circ C$, unless otherwise noted.

Parameters	Symbol	Condition	Min	Typ	Max	Units
Feedback Voltage	V_{FB}	$4.5V \leq V_{IN} \leq 30V$	0.788	0.808	0.828	V
Feedback Current	I_{FB}	$V_{FB} = 0.8V$		10		nA
Switch On Resistance ⁽⁴⁾	$R_{DS(ON)}$			45		mΩ
Switch Leakage		$V_{EN} = 0V, V_{SW} = 0V$		0	10	μA
Current Limit ⁽⁴⁾				7.5	9	A
Oscillator Frequency	f_{SW}	$V_{FB} = 0.6V$	240	420	600	kHz
Fold-back Frequency		$V_{FB} = 0V$	25	115	205	kHz
Maximum Duty Cycle		$V_{FB} = 0.6V$	85	90		%
Minimum On Time	t_{ON}			100		ns
Under Voltage Lockout Threshold Rising			3.9	4.1	4.3	V
Under Voltage Lockout Threshold Hysteresis				880		mV
EN Input Low Voltage					0.4	V
EN Input High Voltage			1.2			V
EN Input Current		$V_{EN} = 2V$		2		μA
		$V_{EN} = 0V$		0		
Sync Frequency Range (Low)	F_{SYNCL}			300		kHz
Sync Frequency Range (High)	F_{SYNCH}			1.5		MHz
Enable Turnoff Delay	T_{OFF}			5.0		μs
Supply Current (Shutdown)		$V_{EN} = 0V$		0		μA
Supply Current (Quiescent)		$V_{EN} = 2V, V_{FB} = 1V$		0.9	1.1	mA
Thermal Shutdown				150		°C
Power Good Control						
Power Good Threshold Rising			0.69	0.74	0.79	V
Power Good Threshold Hysteresis				40		mV
PG Pin Level	V_{PG}	PG Sink 4mA			0.4	V

Note:

4) Guaranteed by design.

PIN FUNCTIONS

Pin #	Name	Description
1	SW	Switch Output.
2	BST	Bootstrap. This capacitor is needed to drive the power switch's gate above the supply voltage. It is connected between SW and BS pins to form a floating supply across the power switch driver.
3	VCC	Bias Supply. Decouple this pin with a 1 μ F ceramic capacitor.
4	GND	Ground. This pin is the voltage reference for the regulated output voltage. For this reason care must be taken in its layout. This node should be placed outside of the D1 to C1 ground path to prevent switching current spikes from inducing voltage noise into the part.
5	FB	Feedback. An external resistor divider from the output to GND, tapped to the FB pin sets the output voltage. To prevent current limit run away during a short circuit fault condition the frequency foldback comparator lowers the oscillator frequency when the FB voltage is below 250mV.
6	PG	Power Good Indicator. The output of this pin is LOW if the output voltage is 10% less than the nominal voltage; otherwise it is an open drain.
7	EN/SYNC	On/Off Control Input and Synchronization Pin.
8	IN	Supply Voltage. The MP28490 operates from a +4.5V to +30V unregulated input. C1 is needed to prevent large voltage spikes from appearing at the input.

TYPICAL PERFORMANCE CHARACTERISTICS

$V_{IN} = 12V$, $V_{OUT} = 3.3V$, $I_{OUT} = 5A$, $T_A = +25^{\circ}C$, unless otherwise noted.

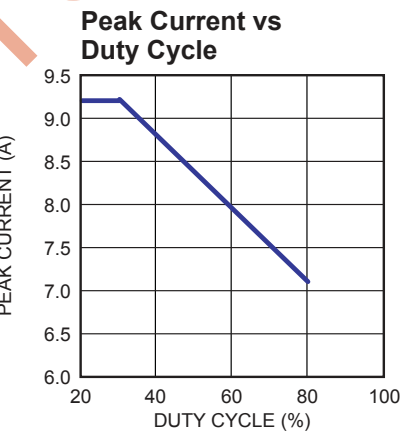
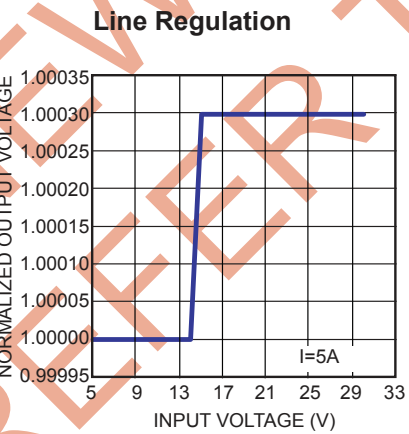
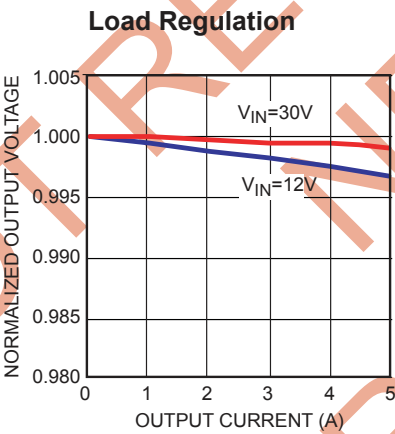
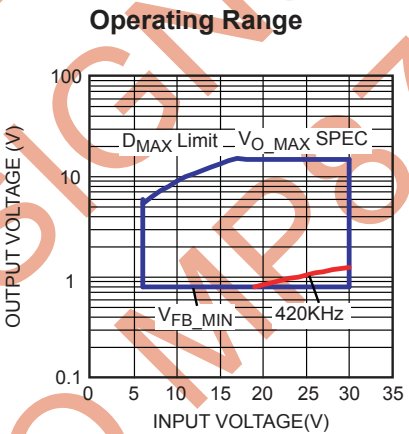
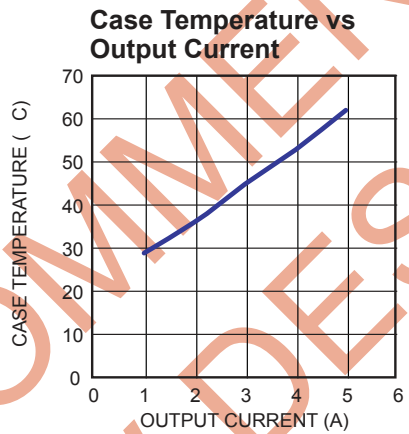
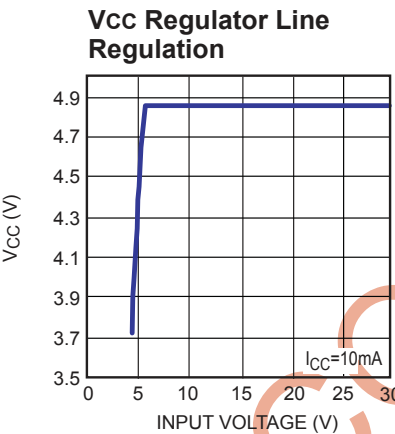
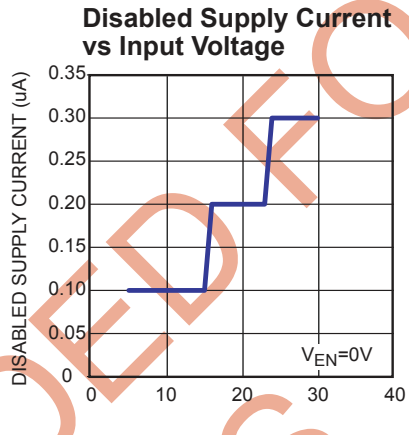
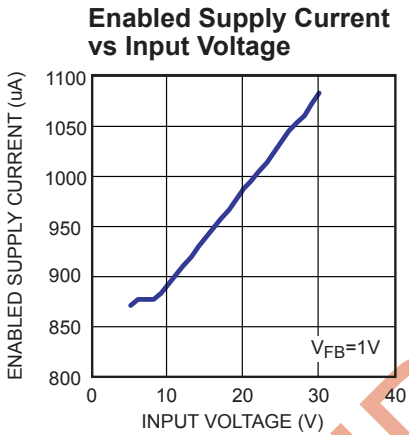
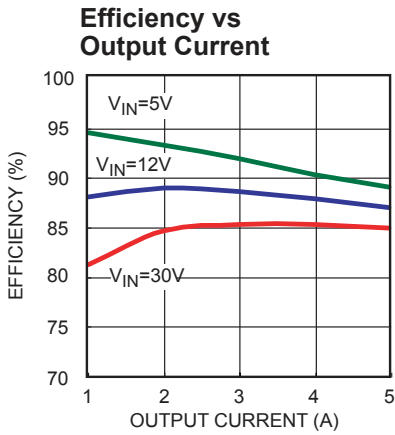

TYPICAL PERFORMANCE CHARACTERISTICS *(continued)*

$V_{IN} = 12V$, $V_{OUT} = 3.3V$, $I_{OUT} = 5A$, $T_A = +25^{\circ}C$, unless otherwise noted.

HICCUP Output Short

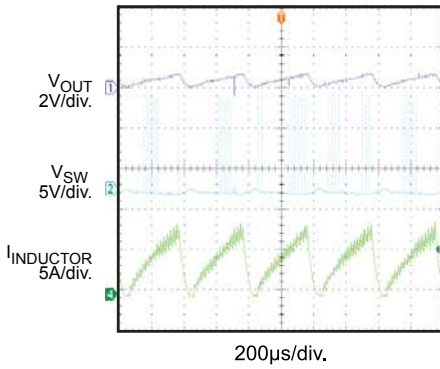

Power Up Without Load

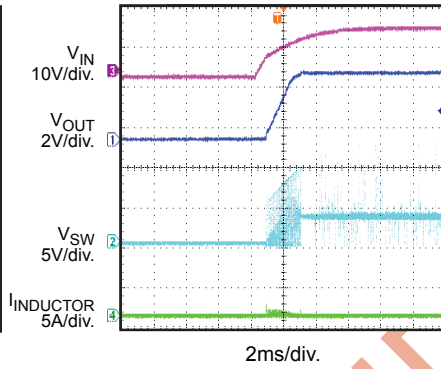

Power Up With 5A Load

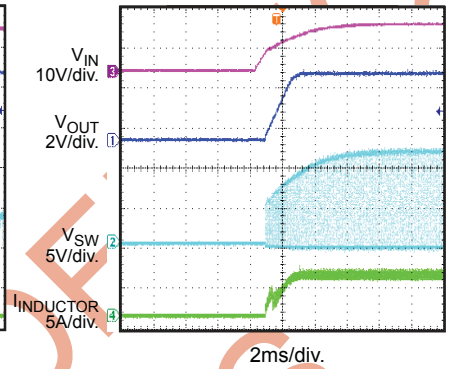

Enable Startup at Full Load

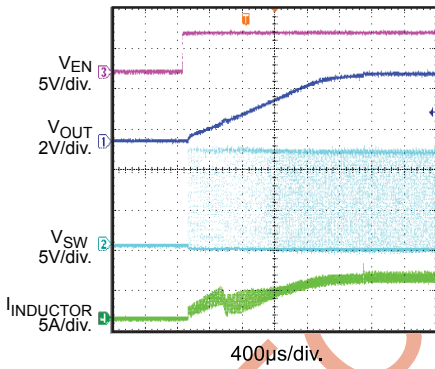

Enable Startup at No Load

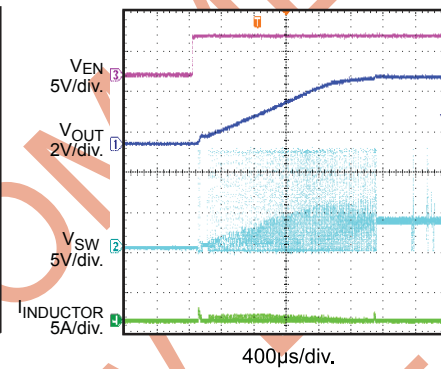

Input Ripple Voltage

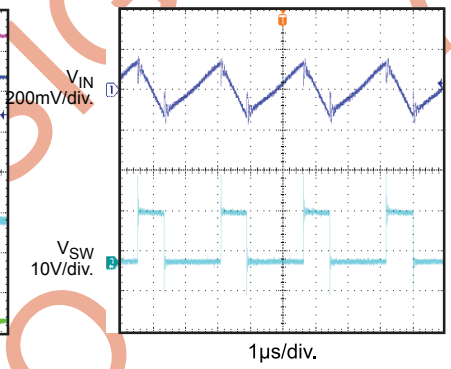

Output Ripple Voltage

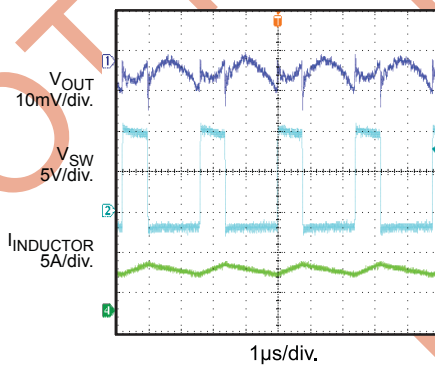

Load Transient Response

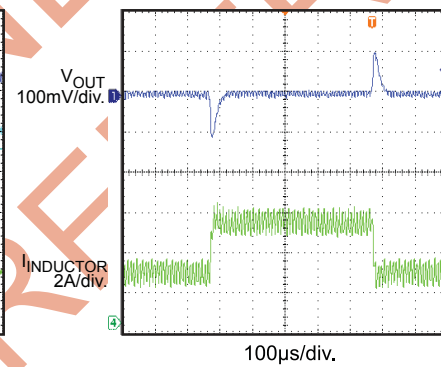

OPERATION

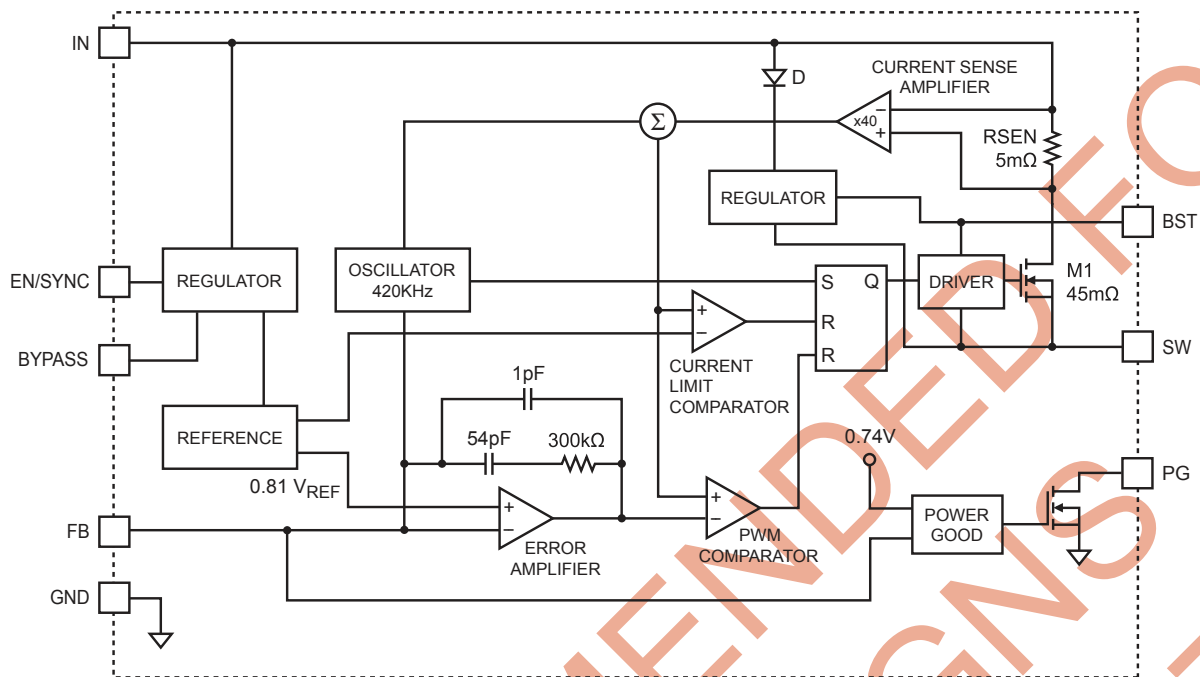

Figure 1—Functional Block Diagram

The MP28490 is a fixed frequency, synchronous, step-down switching regulator with an integrated high-side power MOSFET. It achieves 5A continuous output current over a wide input supply range with excellent load and line regulation. It provides a single highly efficient solution with current mode control for fast loop response and easy compensation.

The MP28490 operates in a fixed frequency, peak current control mode to regulate the output voltage. A PWM cycle is initiated by the internal clock. The integrated high-side power MOSFET is turned on and remains on until its current reaches the value set by the COMP voltage. When the power switch is off, it remains off until the next clock cycle starts. If, in 90% of one PWM period, the current in the power MOSFET does not reach the COMP set current value, the power MOSFET will be forced to turn off.

Power Good Indicator

When the FB is below 0.74V, the PG pin will be internally pulled low. When the FB is above 0.74V, the PG becomes an open-drain output.

Error Amplifier

The error amplifier compares the FB pin voltage with the internal 0.81V reference (REF) and outputs a current proportional to the difference between the two. This output current is then used to charge or discharge the internal compensation network to form the COMP voltage, which is used to control the power MOSFET current. The optimized internal compensation network minimizes the external component counts and simplifies the control loop design.

Internal Regulator

Most of the internal circuitries are powered from the 5V internal regulator. This regulator takes the VIN input and operates in the full VIN range. When VIN is greater than 5.0V, the output of the regulator is in full regulation. When VIN is lower than 5.0V, the output decreases. Since this internal regulator provides the bias current for the bottom gate driver that requires significant amount of current depending upon the external MOSFET selection, a 1uF ceramic capacitor for decoupling purpose is required.

Enable/Synch Control

The MP28490 has a dedicated Enable/Synch control pin (EN/SYNC). By pulling it high or low, the IC can be enabled and disabled by EN. Tie EN to VIN for automatic start up. To disable the part, EN must be pulled low for at least 5 μ s.

The MP28490 can be synchronized to external clock range from 300KHz up to 1.5MHz through the EN/SYNC pin. The internal clock rising edge is synchronized to the external clock rising edge.

Under-Voltage Lockout (UVLO)

Under-voltage lockout (UVLO) is implemented to protect the chip from operating at insufficient supply voltage. The MP28490 UVLO comparator monitors the output voltage of the internal regulator, BYPASS. The UVLO rising threshold is about 4.0V while its falling threshold is about 3.6V.

Internal Soft-Start

The soft-start is implemented to prevent the converter output voltage from overshooting during startup. When the chip starts, the internal circuitry generates a soft-start voltage (SS) ramping up from 0V to 1.2V. When it is lower than the internal reference (REF), SS overrides REF so the error amplifier uses SS as the reference. When SS is higher than REF, REF regains control.

Over-Current-Protection and Hiccup

The MP28490 has cycle-by-cycle over current limit when the inductor current peak value exceeds the set current limit threshold. Meanwhile, output voltage starts to drop until FB is below the Under-Voltage(UV) threshold, typically 30% below the reference. Once a UV is triggered, the MP28490 enters hiccup mode to periodically restart the part. This protection mode is especially useful when the output is dead-short to ground. The average short circuit current is greatly reduced to alleviate the thermal issue and to protect the regulator. The MP28490 exits the hiccup mode once the over current condition is removed.

Thermal Shutdown

Thermal shutdown is implemented to prevent the chip from operating at exceedingly high temperatures. When the silicon die temperature is higher than 150°C, it shuts down the whole chip. When the temperature is lower than its lower threshold, typically 140°C, the chip is enabled again.

Floating Driver and Bootstrap Charging

The floating power MOSFET driver is powered by an external bootstrap capacitor. This floating driver has its own UVLO protection. This UVLO's rising threshold is 2.2V with a hysteresis of 150mV. The bootstrap capacitor voltage is regulated internally (Figure 2). Even at no load condition, as long as V_{IN} is 3V higher than V_{OUT} , C4 will have enough voltage provided by V_{IN} through D1, M1, C4, L1 and C2. If $(V_{IN}-V_{SW})$ is more than 5V, U2 will regulate M1 to maintain a 5V BST voltage across C4.

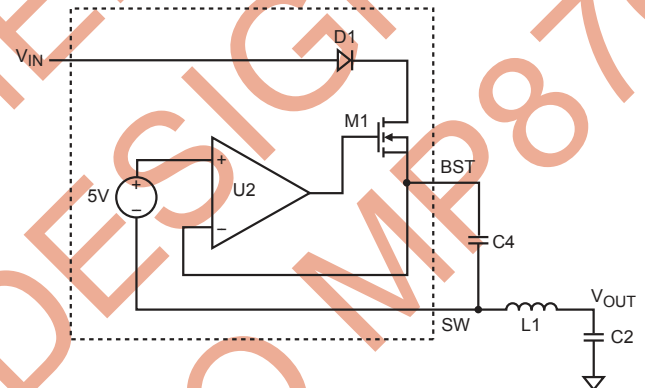

Figure 2—Internal Bootstrap Charging Circuit

Startup and Shutdown

If both V_{IN} and EN are higher than their appropriate thresholds, the chip starts. The reference block starts first, generating stable reference voltage and currents, and then the internal regulator is enabled. The regulator provides stable supply for the remaining circuitries.

Three events can shut down the chip: EN low, V_{IN} low and thermal shutdown. In the shutdown procedure, the signaling path is first blocked to avoid any fault triggering. The COMP voltage and the internal supply rail are then pulled down. The floating driver is not subject to this shutdown command.

APPLICATION INFORMATION

The schematic on the front page shows a typical MP28490 application. The IC can provide up to 5A output current at a nominal output voltage of 3.3V. For proper thermal performance, the exposed pad of the device must be soldered down to the printed circuit board.

Setting the Output Voltage

The external resistor divider is used to set the output voltage (see the schematic on front page). The feedback resistor R1 also sets the feedback loop bandwidth with the internal compensation capacitor (see Figure 1). Choose R1 to be around 40.2kΩ for optimal transient response. R2 is then given by:

$$R2 = \frac{R1}{\frac{V_{OUT}}{0.8V} - 1}$$

Table 1—Resistor Selection for Common Output Voltages

V _{OUT} (V)	R1 (kΩ)	R2 (kΩ)
1.8	40.2 (1%)	32.4 (1%)
2.5	40.2 (1%)	19.1 (1%)
3.3	40.2 (1%)	13 (1%)
5	40.2 (1%)	7.68 (1%)

Selecting the Inductor

A 1μH to 10μH inductor with a DC current rating of at least 25% percent higher than the maximum load current is recommended for most applications. For highest efficiency, the inductor DC resistance should be less than 15mΩ. For most designs, the inductance value can be derived from the following equation.

$$L = \frac{V_{OUT} \times (V_{IN} - V_{OUT})}{V_{IN} \times \Delta I_L \times f_{OSC}}$$

Where ΔI_L is the inductor ripple current.

Choose inductor current to be approximately 30% of the maximum load current, 5A. The maximum inductor peak current is:

$$I_{L(MAX)} = I_{LOAD} + \frac{\Delta I_L}{2}$$

Under light load conditions below 100mA, larger inductance is recommended for improved efficiency.

Output Rectifier Diode

The output rectifier diode supplies the current to the inductor when the high-side switch is off. To reduce losses due to the diode forward voltage and recovery times, use a Schottky diode.

Choose a diode whose maximum reverse voltage rating is greater than the maximum input voltage, and whose current rating is greater than the maximum load current. Table 2 lists example Schottky diodes and manufacturers.

Table 2—Diode Selection Guide

Diode	Voltage/Current Rating	Manufacture
B530C	30V, 5A	Diodes Inc.
MBRD630CT	30V, 6A	On Semi

Selecting the Input Capacitor

The input capacitor (C1) reduces the surge current drawn from the input and the switching noise from the device. The input capacitor impedance at the switching frequency should be less than the input source impedance to prevent high frequency switching current from passing to the input. Ceramic capacitors with X5R or X7R dielectrics are highly recommended because of their low ESR and small temperature coefficients. For 6A output applications, a 22μF capacitor is sufficient.

Selecting the Output Capacitor

The output capacitor (C2) keeps output voltage small and ensures regulation loop stability. The output capacitor impedance should be low at the switching frequency. Ceramic capacitors with X5R or X7R dielectrics are recommended.

PC Board Layout

The high current paths (GND, IN and SW) should be placed very close to the device with short, direct and wide traces. The input capacitor needs to be as close as possible to the IN and GND pins. The external feedback resistors should be placed next to the FB pin. Keep the switching node SW short and away from the feedback network. Keep the EN trace away from the feedback network, and also an isolation with ground trace between the EN and FB pins (highly recommended).

External Bootstrap Diode

An external bootstrap diode may enhance the efficiency of the regulator, the applicable conditions of external BST diode are:

- $V_{OUT}=5V$ or $3.3V$; and
- Duty cycle is high: $D = \frac{V_{OUT}}{V_{IN}} > 65\%$

In these cases, an external BST diode is recommended from the output of the voltage regulator to BST pin, as shown in Fig.3

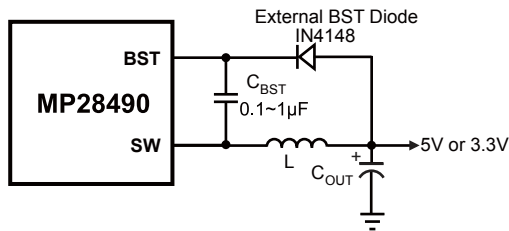
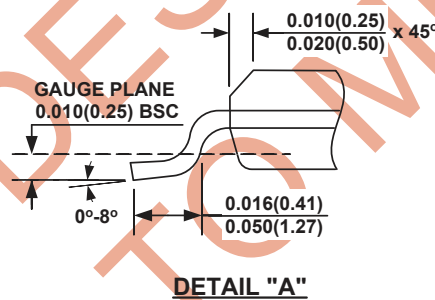
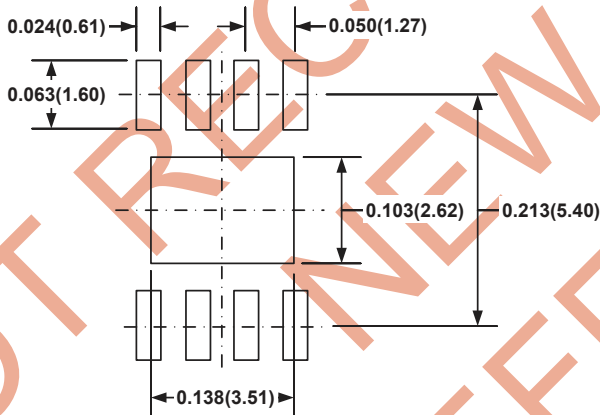
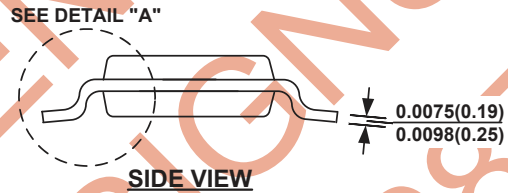
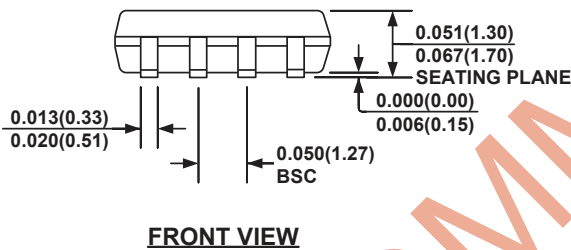
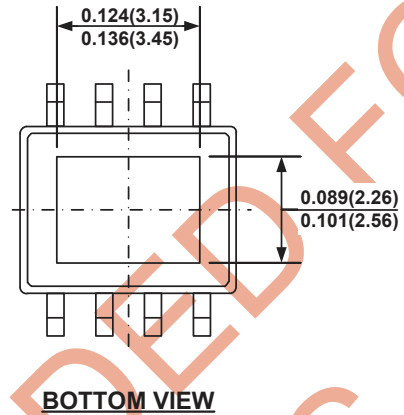
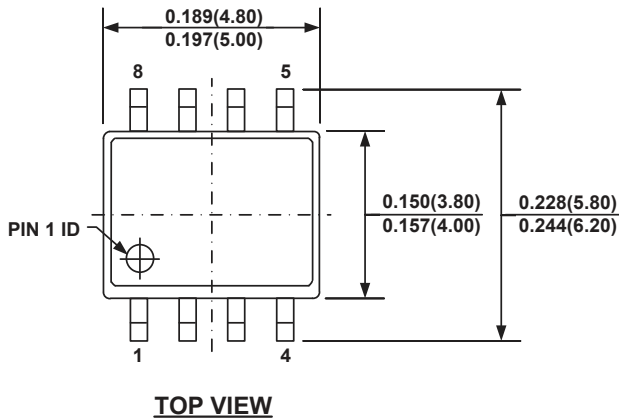

Figure 3—Add Optional External Bootstrap Diode to Enhance Efficiency

The recommended external BST diode is IN4148, and the BST cap is 0.1~1µF.

PACKAGE INFORMATION

SOIC8E (EXPOSED PAD)



NOTE:

- 1) CONTROL DIMENSION IS IN INCHES. DIMENSION IN BRACKET IS IN MILLIMETERS.
- 2) PACKAGE LENGTH DOES NOT INCLUDE MOLD FLASH, PROTRUSIONS OR GATE BURRS.
- 3) PACKAGE WIDTH DOES NOT INCLUDE INTERLEAD FLASH OR PROTRUSIONS.
- 4) LEAD COPLANARITY (BOTTOM OF LEADS AFTER FORMING) SHALL BE 0.004" INCHES MAX.
- 5) DRAWING CONFORMS TO JEDEC MS-012, VARIATION BA.
- 6) DRAWING IS NOT TO SCALE.

NOTICE: The information in this document is subject to change without notice. Users should warrant and guarantee that third party Intellectual Property rights are not infringed upon when integrating MPS products into any application. MPS will not assume any legal responsibility for any said applications.