

Features

- Long life and robust package
- Standard Package: 2,000pcs/ Reel
- MSL (Moisture Sensitivity Level): 3
- Halogen-free
- RoHS compliant

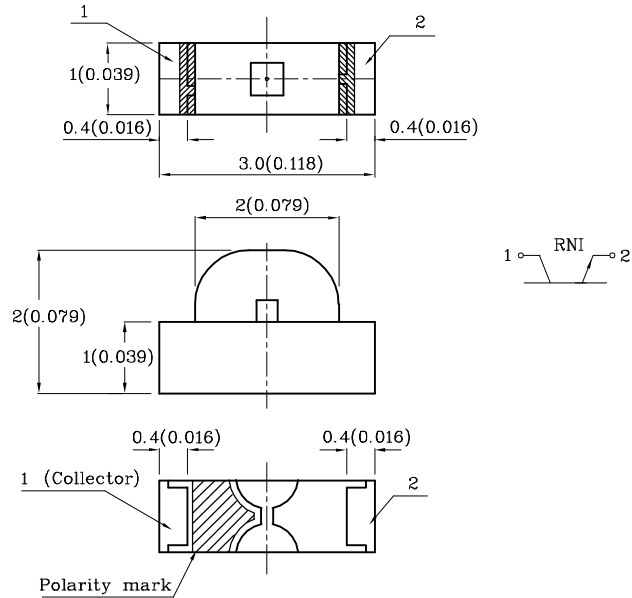

Package Schematics



Notes:

1. All dimensions are in millimeters (inches).
2. Tolerance is $\pm 0.15(0.006)$ unless otherwise noted.
3. Specifications are subject to change without notice.

Electrical / Optical Characteristics at TA=25°C

Symbol	Parameter	Min.	Typ.	Max.	Unit	Test Condition
V _{BR CEO}	Collector-to-Emitter Breakdown Voltage	30	-	-	V	I _C = 100μA E _e = 0mW/cm ²
V _{BR ECO}	Emitter-to-Collector Breakdown Voltage	5	-	-	V	I _E = 100μA E _e = 0mW/cm ²
V _{CE(SAT)}	Collector-to-Emitter Saturation Voltage	-	-	0.8	V	I _C = 2mA E _e = 20mW/cm ²
I _{CEO}	Collector Dark Current	-	-	100	nA	V _{CE} = 10V E _e = 0mW/cm ²
T _R	Rise Time (10% to 90%)	-	15	-	μs	V _{CE} = 5V I _C = 1mA R _i = 1KΩ
T _F	Fall Time (90% to 10%)	-	15	-	μs	
I _(ON)	On State Collector Current	0.2	0.4	-	mA	V _{CE} = 5V E _e = 1mW/cm ² λ = 940nm
λ _{0.1}	Range of spectral bandwidth	420	-	1120	nm	-
λ _p	Wavelength of peak Sensitivity	-	940	-	nm	-
2θ _{1/2}	Angle of half sensitivity	-	160	-	deg	-

Absolute Maximum Ratings at TA=25°C

Parameter	Maximum Ratings
Collector-to-Emitter Voltage	30V
Emitter-to-Collector Voltage	5V
Power Dissipation at (or below) 25°C Free Air Temperature	100mW
Operating / Storage Temperature Range	-40 ~ +85°C

A Relative Humidity between 40% and 60% is recommended in ESD-protected work areas to reduce static build up during assembly process (Reference JEDEC/JESD625-A and JEDEC/J-STD-033)

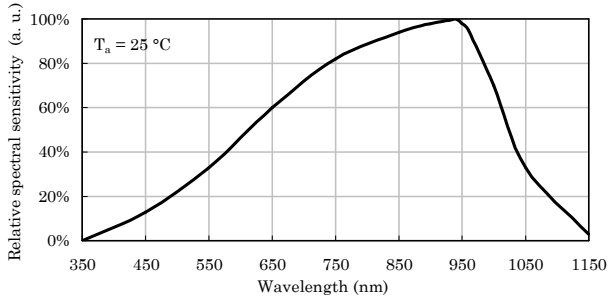

Relative Intensity Vs. CIE Wavelength

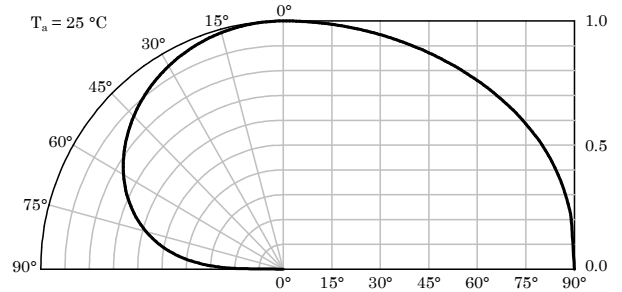

Spatial Distribution

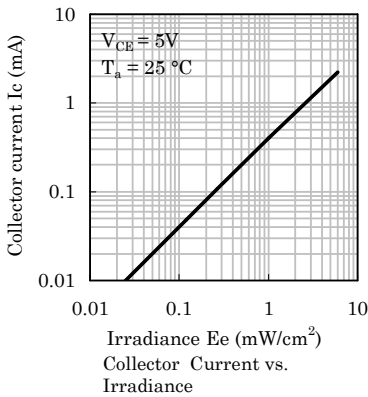

Collector Current vs. Irradiance

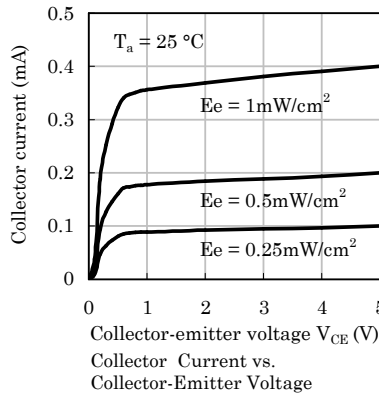

Collector Current vs. Collector-Emitter Voltage

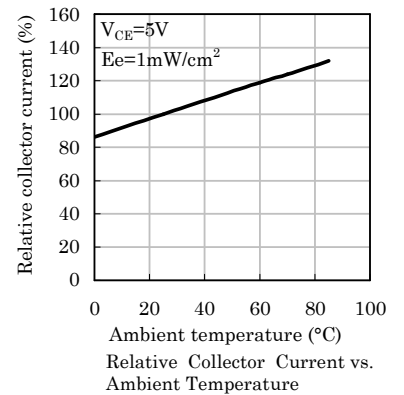

Relative Collector Current vs. Ambient Temperature

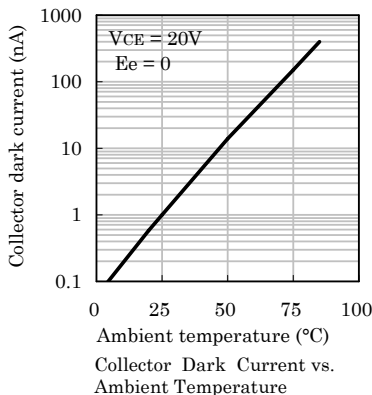

Collector Dark Current vs. Ambient Temperature

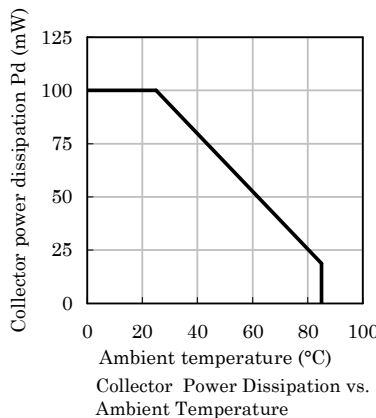

Collector Power Dissipation vs. Ambient Temperature

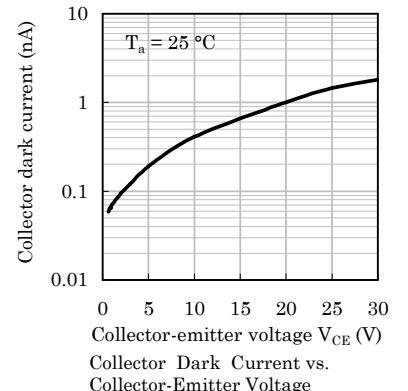

Collector Dark Current vs. Collector-Emitter Voltage

❖ LED is recommended for reflow soldering and soldering profile is shown below.

❖ The device has a single mounting surface. The device must be mounted according to the specifications.

Reflow Soldering Profile for SMD Products (Pb-Free Components)

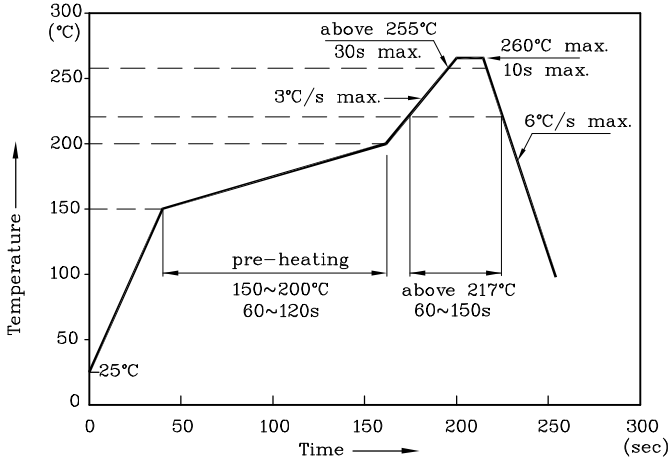

Notes:

1. All temperatures refer to the center of the package, measured on the package body surface facing up during reflow.
2. Do not apply any stress to the LED during high temperature conditions.
3. Maximum number of soldering passes: 2

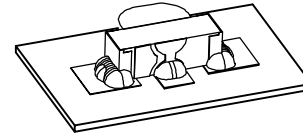

❖ Recommended Soldering Pattern (Units : mm; Tolerance: ± 0.1)

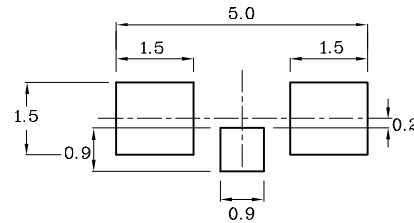

❖ Reel Dimension (Units : mm)

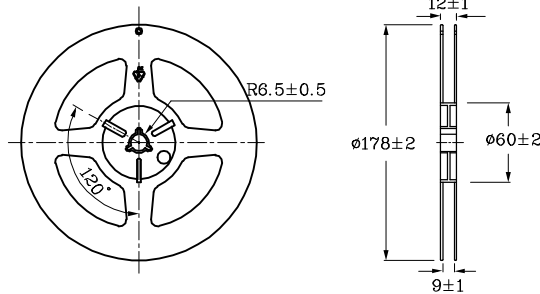

❖ Tape Specification (Units : mm)

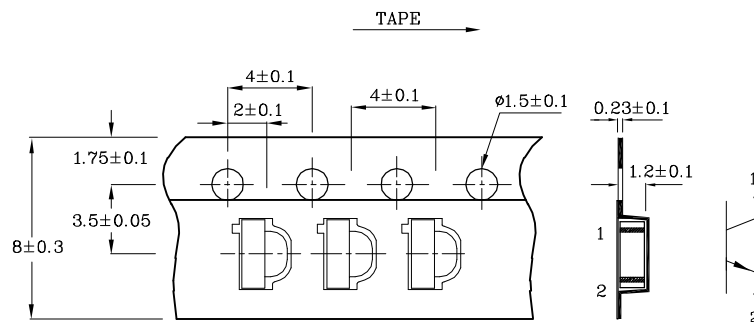

PACKING & LABEL SPECIFICATIONS

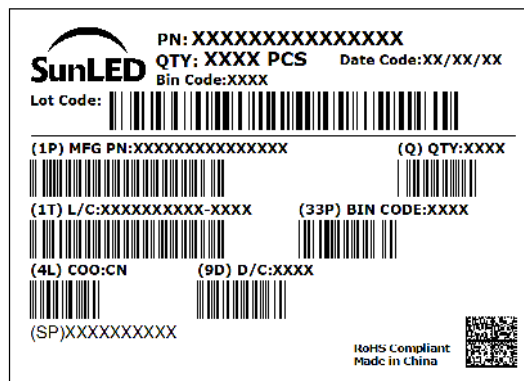
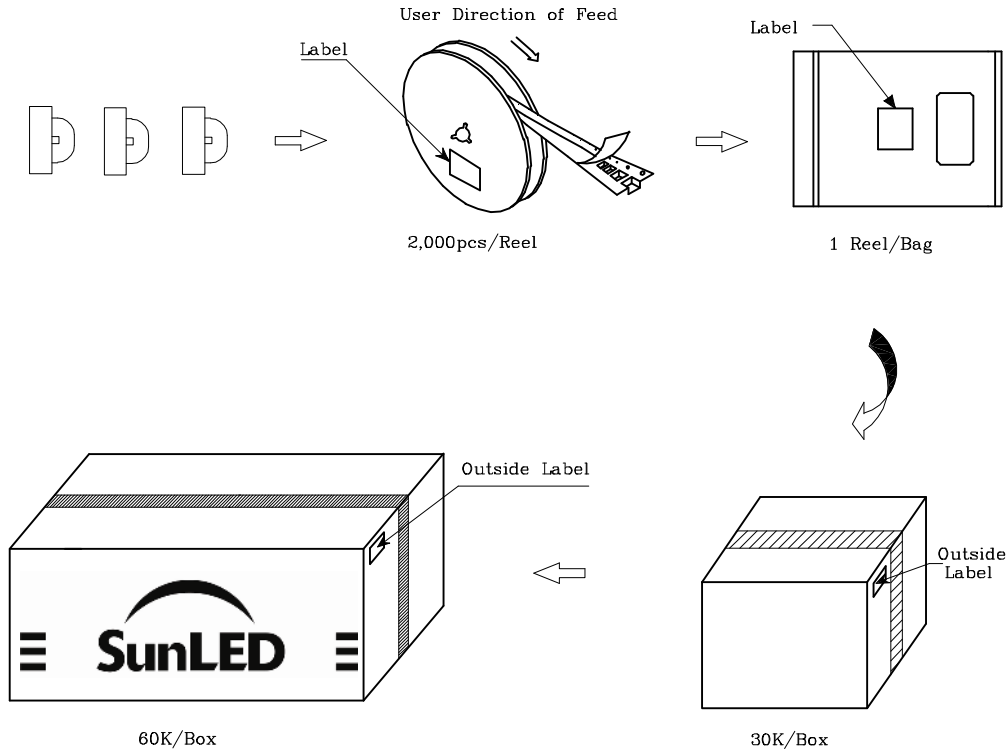

TERMS OF USE

1. Data presented in this document reflect statistical figures and should be treated as technical reference only.
2. Contents within this document are subject to improvement and enhancement changes without notice.
3. The product(s) in this document are designed to be operated within the electrical and environmental specifications indicated on the datasheet. User accepts full risk and responsibility when operating the product(s) beyond their intended specifications.
4. The product(s) described in this document are intended for electronic applications in which a person's life is not reliant upon the LED. Please consult with a SunLED representative for special applications where the LED may have a direct impact on a person's life.
5. The contents within this document may not be altered without prior consent by SunLED.
6. Additional technical notes are available at <https://www.SunLEDusa.com/TechnicalNotes.asp>