

## 2A, Low Input Voltage, Ultra-Low Dropout LDO Regulator with Enable

### General Description

The RTQ2516 is a high performance positive voltage regulator designed for use in applications requiring ultra-low input voltage and ultra-low dropout voltage at up to 2 amperes. It operates with an input voltage as low as 1.4V, with output voltage programmable as low as 0.5V. The RTQ2516 features ultra low dropout, ideal for applications where output voltage is very close to input voltage. Additionally, the RTQ2516 has an enable pin to further reduce power dissipation while shutdown. The RTQ2516 provides excellent regulation over variations in line, load and temperature. The RTQ2516 is available in the SOP-8 (Exposed Pad) package. The output voltage can be set by an external divider depending on how the FB pin is configured.

### Ordering Information

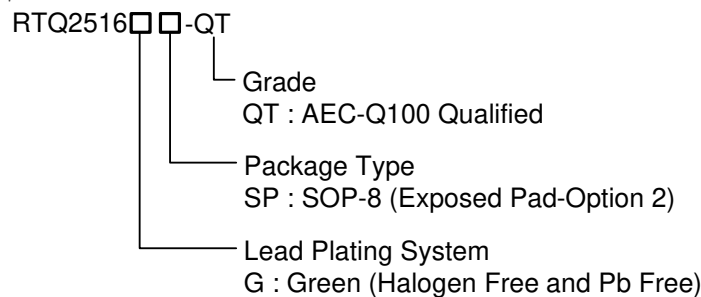

Note :

Richtek products are :

- ▶ RoHS compliant and compatible with the current requirements of IPC/JEDEC J-STD-020.
- ▶ Suitable for use in SnPb or Pb-free soldering processes.

### Features

- AEC-Q100 Grade 2 Qualified
- Input Voltage as Low as 1.4V
- Ultra-Low Dropout Voltage 400mV at 2A
- Over-Current Protection
- Over-Temperature Protection
- 1µA Input Current in Shutdown Mode
- Enable Control
- RoHS Compliant and Halogen Free

### Applications

- Telecom/Networking Cards
- Motherboards/Peripheral Cards
- Industrial Applications
- Wireless Infrastructure
- Set Top Box
- Medical Equipment
- Notebook Computers
- Battery Powered Systems

### Pin Configuration

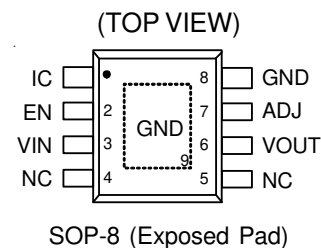

### Simplified Application Circuit

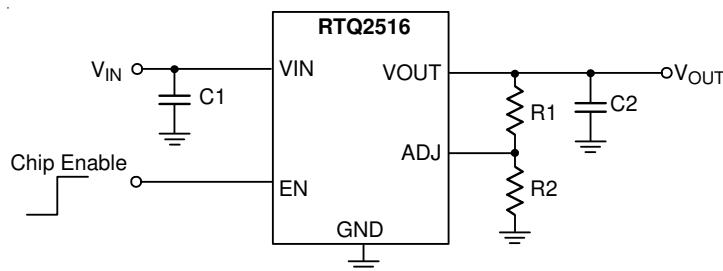

## Marking Information

|                            |
|----------------------------|
| RTQ2516<br>GSPQTYMDNN<br>• |
|----------------------------|

RTQ2516GSPQT : Product Number  
YMDNN : Date Code

## Functional Pin Description

| Pin No.               | Pin Name | Pin Function   |
|-----------------------|----------|--|
| 1                     | IC       | Internal connection. Keep this pin floating for normal operation.  |
| 4, 5                  | NC       | No internal connection.  |
| 2                     | EN       | Chip enable (Active-High). Pulling this pin below 0.4V to turn the regulator off. The device will be enabled if this pin is left open. Connect to VIN for controlling by VIN.  |
| 3                     | VIN      | Power input. For regulation at full load, the input to this pin must be between (V <sub>OUT</sub> + 0.5V) and 6V. Minimum input voltage is 1.4V. A large bulk capacitance should be placed closely to this pin to ensure that the input supply does not sag below 1.4V. A minimum of 10 $\mu$ F ceramic capacitor should be placed directly at this pin. |
| 6                     | VOUT     | Output of the regulator. A minimum of 10 $\mu$ F capacitor should be placed directly at this pin.  |
| 7                     | ADJ      | Feedback voltage input. If connected to the VOUT pin, the output voltage will be set at 0.5V. If external feedback resistors are used, the output voltage will be determined by the resistor ratio.  |
| 8,<br>9 (Exposed pad) | GND      | Ground. The exposed pad must be soldered to a large PCB and connected to GND for maximum power dissipation.  |

**Functional Block Diagram**

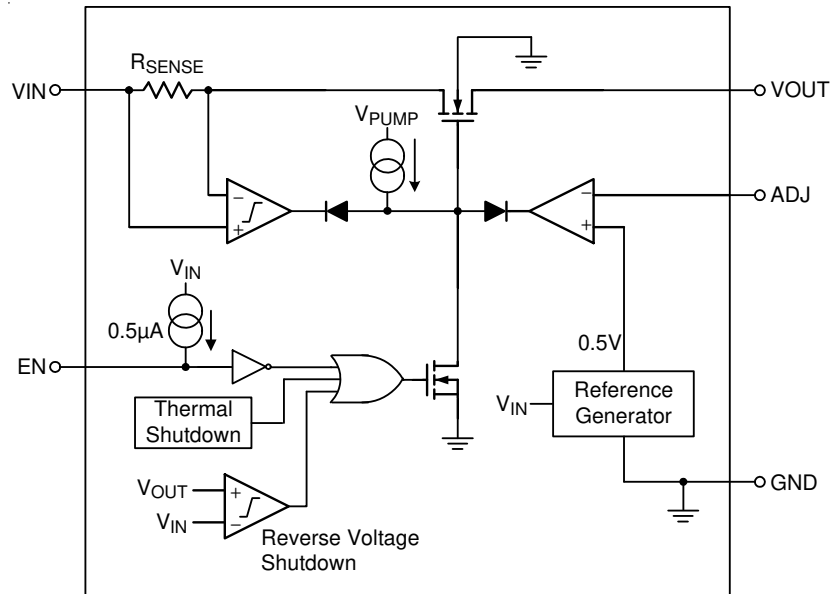

**Operation**

The RTQ2516 is a low input voltage low dropout LDO that can support the input voltage range from 1.4V to 6V and the output current can be up to 2A. The RTQ2516 uses internal charge pump to achieve low input voltage operation and the internal compensation network is well designed to achieve fast transient response with good stability. In steady-state operation, the feedback voltage is regulated to the reference voltage by the internal regulator. When the feedback voltage signal is less than the reference, the on resistance of the power MOSFET is decreased to increase the output current through the power MOSFET, and the feedback voltage will be charge back to reference. If the feedback voltage is less than the reference, the power MOSFET current is decreased to make the output voltage discharge back to reference by the loading current.

**Reverse Current Protection**

The reverse current protection is guarantee by the N-MOSFET with bulk capacitors connected to GND and the internal circuit. The reverse voltage detection circuit shuts the total loop down if the output voltage is higher than input voltage.

**Output Under-Voltage Protection (UVP) and Over-Current Fold-Back**

When the feedback voltage is lower than 0.15V after internal soft-start end, the UVP is triggered. If the over current condition is trigged during UVP state, the OC limit current will be decreased to limit the output power and change into re-soft-start state at the same time.

**Soft-Start**

An internal current source charges an internal capacitor to build the soft-start ramp voltage. During the soft-start state, the output current will be limited to prevent the inrush current.

**Over-Temperature Protection (OTP)**

When the device triggers the OTP, the device shuts down until the temperature back to normal and move to re-soft-start state.

## Absolute Maximum Ratings (Note 1)

- Supply Voltage,  $V_{IN}$  ----- 0.3V to 7V
- Other Pins ----- 0.3V to 7V
- Power Dissipation,  $P_D @ T_A = 25^\circ\text{C}$   
 SOP-8 (Exposed Pad) ----- 2.500W
- Package Thermal Resistance (Note 2)  
 SOP-8 (Exposed Pad),  $\theta_{JA}$  ----- 40°C/W  
 SOP-8 (Exposed Pad),  $\theta_{JC}$  ----- 8°C/W
- Lead Temperature (Soldering, 10 sec.) ----- 260°C
- Junction Temperature ----- 150°C
- Storage Temperature Range ----- -65°C to 150°C
- ESD Susceptibility (Note 3)  
 HBM (Human Body Model) ----- 2kV

## Recommended Operating Conditions (Note 4)

- Supply Voltage,  $V_{IN}$  ----- 1.4V to 6V
- Junction Temperature Range ----- -40°C to 125°C

## Electrical Characteristics

( $V_{IN} = 1.4\text{V to }6\text{V}$ ,  $I_{OUT} = 10\mu\text{A to }2\text{A}$ ,  $V_{ADJ} = V_{OUT}$ ,  $-40^\circ\text{C} \leq T_A \leq 105^\circ\text{C}$ , unless otherwise specified)

| Parameter             | Symbol            | Test Conditions  | Min    | Typ | Max    | Unit          |
|-----------------------|-------------------|--|--------|-----|--------|---------------|
| Quiescent Current     | $I_Q$             | $V_{IN} = 3.3\text{V}$ , $I_{OUT} = 0\text{A}$   | --     | 0.7 | 1.5    | mA            |
| Shutdown Current      | $I_{SHDN}$        | $V_{IN} = 6\text{V}$ , $V_{EN} = 0\text{V}$  | --     | 1.5 | 10     | $\mu\text{A}$ |
| Line Regulation       | $\Delta V_{LINE}$ | $I_{OUT} = 10\text{mA}$  | --     | 0.2 | 0.4    | %/V           |
| Load Regulation       | $\Delta V_{LOAD}$ | $I_{OUT} = 10\text{mA to }2\text{A}$   | --     | 0.5 | 1.5    | %             |
| Dropout Voltage       | $V_{DROP}$        | $I_{OUT} = 1\text{A}$ , $V_{IN} \geq 1.6\text{V}$  | --     | 120 | 200    | mV            |
|                       |                   | $I_{OUT} = 1\text{A}$ , $1.4\text{V} < V_{IN} < 1.6\text{V}$   | --     | --  | 400    |               |
|                       |                   | $I_{OUT} = 1.5\text{A}$ , $V_{IN} \geq 1.6\text{V}$  | --     | 180 | 300    |               |
|                       |                   | $I_{OUT} = 1.5\text{A}$ , $1.4\text{V} < V_{IN} < 1.6\text{V}$                                       | --     | --  | 500    |               |
|                       |                   | $I_{OUT} = 2\text{A}$ , $V_{IN} \geq 1.6\text{V}$  | --     | 240 | 400    |               |
|                       |                   | $I_{OUT} = 2\text{A}$ , $1.4\text{V} < V_{IN} < 1.6\text{V}$   | --     | --  | 600    |               |
| Current Limit         | $I_{LIM}$         | $V_{IN} = 3.3\text{V}$   | 2.3    | 3   | 4.4    | A             |
| <b>Feedback</b>       |                   |  |        |     |        |               |
| ADJ Reference Voltage | $V_{REF}$         | $V_{IN} = 3.3\text{V}$ , $V_{ADJ} = V_{OUT}$ ,<br>$I_{OUT} = 10\text{mA}$ , $T_A = 25^\circ\text{C}$ | 0.495  | --  | 0.505  | V             |
|                       |                   | $V_{IN} = 3.3\text{V}$ , $V_{ADJ} = V_{OUT}$ ,<br>$I_{OUT} = 10\text{mA}$                            | 0.4925 | --  | 0.5075 |               |
| ADJ Pin Current       | $I_{ADJ}$         | $V_{ADJ} = 0.5\text{V}$  | --     | 20  | 200    | nA            |

| Parameter                          | Symbol          | Test Conditions                            | Min                    | Typ | Max | Unit |   |
|------------------------------------|-----------------|--|------------------------|-----|-----|------|---|
| <b>Enable</b>                      |                 |  |                        |     |     |      |   |
| EN Pin Current                     | I <sub>EN</sub> | V <sub>EN</sub> = 0V, V <sub>IN</sub> = 6V | --                     | 1   | 10  | μA   |   |
| EN Threshold Voltage               | Logic-High      | V <sub>IH</sub>                            | V <sub>IN</sub> = 3.3V | 1.6 | --  | --   | V |
|                                    | Logic-Low       | V <sub>IL</sub>                            | V <sub>IN</sub> = 3.3V | --  | --  | 0.4  |   |
| <b>Over-Temperature Protection</b> |                 |  |                        |     |     |      |   |
| OTP Trip Level                     |                 |  | --                     | 160 | --  | °C   |   |
| Hysteresis                         |                 |  | --                     | 30  | --  | °C   |   |

**Note 1.** Stresses beyond those listed “Absolute Maximum Ratings” may cause permanent damage to the device. These are stress ratings only, and functional operation of the device at these or any other conditions beyond those indicated in the operational sections of the specifications is not implied. Exposure to absolute maximum rating conditions may affect device reliability.

**Note 2.** θ<sub>JA</sub> is measured in the natural convection (air flow = 0 ft/min) at T<sub>A</sub> = 25°C on a highly thermal conductive four-layer test board of JEDEC 51-7 thermal measurement standard. The test board size is 75.6mm x 114.3mm (3"x4.5") with 1.6mm thickness FR4 refer to JEDEC 51 standard. The test board exist four-layer copper, 2oz. (0.07mm) thickness. The case point of θ<sub>JC</sub> is on the expose pad for SOP-8 (Exposed Pad) package. The copper area of top copper plane is about 100mm<sup>2</sup>.

**Note 3.** Devices are ESD sensitive. Handling precaution is recommended.

**Note 4.** The device is not guaranteed to function outside its operating conditions.

## Typical Application Circuit

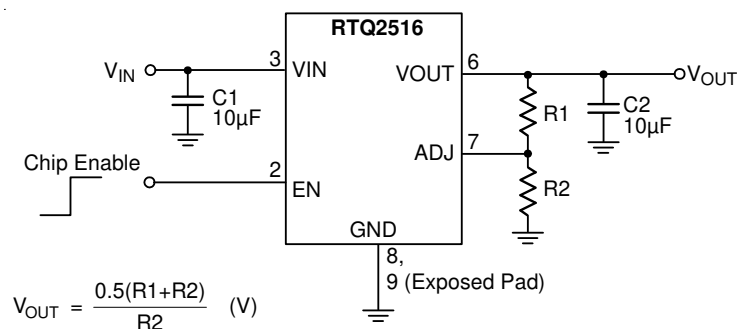

**Typical Operating Characteristics**

**Reference Voltage vs. Temperature**

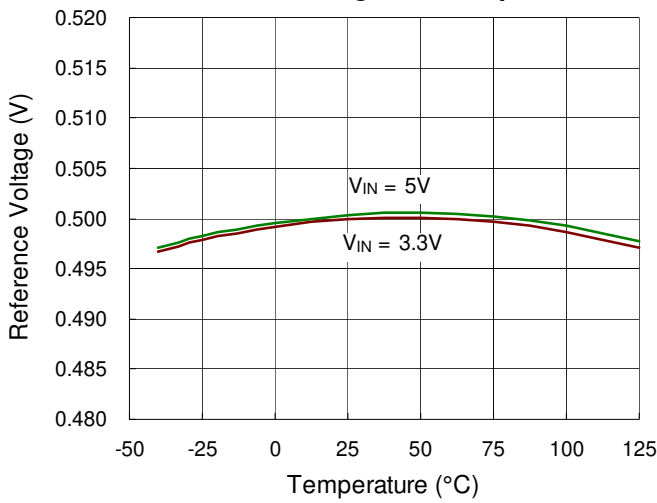

**Quiescent Current vs. Temperature**

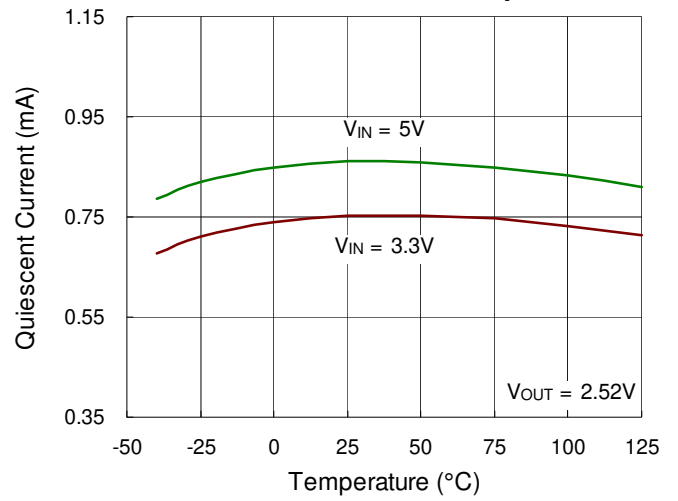

**Shutdown Current vs. Temperature**

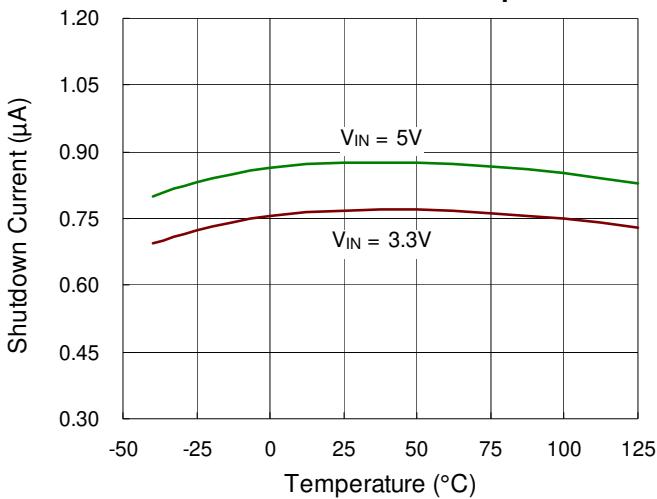

**UVLO vs. Temperature**

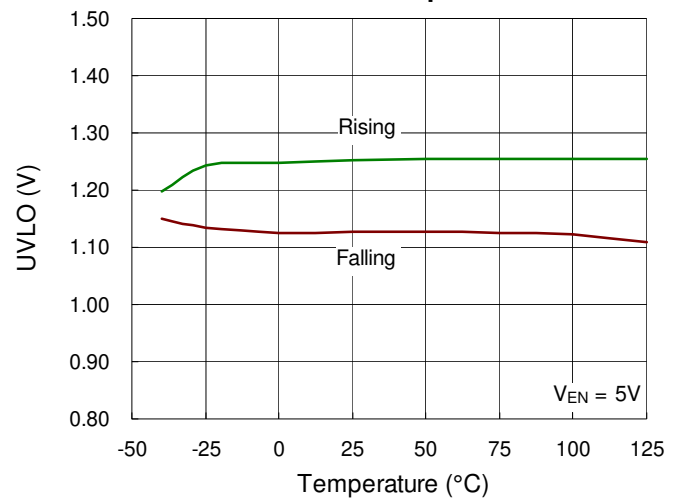

**Dropout Voltage vs. Load Current**

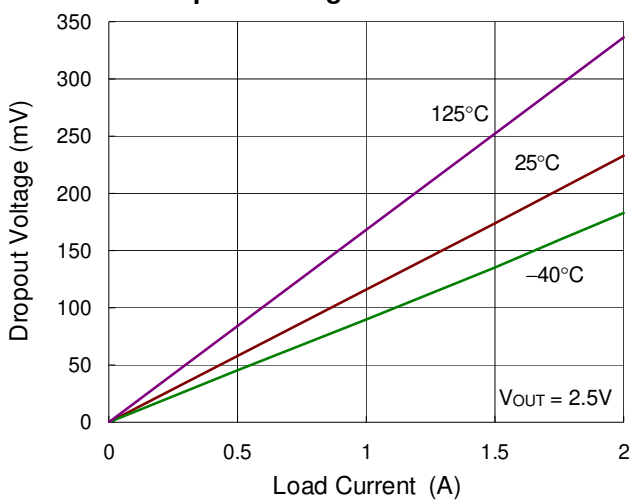

**EN Threshold Voltage vs. Temperature**

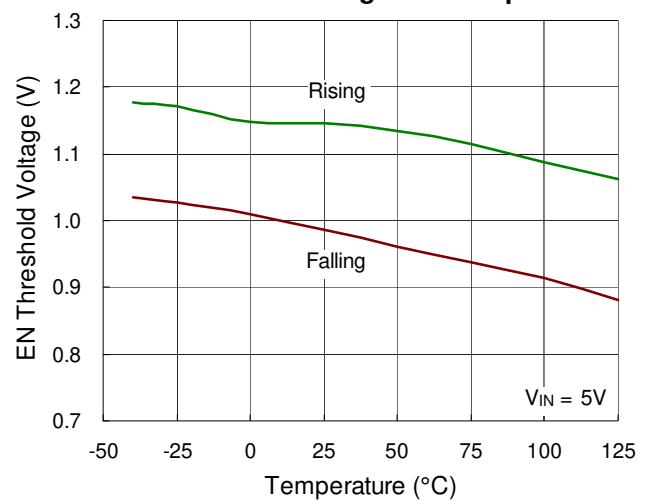

Load Transient Response

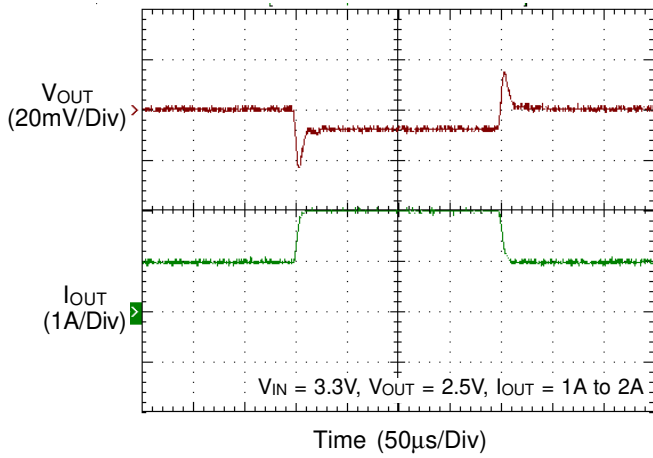

Line Transient Response

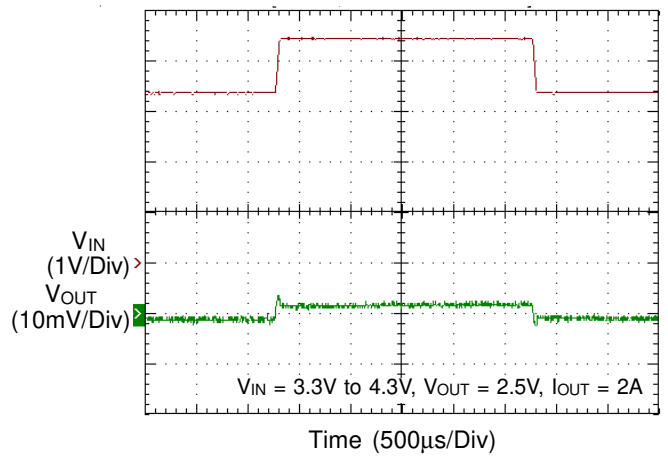

Power On from EN

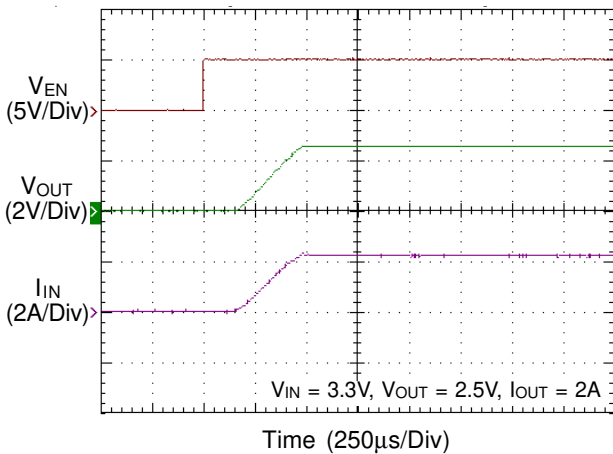

Power Off from EN

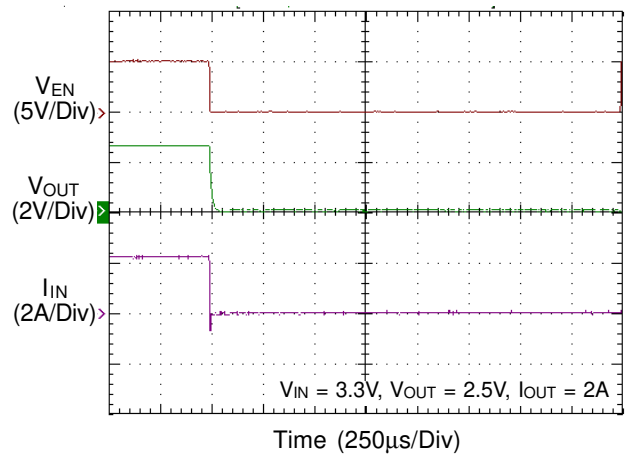

PSRR

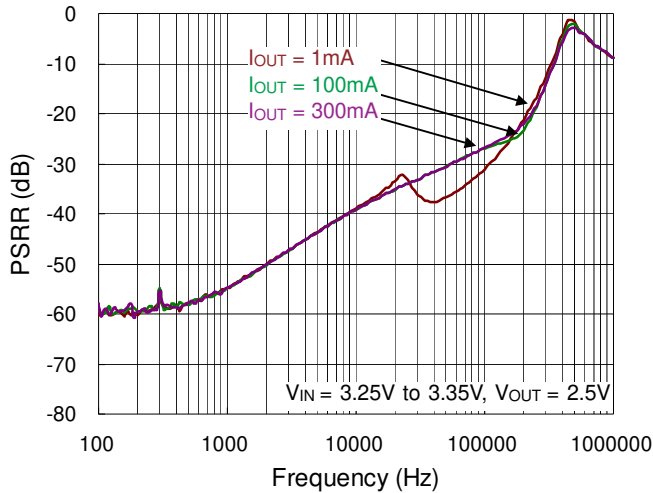

VEN Rising vs. Input Voltage

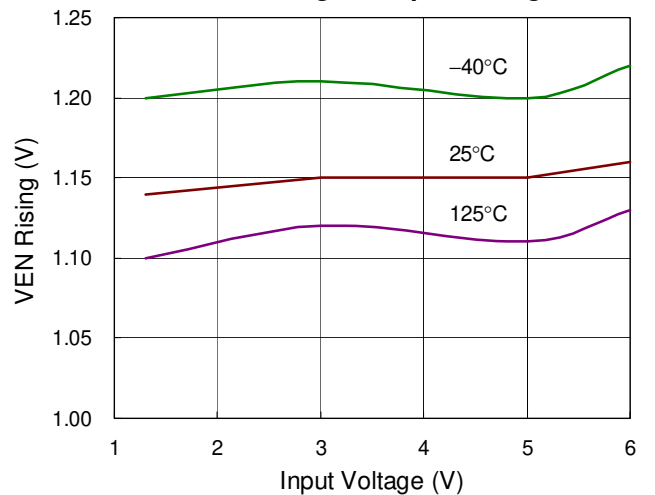



## Application Information

The RTQ2516 is a low voltage, low dropout linear regulator. The input voltage supporting range from 1.4V to 6V and adjustable output voltage from 0.5V to  $(V_{IN} - V_{DROP})$ .

### Output Voltage Setting

The RTQ2516 output voltage is adjustable from 0.5V to  $(V_{IN} - V_{DROP})$  via the external resistive voltage divider. The voltage divider resistors can have values of up to 800kΩ because of the very high impedance and low bias current of the sense comparator. The output voltage is set according to the following equation :

$$V_{OUT} = V_{REF} \times \left(1 + \frac{R1}{R2}\right)$$

where  $V_{REF}$  is the reference voltage with a typical value of 0.5V.

### Chip Enable Operation

The RTQ2516 goes into sleep mode when the EN pin is in a logic low condition. In this condition, the pass transistor, error amplifier, and band gap are all turned off, reducing the supply current to only 10μA (max.). The EN pin can be directly tied to VIN to keep the part on.

### Current Limit

The RTQ2516 contains an independent current limit circuitry, which monitors and controls the pass transistor's gate voltage, limiting the output current to 3A (typ.).

### C<sub>IN</sub> and C<sub>OUT</sub> Selection

The RTQ2516 is designed specifically to work with low ESR ceramic output capacitor for space saving and performance consideration. Using a ceramic capacitor with capacitance range from 10μF to 47μF on the output ensures stability.

Input capacitance is selected to minimize transient input droop during load current steps. For general application, the requirement of input capacitor with a 10μF is recommended to minimize input impedance and provide the desired effect and do not affect stability.

## Thermal Considerations

Thermal protection limits power dissipation in the RTQ2516. When the operation junction temperature exceeds 160°C, the OTP circuit starts the thermal shutdown function and turns the pass element off. The pass element turns on again after the junction temperature cools by 30°C.

The RTQ2516 output voltage will be closed to zero when output short circuit occurs as shown in Figure 1. It can reduce the IC temperature and provides maximum safety to end users when output short circuit occurs.

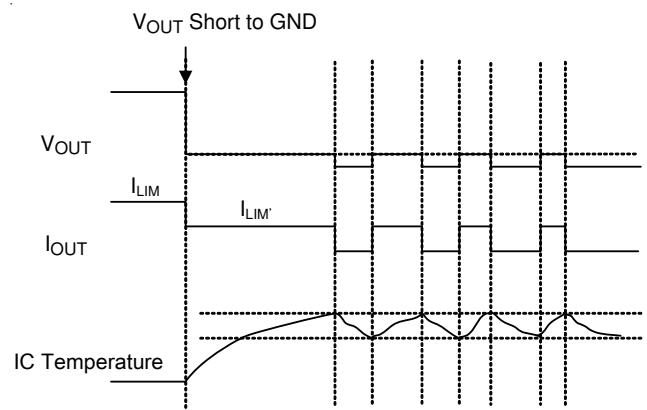

Figure 1. Short Circuit Protection when Output Short Circuit Occurs

The junction temperature should never exceed the absolute maximum junction temperature  $T_{J(MAX)}$ , listed under Absolute Maximum Ratings, to avoid permanent damage to the device. The maximum allowable power dissipation depends on the thermal resistance of the IC package, the PCB layout, the rate of surrounding airflow, and the difference between the junction and ambient temperatures. The maximum power dissipation can be calculated using the following formula :

$$P_{D(MAX)} = (T_{J(MAX)} - T_A) / \theta_{JA}$$

where  $T_{J(MAX)}$  is the maximum junction temperature,  $T_A$  is the ambient temperature, and  $\theta_{JA}$  is the junction-to-ambient thermal resistance.

For continuous operation, the maximum operating junction temperature indicated under Recommended Operating Conditions is 125°C. The junction-to-ambient thermal resistance,  $\theta_{JA}$ , is highly package dependent. For a SOP-

8 (Exposed Pad) package, the thermal resistance,  $\theta_{JA}$ , is  $40^{\circ}\text{C}/\text{W}$  on a standard JEDEC 51-7 high effective-thermal-conductivity four-layer test board. The maximum power dissipation at  $T_A = 25^{\circ}\text{C}$  can be calculated as below :

$$P_{D(\text{MAX})} = (125^{\circ}\text{C} - 25^{\circ}\text{C}) / (40^{\circ}\text{C}/\text{W}) = 2.500\text{W for a SOP-8 (Exposed Pad) package.}$$

The maximum power dissipation depends on the operating ambient temperature for the fixed  $T_{J(\text{MAX})}$  and the thermal resistance,  $\theta_{JA}$ . The derating curves in Figure 2 allows the designer to see the effect of rising ambient temperature on the maximum power dissipation.

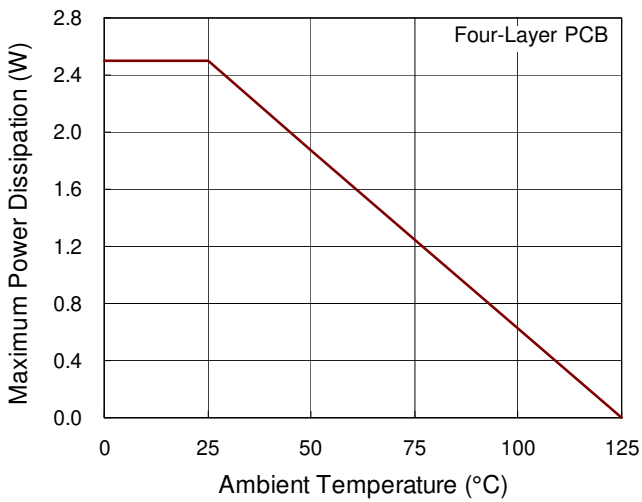
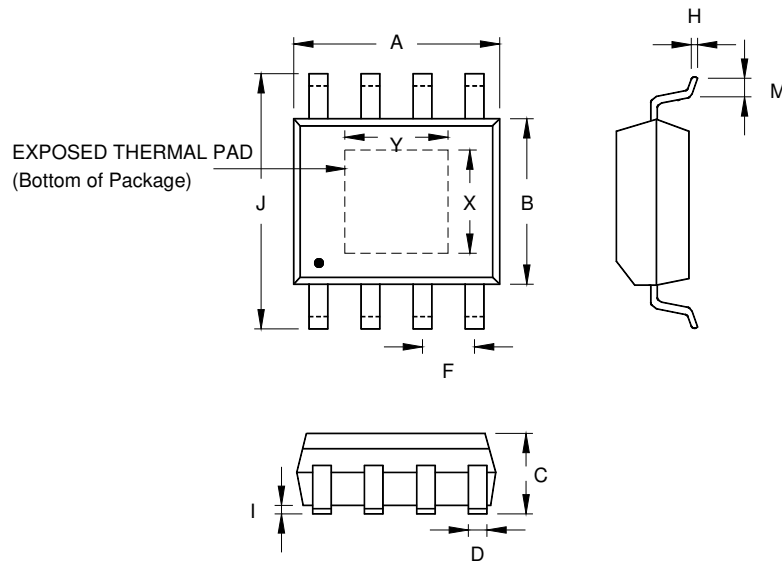

Figure 2. Derating Curve of Maximum Power Dissipation

**Outline Dimension**



| Symbol   | Dimensions In Millimeters |       | Dimensions In Inches |       |       |
|----------|---------------------------|-------|----------------------|-------|-------|
|          | Min                       | Max   | Min                  | Max   |       |
| A        | 4.801                     | 5.004 | 0.189                | 0.197 |       |
| B        | 3.810                     | 4.000 | 0.150                | 0.157 |       |
| C        | 1.346                     | 1.753 | 0.053                | 0.069 |       |
| D        | 0.330                     | 0.510 | 0.013                | 0.020 |       |
| F        | 1.194                     | 1.346 | 0.047                | 0.053 |       |
| H        | 0.170                     | 0.254 | 0.007                | 0.010 |       |
| I        | 0.000                     | 0.152 | 0.000                | 0.006 |       |
| J        | 5.791                     | 6.200 | 0.228                | 0.244 |       |
| M        | 0.406                     | 1.270 | 0.016                | 0.050 |       |
| Option 2 | X                         | 2.100 | 2.500                | 0.083 | 0.098 |
|          | Y                         | 3.000 | 3.500                | 0.118 | 0.138 |

**8-Lead SOP (Exposed Pad) Plastic Package**

Footprint Information

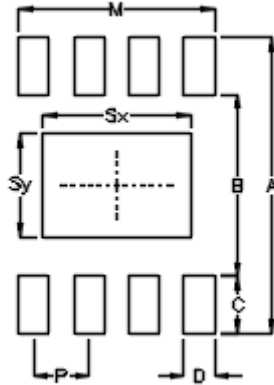

| Package |         | Number of Pin | Footprint Dimension (mm) |      |      |      |      |      |      | Tolerance |       |
|---------|---------|---------------|--------------------------|------|------|------|------|------|------|-----------|-------|
|         |         |               | P                        | A    | B    | C    | D    | Sx   | Sy   |           | M     |
| PSOP-8  | Option1 | 8             | 1.27                     | 6.80 | 4.20 | 1.30 | 0.70 | 2.30 | 2.30 | 4.51      | ±0.10 |
|         | Option2 |               |                          |      |      |      |      | 3.40 | 2.40 |           |       |

**Richtek Technology Corporation**

14F, No. 8, Tai Yuen 1<sup>st</sup> Street, Chupei City  
 Hsinchu, Taiwan, R.O.C.  
 Tel: (8863)5526789

Richtek products are sold by description only. Customers should obtain the latest relevant information and data sheets before placing orders and should verify that such information is current and complete. Richtek cannot assume responsibility for use of any circuitry other than circuitry entirely embodied in a Richtek product. Information furnished by Richtek is believed to be accurate and reliable. However, no responsibility is assumed by Richtek or its subsidiaries for its use; nor for any infringements of patents or other rights of third parties which may result from its use. No license is granted by implication or otherwise under any patent or patent rights of Richtek or its subsidiaries.