

74F675A 16-Bit Serial-In, Serial/Parallel-Out Shift Register

General Description

The 'F675A contains a 16-bit serial in/serial out shift register and a 16-bit parallel out storage register. Separate serial input and output pins are provided for expansion to longer words. By means of a separate clock, the contents of the shift register are transferred to the storage register. The contents of the storage register can also be loaded back into the shift register. A HIGH signal on the Chip Select input prevents both shifting and parallel loading.

- 16-Bit serial I/O shift register
- 16-Bit parallel out storage register
- Recirculating parallel transfer
- Expandable for longer words
- Slim 24 lead package
- 'F675A version prevents false clocking through \overline{CS} or R/\overline{W} inputs

Features

- Serial-to-parallel converter

Ordering Code:

Commercial	Package Number	Package Description
74F675ASPC	N24C	24-Lead (0.300" Wide) Molded Dual-In-Line
74F675APC	N24A	24-Lead (0.600" Wide) Molded Dual-In-Line
74F675ASC (Note 1)	M24B	24-Lead (0.300" Wide) Molded Small Outline, JEDEC

Note 1: Devices also available in 13" reel. Use suffix = SCX.

Logic Symbols

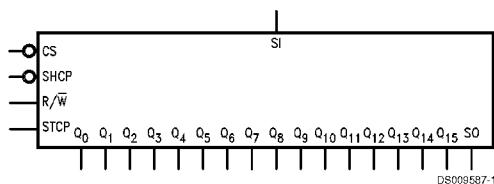

Connection Diagram

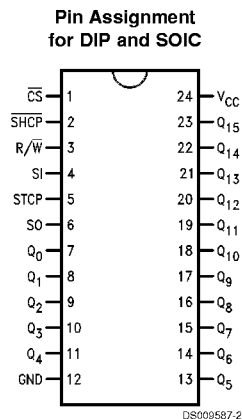

Connection Diagram (Continued)

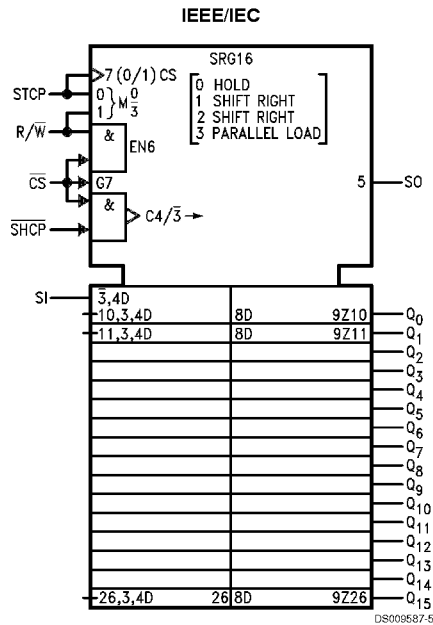

Unit Loading/Fan Out

Pin Names	Description	74F	
		U.L. HIGH/LOW	Input I_{IH}/I_{IL} Output I_{OH}/I_{OL}
SI	Serial Data Input	1.0/1.0	20 μ A/-0.6 mA
\overline{CS}	Chip Select Input (Active LOW)	1.0/1.0	20 μ A/-0.6 mA
\overline{SHCP}	Shift Clock Pulse Input (Active Falling Edge)	1.0/1.0	20 μ A/-0.6 mA
STCP	Store Clock Pulse Input (Active Rising Edge)	1.0/1.0	20 μ A/-0.6 mA
R/\overline{W}	Read/Write Input	1.0/1.0	20 μ A/-0.6 mA
SO	Serial Data Output	50/33.3	-1 mA/20 mA
Q_0-Q_{15}	Parallel Data Outputs	50/33.3	-1 mA/20 mA

Functional Description

The 16-Bit shift register operates in one of four modes, as determined by the signals applied to the Chip Select (\overline{CS}), Read/Write (R/\overline{W}) and Store Clock Pulse (STCP) input. State changes are indicated by the falling edge of the Shift Clock Pulse (\overline{SHCP}). In the Shift Right mode, data enters D_0 from the Serial Input (SI) pin and exits from Q_{15} via the Serial Data Output (SO) pin. In the Parallel Load mode, data from the storage register outputs enter the shift register and serial shifting is inhibited.

The storage register is in the Hold mode when either \overline{CS} or R/\overline{W} is HIGH. With \overline{CS} and R/\overline{W} both LOW, the storage register is parallel loaded from the shift register on the rising edge of STCP.

To prevent false clocking of the shift register, \overline{SHCP} should be in the LOW state during a LOW-to-HIGH transition of \overline{CS} .

To prevent false clocking of the storage register, STCP should be LOW during a HIGH-to-LOW transition of \overline{CS} if R/\overline{W} is LOW, and should also be LOW during a HIGH-to-LOW transition of R/\overline{W} if \overline{CS} is LOW.

Shift Register Operations Table

Control Inputs				Operating Mode
\overline{CS}	R/\overline{W}	\overline{SHCP}	STCP	
H	X	X	X	Hold
L	L	\sim	X	Shift Right
L	H	\sim	L	Shift Right
L	H	\sim	H	Parallel Load, No Shifting

Functional Description (Continued)

Storage Register Operations Table

\overline{CS}	Inputs		Operating Mode
	R/\overline{W}	STCP	
H	X	X	Hold
L	H	X	Hold
L	L	\sim	Parallel Load

H = HIGH Voltage Level
 L = LOW Voltage Level
 X = Immaterial
 \sim = LOW-to-HIGH Transition
 \sim = HIGH-to-LOW Transition

Logic Diagram

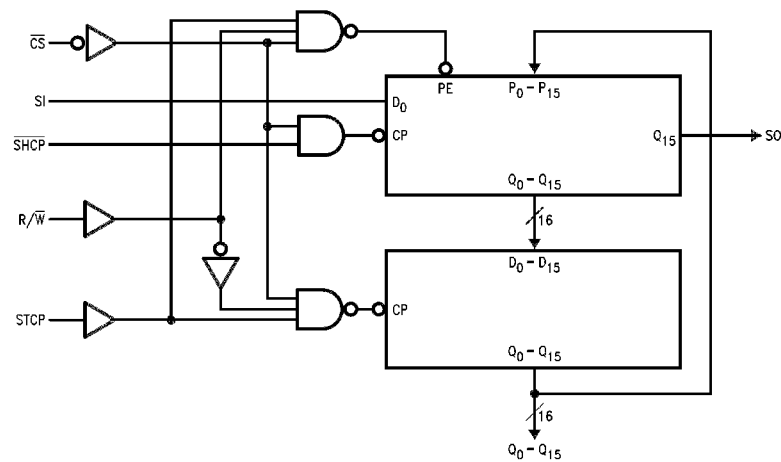

DS009887.4

Please note that this diagram is provided only for the understanding of logic operations and should not be used to estimate propagation delays.

Absolute Maximum Ratings (Note 2)

Storage Temperature	-65°C to +150°C
Ambient Temperature under Bias	-55°C to +125°C
Junction Temperature under Bias	-55°C to +175°C
Plastic	-55°C to +150°C
V _{CC} Pin Potential to Ground Pin	-0.5V to +7.0V
Input Voltage (Note 3)	-0.5V to +7.0V
Input Current (Note 3)	-30 mA to +5.0 mA
Voltage Applied to Output in HIGH State (with V _{CC} = 0V)	
Standard Output	-0.5V to V _{CC}
3-STATE Output	-0.5V to +5.5V

Current Applied to Output in LOW State (Max) twice the rated I_{OL} (mA)

Recommended Operating Conditions

Free Air Ambient Temperature	Commercial	0°C to +70°C
Supply Voltage	Commercial	+4.5V to +5.5V

Note 2: Absolute maximum ratings are values beyond which the device may be damaged or have its useful life impaired. Functional operation under these conditions is not implied.

Note 3: Either voltage limit or current limit is sufficient to protect inputs.

DC Electrical Characteristics

Symbol	Parameter	74F			Units	V _{CC}	Conditions
		Min	Typ	Max			
V _{IH}	Input HIGH Voltage	2.0			V		Recognized as a HIGH Signal
V _{IL}	Input LOW Voltage			0.8	V		Recognized as a LOW Signal
V _{CD}	Input Clamp Diode Voltage			-1.2	V	Min	I _{IN} = -18 mA
V _{OH}	Output HIGH Voltage	74F 10% V _{CC}	2.5		V	Min	I _{OH} = -1 mA
		74F 5% V _{CC}	2.7				I _{OH} = -1 mA
V _{OL}	Output LOW Voltage	74F 10% V _{CC}		0.5	V	Min	I _{OL} = 20 mA
I _{IH}	Input HIGH Current			5.0	μA	Max	V _{IN} = 2.7V
I _{BVI}	Input HIGH Current Breakdown Test	74F		7.0	μA	Max	V _{IN} = 7.0V
I _{CEx}	Output HIGH Leakage Current	74F		50	μA	Max	V _{OUT} = V _{CC}
V _{ID}	Input Leakage Test	74F	4.75		V	0.0	I _{ID} = 1.9 μA All Other Pins Grounded
I _{OD}	Output Leakage Circuit Current	74F		3.75	μA	0.0	V _{IOD} = 150 mV All Other Pins Grounded
I _{IL}	Input LOW Current			-0.6	mA	Max	V _{IN} = 0.5V
I _{OS}	Output Short-Circuit Current		-60	-150	mA	Max	V _{OUT} = 0V
I _{CCH}	Power Supply Current		106	160	mA	Max	V _O = HIGH
I _{CCL}	Power Supply Current		106	160	mA	Max	V _O = LOW

AC Electrical Characteristics

Symbol	Parameter	74F			74F		Units
		$T_A = +25^\circ\text{C}$ $V_{CC} = +5.0\text{V}$ $C_L = 50\text{ pF}$			$T_A, V_{CC} = \text{Com}$ $C_L = 50\text{ pF}$		
		Min	Typ	Max	Min	Max	
f_{max}	Maximum Clock Frequency	100	130		85		MHz
t_{PLH}	Propagation Delay	3.0	8.0	10.5	2.5	12.0	ns
t_{PHL}	STCP to Q_n	3.0	10.5	13.5	2.5	15.0	
t_{PLH}	Propagation Delay	4.0	7.0	9.5	3.5	10.5	ns
t_{PHL}	SHCP to SO	4.5	8.0	10.5	4.0	12.0	

AC Operating Requirements

Symbol	Parameter	74F		74F		Units
		$T_A = +25^\circ\text{C}$ $V_{CC} = +5.0\text{V}$		$T_A, V_{CC} = \text{Com}$		
		Min	Max	Min	Max	
$t_{\text{s}}(\text{H})$	Setup Time, HIGH or LOW	3.5		4.0		ns
$t_{\text{s}}(\text{L})$	$\overline{\text{CS}}$ or $\text{R}/\overline{\text{W}}$ to STCP	5.5		6.5		
$t_{\text{h}}(\text{H})$	Hold Time, HIGH or LOW	0		0		ns
$t_{\text{h}}(\text{L})$	$\overline{\text{CS}}$ or $\text{R}/\overline{\text{W}}$ to STCP	0		0		
$t_{\text{s}}(\text{H})$	Setup Time, HIGH or LOW	3.0		3.5		ns
$t_{\text{s}}(\text{L})$	SI to SHCP	3.0		3.5		
$t_{\text{h}}(\text{H})$	Hold Time, HIGH or LOW	3.0		3.5		ns
$t_{\text{h}}(\text{L})$	SI to SHCP	3.0		3.5		
$t_{\text{s}}(\text{H})$	Setup Time, HIGH or LOW	6.5		7.5		ns
$t_{\text{s}}(\text{L})$	$\text{R}/\overline{\text{W}}$ to SHCP	9.0		10.0		
$t_{\text{h}}(\text{H})$	Hold Time, HIGH or LOW	0		0		ns
$t_{\text{h}}(\text{L})$	$\text{R}/\overline{\text{W}}$ to SHCP	0		0		
$t_{\text{s}}(\text{H})$	Setup Time, HIGH or LOW	7.0		8.0		ns
$t_{\text{s}}(\text{L})$	STCP to SHCP	7.0		8.0		
$t_{\text{h}}(\text{H})$	Hold Time, HIGH or LOW	0		0		ns
$t_{\text{h}}(\text{L})$	STCP to SHCP	0		0		
$t_{\text{s}}(\text{H})$	Setup Time, HIGH or LOW	3.0		3.5		ns
$t_{\text{s}}(\text{L})$	$\overline{\text{CS}}$ to SHCP	3.0		3.5		
$t_{\text{h}}(\text{H})$	Hold Time, HIGH or LOW	3.0		3.5		ns
$t_{\text{h}}(\text{L})$	$\overline{\text{CS}}$ to SHCP	3.0		3.5		
$t_{\text{w}}(\text{H})$	SHCP Pulse Width	5.0		6.0		ns
$t_{\text{w}}(\text{L})$	HIGH or LOW	5.0		6.0		
$t_{\text{w}}(\text{H})$	STCP Pulse Width	6.0		7.0		ns
$t_{\text{w}}(\text{L})$	HIGH or LOW	5.0		6.0		
$t_{\text{s}}(\text{L})$	SHCP to STCP	8.0		9.0		ns
$t_{\text{h}}(\text{H})$	SHCP to STCP	0.0		0.0		ns

Ordering Information

The device number is used to form part of a simplified purchasing code where the package type and temperature range are defined as follows:

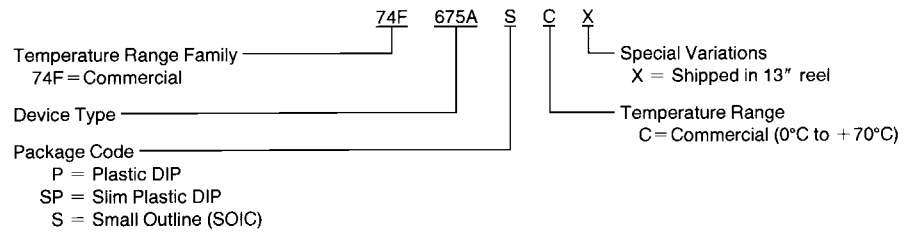

DS009587-6

Physical Dimensions inches (millimeters) unless otherwise noted

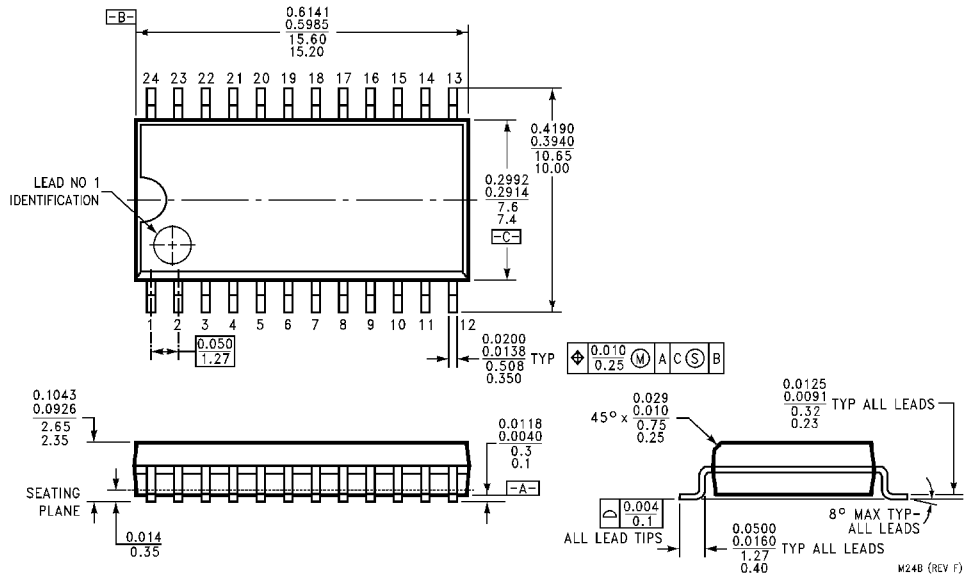

**24-Lead (0.300" Wide) Molded Small Outline Package, JEDEC (S)
Package Number M24B**

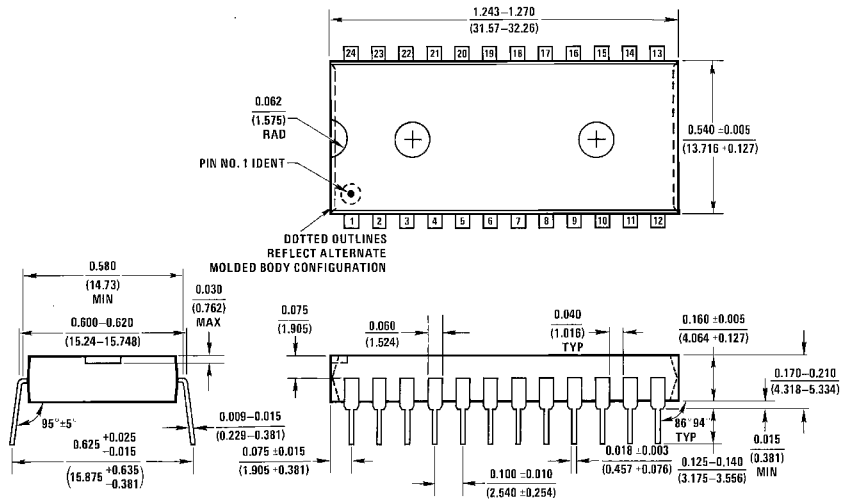

**24-Lead (0.600" Wide) Molded Dual-In-Line Package (P)
Package Number N24A**

Physical Dimensions inches (millimeters) unless otherwise noted (Continued)

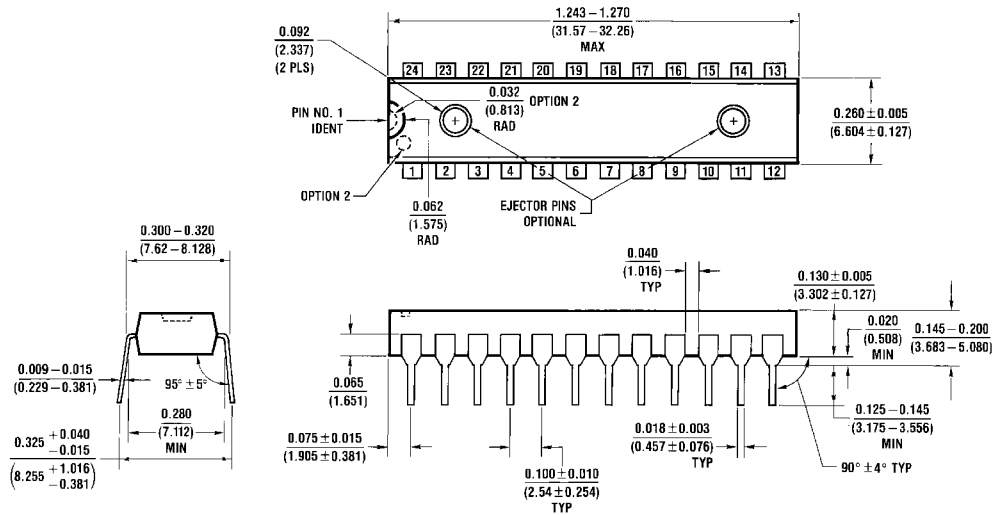

**24-Lead (0.300" Wide) Molded Dual-In-Line Package (SP)
Package Number N24C**

N24C (REV F)

LIFE SUPPORT POLICY

FAIRCHILD'S PRODUCTS ARE NOT AUTHORIZED FOR USE AS CRITICAL COMPONENTS IN LIFE SUPPORT DEVICES OR SYSTEMS WITHOUT THE EXPRESS WRITTEN APPROVAL OF THE PRESIDENT OF FAIRCHILD SEMICONDUCTOR CORPORATION. As used herein:

1. Life support devices or systems are devices or systems which, (a) are intended for surgical implant into the body, or (b) support or sustain life, and (c) whose failure to perform when properly used in accordance with instructions for use provided in the labeling, can be reasonably expected to result in a significant injury to the user.
2. A critical component in any component of a life support device or system whose failure to perform can be reasonably expected to cause the failure of the life support device or system, or to affect its safety or effectiveness.

Fairchild Semiconductor Corporation
Americas
Customer Response Center
Tel: 1-888-522-5372

Fairchild Semiconductor Europe
Fax: +49 (0) 1 80-530 85 86
Email: europe.support@nsc.com
Deutsch Tel: +49 (0) 8 141-35-0
English Tel: +44 (0) 1 793-85-68-56
Italy Tel: +39 (0) 2 57 5631

Fairchild Semiconductor Hong Kong Ltd.
13th Floor, Straight Block,
Ocean Centre, 5 Canton Rd.
Tsimshatsui, Kowloon
Hong Kong
Tel: +852 2737-7200
Fax: +852 2314-0061

National Semiconductor Japan Ltd.
Tel: 81-3-5620-6175
Fax: 81-3-5620-6179

www.fairchildsemi.com