

WLB92 Industrial LED Light Bar (AC Quick Disconnect)



Datasheet

Banner's WLB92 is a very bright LED fixture/luminaire that features an even light output for a no glare 'glow'. The WLB92 series is designed for a wide variety of environments and applications, including but not limited to work stations, machine lighting, and low bay lighting. The WLB92 uses advanced LED lighting technology to provide a high-quality and maintenance free industrial lighting solution.

- Increase worker productivity and ergonomics with bright, high-quality, uniform light
- Exceptionally energy efficient for overall cost savings
- Durable light stands up to your environment with a rugged metal housing and shatter-resistant window
- Easy installation with snap clips
- Intensity can be controlled from 15% to 100% using the attached knob
- Rated for use at 120 V ac in North America
- Rated for use at 100 V ac to 277 V ac outside North America



These AC quick disconnect models can be used as continuous run models that can be cascaded or "daisy-chained" together for a continuous length of lighting using a double-ended accessory cordset (see [Accessories](#) on p. 5). Each light bar can be turned on, off, or dimmed independently of the other lights, upstream or downstream, in the chain.

WLB92 Industrial LED Light Bars are available in several configurations including different lengths and cord options. WLB92 (AC) Daylight White and Warm White models come with a five year, limited warranty. To view or download the latest technical information about this product, including specifications, dimensions, accessories, and wiring, see www.bannerengineering.com.



Important: Read the following instructions before operating the light. Please download the complete WLB92 Industrial LED Light Bar (AC Quick Disconnect) technical documentation, available in multiple languages, from www.bannerengineering.com for details on the proper use, applications, Warnings, and installation instructions of this device.



Important: Lea el siguiente instructivo antes de operar el luminario. Por favor descargue desde www.bannerengineering.com toda la documentación técnica de los WLB92 Industrial LED Light Bar (AC Quick Disconnect), disponibles en múltiples idiomas, para detalles del uso adecuado, aplicaciones, advertencias, y las instrucciones de instalación de estos dispositivos.



Important: Lisez les instructions suivantes avant d'utiliser le luminaire. Veuillez télécharger la documentation technique complète des WLB92 Industrial LED Light Bar (AC Quick Disconnect) sur notre site www.bannerengineering.com pour les détails sur leur utilisation correcte, les applications, les notes de sécurité et les instructions de montage.



Models

Family	Voltage	Cascadable	LED Color	Lighted Length (mm)	Control	Connector	Plug Type (1.8 m cable)
WLB92	Z	C	<input type="checkbox"/>	550	PB	QM	B
	Z = AC	C = Cascadable	Blank = Daylight White WW = Warm White G = Green R = Red Y = Yellow B = Blue	550 1100	PB = Switch, Dimming Knob	QM = Custom Quick Disconnect (QD) *	B = North & Central America, Japan, Taiwan D = India, Sri Lanka, Nepal, Namibia EF = France, Belgium, Slovakia, Tunisia, Germany, Austria, Netherlands, Spain, S. Korea G = UK, Ireland, Cyprus, Malta, Malaysia, Singapore, Hong Kong, Vietnam I = Australia, New Zealand, Papua New Guinea, Argentina, China N = Brazil, South Africa C = AC connector with flying leads Blank = no power cord

* QD models require a mating cordset

Installing the WLB92 Industrial LED Light Bar (AC Quick Disconnect Models)

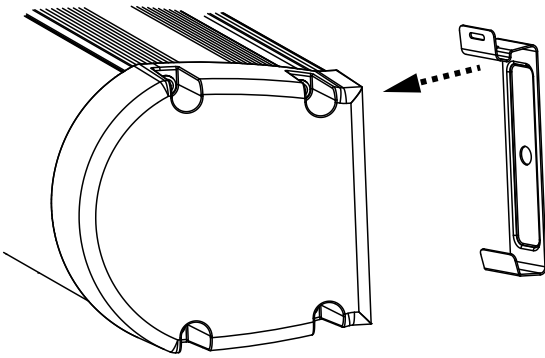

Figure 1. Attaching the snap brackets (step 6)

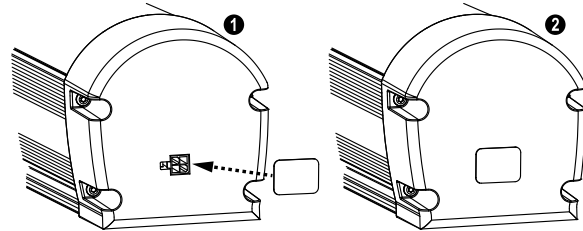

Figure 2. Installing the cascade cover (step 9)

1. Attach the snap brackets to the light.
2. Select a suitable horizontal or vertical dry mounting location. The maximum distance to the power receptacle cannot be farther than the length of the power cord used.
3. Place the light in the mounting location and mark the positions of the snap bracket mounting holes.
4. Remove the brackets from the light.
5. Drill the holes and use appropriate screws to secure the snap bracket to the mounting location.
6. Snap the light onto the brackets.
7. When installing cascading lights, repeat steps 1 through 6 to mount additional lights. See the application note in the *Specifications* section for the maximum cascaded lights and maximum allowed cable run when choosing mounting locations.
8. Connect the cascaded lights together using an applicable cordset (see [Accessories](#) on p. 5).
9. Install the supplied cover over the output connector on the last light in the chain.
10. Plug the power cord from the first light into the wall outlet. A 3 m (10 ft) cord is available for applications requiring a longer cord for cabinet installations.



CAUTION: To reduce the risk of fire, electrical shock, or injury to personal:

- Use only insulated staples or plastic ties to secure cords
- Route and secure cords so that they will not be pinched or damaged when the cabinet is pushed to the wall
- Position the portable cabinet light with respect to the cabinet so the lamp replacement markings are able to be read during relamping
- Do not recess into ceilings or soffits
- Do not conceal the cords. The National Electrical Code (NEC) does not permit cords to be concealed where damage to insulation may go unnoticed. To prevent fire danger, do not run cords behind walls, ceilings, soffits, or cabinets where it may be inaccessible for examination. Cords should be visually examined periodically and immediately replaced when any damage is noted.



CAUTION: To Reduce the Risk of Fire. Do not install the 550 mm models in a compartment smaller than 305 mm by 305 mm by 675 mm. Do not install the 1100 mm models in a compartment smaller than 305 mm by 305 mm by 1350 mm.

Specifications

Supply Voltage

Nominal voltage: 120 V ac, 60 Hz in North America
Nominal voltage: 100 V ac to 277 V ac, 50/60 Hz outside North America
Power factor: > 0.95 at 120 V ac and > 0.90 at 230 V ac
Total harmonic distortion (THD): < 20%
 See electrical characteristics on product label

Supply Current

Lighted Length (mm)	Max. Current Draw (A) at 90 V ac	Typical Current Draw (A)	
		120 V ac	230 V ac
550	0.425	0.270	0.135
1100	0.850	0.540	0.250

Supply Protection Circuitry

Protected against transient voltages

Light Characteristics

Daylight White and Warm White Efficacy: 110 lumens/watt typical at 120 V ac at 25 °C (77 °F)
 CRI: 82, typical

Color	Dominant Wavelength (nm) or Color Temperature (CCT)	Lighted Length Lumens (Typical at 25 °C)	
		550 mm	1100 mm
Daylight White	5000 K (±300 K)	3510	7150
Warm White	3000 K (+225 K, -125 K)	3510	7150
Green	525 nm	1430	2975
Red	625 nm	745	1545
Yellow	590 nm	620	1295
Blue	470 nm	405	840

Test Data

LM-79, LM-80, TM-21

Environmental Rating

IEC IP40

LED Lifetime

Lumen Maintenance - L₇₀
 When operating within specifications, output will decrease less than 30% after 50,000 hours.

Switch/Dimming Knob

On/Off Switch and dimming knob, dimmable to 15% intensity

Construction

Anodized aluminum housing, polycarbonate window and end caps, and stainless steel mounting brackets

Spacing Criterion

Vertical: 1.20
Horizontal: 1.32

Connections

Integral custom quick disconnect (connecting cordset required)

Mounting

Snap mount brackets included (two for the 550 mm model; three for the 1100 mm model)
 Compatible with integral 45 mm aluminum framing mounting slots

Operating Temperature

550 Lighted Length: -35 °C to +50 °C (-31 °F to +122 °F) for 24 hours per day for 5 years of operation
1100 Lighted Length: -40 °C to +45 °C (-40 °F to +113 °F) for 16 hours per day for 5 years of operation; or -40 °C to +35 °C (-40 °F to +95 °F) for 24 hours per day for 5 years of operation

Storage Temperature

-40 °C to +70 °C (-40 °F to +158 °F)

Vibration and Mechanical Shock

Vibration: 10 Hz to 55 Hz, 0.5 mm peak-to-peak amplitude per IEC 60068-2-6
 Shock: 5G 11 ms duration, half sine wave per IEC 60068-2-27

Application Notes

When connecting continuous run/cascadable lights in series, see table for maximum number of units. Do not exceed a maximum wiring distance of 100 m (328 ft) in the main power cable and any cascading cables.

Maximum Unit Limit (when using both model lengths)	
550 mm Lights	1100 mm Lights
10	0
8	1
6	2
4	3
2	4
0	5

For example, if you use four 550 mm lights, you may add up to three 1100 mm lights within the same continuous run.

Certifications



Spacing Criteria (SC)

The spacing criteria is the fixture-spacing-to-mounting-height ratio and aids in laying out a pattern of fixtures. Multiply the spacing criteria by the mounting height to get the maximum fixture spacing that still provides even illumination (no shadowing between fixtures).

$\text{Luminaire Spacing} = \text{SC} \times \text{Height to Illuminated Plane}$

The mounting height is the distance from the fixture to the surface you are lighting.

Performance Curves

550 mm Models - Daylight White and Warm White

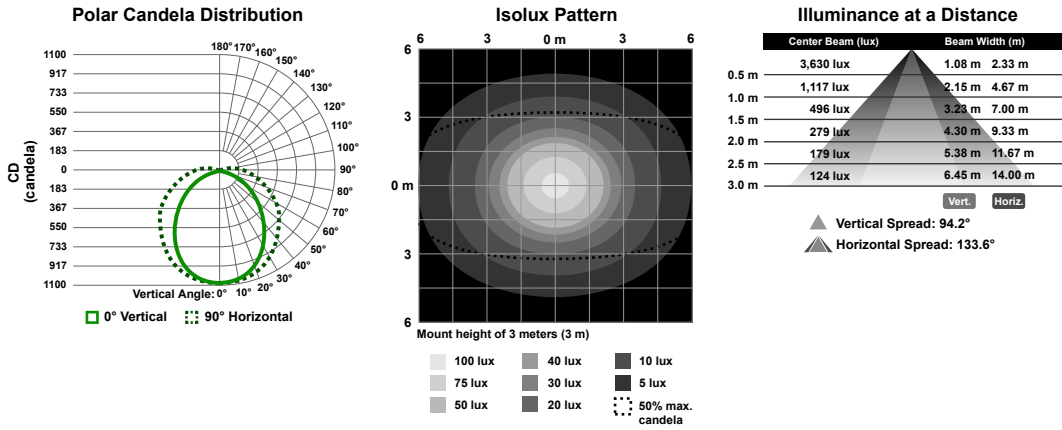

1100 mm Models - Daylight White and Warm White

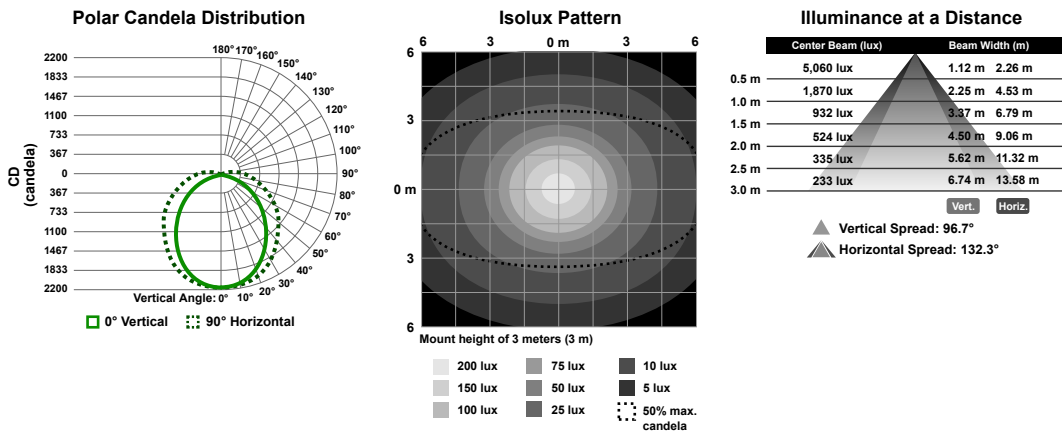

Dimensions



Model	L1	L2
WLB92ZC...550PBQM	543 mm (21.4 in)	651 mm (25.6 in)
WLB92ZC...1100PBQM	1098 mm (43.2 in)	1206 mm (47.5 in)

Accessories

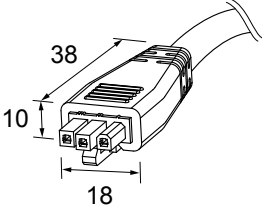
Wall Plug Cordsets					
Model	Plug Type	Countries	Wire Gauge	Length	Dimensions
LQMAC-306	Flying Leads		18 AWG	1.8 m (6 ft)	
LQMAC-306B	NEMA 5-15 grounded (IEC Type B)	United States, Canada, Japan, Puerto Rico, Taiwan			
LQMAC-306D	BS 546 (IEC Type D)	India			
LQMAC-306EF	CEE 7/7 (IEC Type E or F)	Germany, France, South Korea, The Netherlands, Poland, Spain, Turkey			
LQMAC-306G	BS 1363 (IEC Type G)	United Kingdom, Ireland, Singapore, Vietnam			
LQMAC-306I	AS/NZS 3112 (IEC Type I)	China, Australia, New Zealand			
LQMAC-306N	NBR 14136 (IEC Type N)	Brazil			
LQMAC-310B	NEMA 5-15 grounded (IEC Type B)	United States, Canada, Japan, Puerto Rico, Taiwan		3 m (10 ft)	

For other lengths of the LQMAC-306 cables, contact the factory. LQMAC-310B is available for applications requiring a 3 m (10 ft) cord for cabinet installation. For complete listing of countries and wall plug types, see the IEC World Plugs website.

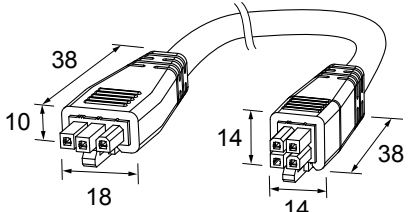
Continuous Run/Cascade Cordsets					
Model	Length	Style	Wire Gauge	Dimensions	
LQMAEC-3005SS	0.15 m (0.5 ft)	Male straight/Male straight	18 AWG		
LQMAEC-301SS	0.31 m (1 ft)				
LQMAEC-303SS	0.91 m (3 ft)				
LQMAEC-306SS	1.83 m (6 ft)				
LQMAEC-312SS	3.66 m (12 ft)				
LQMAEC-320SS	6.1 m (20 ft)				
LQMAEC-330SS	9.14 m (30 ft)				

Brackets

LMBWLB92CLIP

- Snap clip allows for tool-less installation
- Stainless steel
- Includes four snap clips, four screws, and two insulator caps

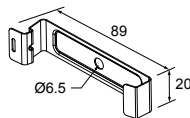

The LMBWLB92CLIP bracket replaces the bracket that ships with the WLB92 light.

Banner Engineering Corp. Limited Warranty

Banner Engineering Corp. warrants its products to be free from defects in material and workmanship for five years on daylight white and warm white models and one year on all other models following the date of shipment. Banner Engineering Corp. will repair or replace, free of charge, any product of its manufacture which, at the time it is returned to the factory, is found to have been defective during the warranty period. This warranty does not cover damage or liability for misuse, abuse, or the improper application or installation of the Banner product.

THIS LIMITED WARRANTY IS EXCLUSIVE AND IN LIEU OF ALL OTHER WARRANTIES WHETHER EXPRESS OR IMPLIED (INCLUDING, WITHOUT LIMITATION, ANY WARRANTY OF MERCHANTABILITY OR FITNESS FOR A PARTICULAR PURPOSE), AND WHETHER ARISING UNDER COURSE OF PERFORMANCE, COURSE OF DEALING OR TRADE USAGE.

This Warranty is exclusive and limited to repair or, at the discretion of Banner Engineering Corp., replacement. **IN NO EVENT SHALL BANNER ENGINEERING CORP. BE LIABLE TO BUYER OR ANY OTHER PERSON OR ENTITY FOR ANY EXTRA COSTS, EXPENSES, LOSSES, LOSS OF PROFITS, OR ANY INCIDENTAL, CONSEQUENTIAL OR SPECIAL DAMAGES RESULTING FROM ANY PRODUCT DEFECT OR FROM THE USE OR INABILITY TO USE THE PRODUCT, WHETHER ARISING IN CONTRACT OR WARRANTY, STATUTE, TORT, STRICT LIABILITY, NEGLIGENCE, OR OTHERWISE.**

Banner Engineering Corp. reserves the right to change, modify or improve the design of the product without assuming any obligations or liabilities relating to any product previously manufactured by Banner Engineering Corp. Any misuse, abuse, or improper application or installation of this product or use of the product for personal protection applications when the product is identified as not intended for such purposes will void the product warranty. Any modifications to this product without prior express approval by Banner Engineering Corp will void the product warranties. All specifications published in this document are subject to change; Banner reserves the right to modify product specifications or update documentation at any time. Specifications and product information in English supersede that which is provided in any other language. For the most recent version of any documentation, refer to: www.bannerengineering.com.

For patent information, see www.bannerengineering.com/patents.

FCC Part 15 and CAN ICES-3 (B)/NMB-3(B)

This device complies with part 15 of the FCC Rules and CAN ICES-3 (B)/NMB-3(B). Operation is subject to the following two conditions:

1. This device may not cause harmful interference, and
2. This device must accept any interference received, including interference that may cause undesired operation.

This equipment has been tested and found to comply with the limits for a Class B digital device, pursuant to part 15 of the FCC Rules and CAN ICES-3 (B)/NMB-3(B). These limits are designed to provide reasonable protection against harmful interference in a residential installation. This equipment generates, uses and can radiate radio frequency energy and, if not installed and used in accordance with the instructions, may cause harmful interference to radio communications. However, there is no guarantee that interference will not occur in a particular installation. If this equipment does cause harmful interference to radio or television reception, which can be determined by turning the equipment off and on, the user is encouraged to try to correct the interference by one or more of the following measures:

- Reorient or relocate the receiving antenna.
- Increase the separation between the equipment and receiver.
- Connect the equipment into an outlet on a circuit different from that to which the receiver is connected.
- Consult the manufacturer.

Mexican Importer

Banner Engineering de México, S. de R.L. de C.V.
David Alfaro Siqueiros 103 Piso 2 Valle oriente
San Pedro Garza Garcia Nuevo León, C. P. 66269
81 8363.2714



more sensors, more solutions