

Description

The AL8116 is a flexible dimming signal interface controller that can convert the three different inputs of dimmer type including 0 to 10V DC linear dimming, 0 to 100% duty cycle PWM (pulse width modulation) signal and a simple resistive potentiometer to an output PWM signal. It is easy to provide an isolation dimming control via an opto-coupler to the primary side LED driver.

The AL8116 has a wide input voltage range from 10V to 56V. The DIM pin of the AL8116 can output an adjustable accurate bias current that make it suit for both active and passive 0 to 10V dimmers, meanwhile potentiometers. The AL8116 output duty cycle accuracy is typically $\pm 2.5\%$ and the minimum output duty cycle can be set through the CLAMP pin resistor.

The AL8116 has an internal auto-recoverable over-temperature-protection.

The AL8116 is available in SOT26 (Type CJ) package to minimize PCB space as well as external component count.

Features

- Wide VCC Operating Range 10V to 56V
- Low Operation Current (Typical 600 μ A)
- Precision Dimmer Type with
 - Voltage Potential: 0/1V to 10V
 - PWM Dimming: 0.2k to 10kHz
 - Potentiometer: 0 to 100k Ω
- Adjustable Bias Current Source of DIM Pin
- Accurate Output Duty Cycle Tolerance $\pm 2.5\%$
- Adjustable Minimum Output PWM Duty Clamping: 8%, 6%, 4%, and 2%
- Built-In Over Temperature Protection for Chip
- **Totally Lead-Free & Fully RoHS Compliant (Notes 1 & 2)**
- **Halogen and Antimony Free. "Green" Device (Note 3)**
- **For automotive applications requiring specific change control (i.e. parts qualified to AEC-Q100/101/200, PPAP capable, and manufactured in IATF 16949 certified facilities), please [contact us](mailto:contact@diodes.com) or your local Diodes representative. <https://www.diodes.com/quality/product-definitions/>**

- Notes:
1. No purposely added lead. Fully EU Directive 2002/95/EC (RoHS), 2011/65/EU (RoHS 2) & 2015/863/EU (RoHS 3) compliant.
 2. See <https://www.diodes.com/quality/lead-free/> for more information about Diodes Incorporated's definitions of Halogen- and Antimony-free, "Green" and Lead-free.
 3. Halogen- and Antimony-free "Green" products are defined as those which contain <900ppm bromine, <900ppm chlorine (<1500ppm total Br + Cl) and <1000ppm antimony compounds.

Pin Assignments

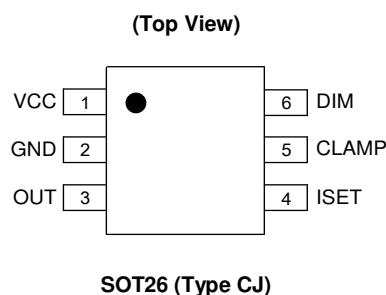

Applications

- 0 to 10V Dimming Luminaires
- Dimmable LED Power Supply
- Dimming Control Devices
- Commercial LED Lighting
- Smart LED Lighting

Typical Applications Circuit

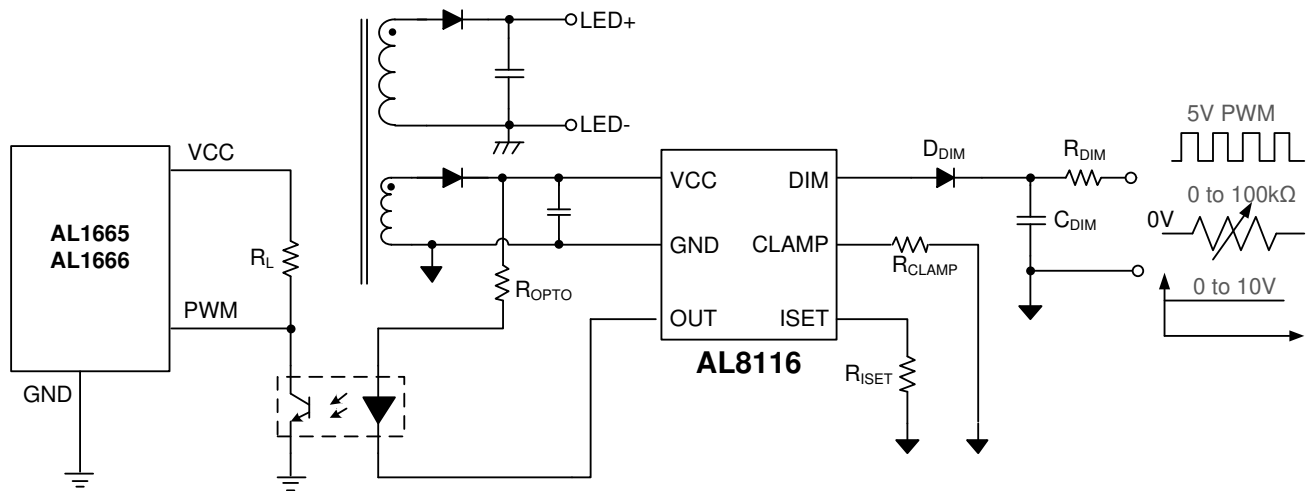

Figure 1. AL8116 Typical Application Circuit

Pin Descriptions

Pin Number	Pin Name	Function
1	VCC	Supply voltage pin.
2	GND	Ground or Power return pin.
3	OUT	This pin is dimming output. It's an open-drain configuration. Connect this pin to power supply by a resistor.
4	ISET	This pin is used to set bias current of DIM pin by a resistor (R _{ISET}) connected between this pin and GND.
5	CLAMP	This pin is used to set minimum output clamped duty cycle by a resistor (R _{CLAMP}) connected between this pin and GND.
6	DIM	Dimming signal input; - Voltage Potential: 0/1V to 10V - PWM Dimming: 0.2k to 10kHz and amplitude is upper 3.2V - Potentiometer: 0 to 100kΩ

Functional Block Diagram

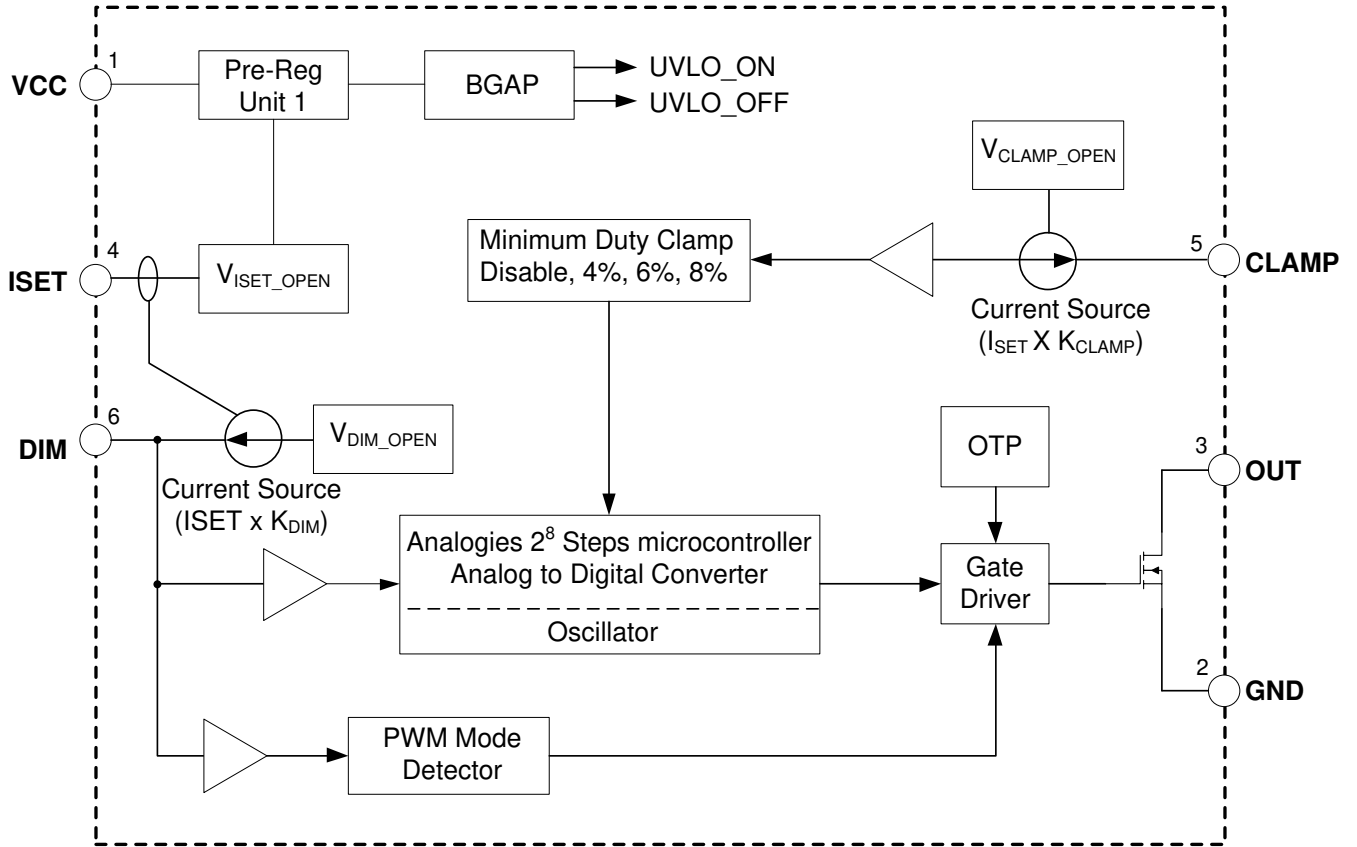

Figure 2. AL8116 Functional Block Diagram

Absolute Maximum Ratings (@T_A = +25°C, unless otherwise specified.) (Note 4)

Symbol	Parameter	Rating	Unit
V _{CC}	Voltage at VCC Pin	-0.3 to +60	V
V _{OUT}	Voltage at OUT Pin	-0.3 to +60	V
I _{OUT}	OUT Sink Current	30	mA
V _{DIM}	Voltage at DIM Pin	-0.3 to +20	V
V _{ISET} , V _{CLAMP}	Voltages at ISET, CLAMP Pins	-0.3 to +6	V
T _{LEAD}	Lead Temperature (Soldering, 10s)	+260	°C
T _J	Operating Junction Temperature	-40 to +150	°C
T _{ST}	Storage Temperature	-65 to +150	°C
—	ESD (Human Body Model)	2.5	kV
—	ESD (Charged-Device Model)	1000	V

Thermal Information (Note 5)

Package	θ_{JC} Thermal Resistance Junction-to-Case	θ_{JA} Thermal Resistance Junction-to-Ambient	P _D T _A = +85°C
SOT26 (Type CJ)	60°C/W	240°C/W	200mW

Recommended Operating Conditions (@T_A = +25°C, unless otherwise specified.) (Note 6)

Symbol	Parameter	Min	Max	Unit
V _{CC}	Supply VCC Voltage	10	56	V
V _{OUT}	Input Voltage on OUT Pin	—	56	V
T _J	Operating Junction Temperature	-40	+125	°C
R _{ISET}	Resistor of ISET Pin	33	330	kΩ
I _{DIM_SOURCE}	Source Current of DIM Pin	—	300	μA
V _{DIM}	Input Voltage of DIM Pin	0	13	V
f _{DIM}	Input PWM Frequency of DIM Pin	0.5	5	kHz
C _{DIM}	Capacitor of DIM Pin (C _{DIM}) (Note 7)	330	1000	pF
R _{DIM}	Resistance of DIM Pin (R _{DIM}) (Note 7)	1	6.5	kΩ
—	PWM Signal Input Rising and Falling Time Rate	3	—	V/μs
V _{DIM_PWM_H}	High Voltage Level PWM Signal Input on DIM Pin	3.2	13	V
V _{DIM_PWM_L}	Low Voltage Level PWM Signal Input on DIM Pin	—	1.2	V
I _{OUT_SINK}	Sink Current of OUT Pin	—	20	mA
T _A	Ambient Temperature	-40	+105	°C

- Notes:
- Stresses greater than those listed under *Absolute Maximum Ratings* can cause permanent damage to the device. These are stress ratings only, and functional operation of the device at these or any other conditions beyond those indicated under *Recommended Operating Conditions* is not implied. Exposure to *Absolute Maximum Ratings* for extended periods can affect device reliability. All voltages unless otherwise stated and measured with respect to GND.
 - Test condition: device mounted on 1" × 1" FR-4 substrate PCB, 2oz copper, with minimum recommended pad layout.
 - It's essential to connect VCC pin with a SMD ceramic capacitor (0.1μF to 0.47μF) to filter out the undesired switching noise for stable operation. This capacitor should be placed as close to IC as possible.
 - Test condition is R_{ISET} = 100kΩ. (This mean is I_{DIM} = 100μA).

Electrical Characteristics ($V_{CC} = 32V @ T_A = +25^{\circ}C$, unless otherwise specified.)

Symbol	Parameter	Conditions	Min	Typ	Max	Unit
Supply Voltage (VCC Pin)						
V _{CC_ON}	UVLO(ON)	V _{CC} Startup Threshold	6.0	7.0	8.0	V
V _{CC_OFF}	UVLO(OFF)	V _{CC} Minimum Operating Voltage	5.2	6.0	6.8	V
I _{VCC}	Operating Current	R _{ISET} = 100kΩ, DIM Pin and CLAMP Pin are Floating.	—	600	850	μA
ISET Pin						
V _{ISET_OPEN}	Open Voltage	ISET Pin is Floating.	2.45	2.5	2.55	V
K _{DIM}	Current Ratio of I _{DIM} to I _{SET} (Calculate I _{DIM} / I _{SET})	—	—	4	—	—
K _{CLAMP}	Current Ratio of I _{CLAMP} to I _{SET} (Calculate I _{CLAMP} / I _{SET})	—	—	0.4	—	—
DIM Pin (Dimming Function)						
V _{DIM_OPEN}	Open Voltage	R _{ISET} = 100kΩ, DIM Pin is Floating.	12.2	13	13.8	V
V _{DIM_MAX_ON}	Maximum Voltage on Level	Output Duty = 100%	10.07	10.27	10.47	V
V _{DIM_Zero_ON}	Zero Duty On OUT Pin	Output Duty ≤ 1%	—	1.5	—	V
I _{DIM_100}	Bias Current	R _{ISET} = 100kΩ	97.5	100.5	103.5	μA
V _{DIM_PWM_H}	High Level of PWM Input Signal	(Note 8)	3.2	—	—	V
V _{DIM_PWM_L}	Low Level of PWM Input Signal	(Note 8)	—	—	1.2	V
—	PWM Dimming Mode Setting	Trigger Rising Rate and Continuous 8 Times. (Note 8)	3	—	—	V/μs
V _{DIM_OFF}	Cut-Off Level Voltage	Output Duty = 0%	1.23	1.3	1.37	V
V _{DIM_OFF_HYS}	Cut-Off Recovery Hysteresis Voltage	Output Duty ≥ 0%	—	0.1	—	V
CLAMP Pin (Clamping Minimum Dimming)						
V _{CLAMP_OPEN}	Open Voltage	R _{ISET} = 100kΩ, CLAMP Pin is Floating.	4.7	5.0	5.3	V
D _{OUT_0%}	Minimum Duty Cycle Clamp When R _{ISET} = 100kΩ	R _{CLAMP} ≥ 1MΩ or Open V _{CLAMP} ≥ 4.2V and V _{DIM} = 1.65V	1	2	4	%
D _{OUT_4%}		R _{CLAMP} = 300kΩ V _{CLAMP} = 2.6V to 3.6V and V _{DIM} = 1.5V	2	4	6	%
D _{OUT_6%}		R _{CLAMP} = 150kΩ V _{CLAMP} = 1V to 2V and V _{DIM} = 1.5V	4	6	8	%
D _{OUT_8%}		R _{CLAMP} = 0Ω V _{CLAMP} ≤ 0.5V and V _{DIM} = 1.5V	6	8	10	%
Open Drain Output Set (OUT Pin)						
V _{OUT_LOW}	Output Low Level	@2mA Sink Current	—	—	200	mV
D. A	Dimming Accuracy of Duty (Chip to Chip)	During DIM Voltage is from 2V to 9V. (Note 8)	-2.5	—	+2.5	%
f _{OUT}	Output Frequency	—	1.0	1.5	2.0	kHz
Internal OTP (Over Temperature Protection)						
OTP	OTP Trip Level	(Note 8)	—	+135	—	°C
ΔOTP	OTP Hysteresis	(Note 8)	—	+20	—	°C

Note: 8. These parameters, although guaranteed by design, are not 100% tested in production.

Performance Characteristics

V_{CC_ON} vs. Ambient Temperature

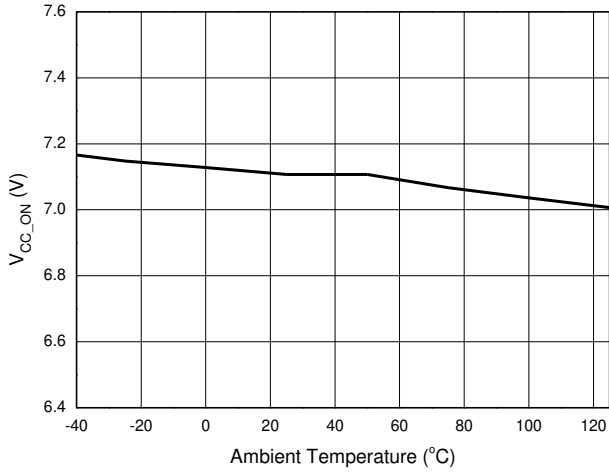

V_{CC_OFF} vs. Ambient Temperature

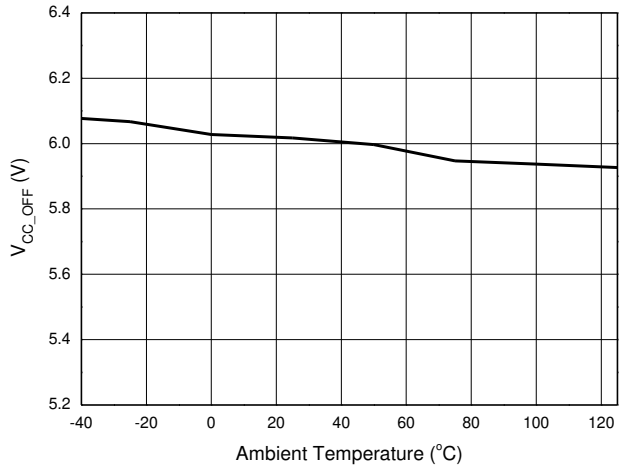

I_{CC_16V} Current vs. Ambient Temperature

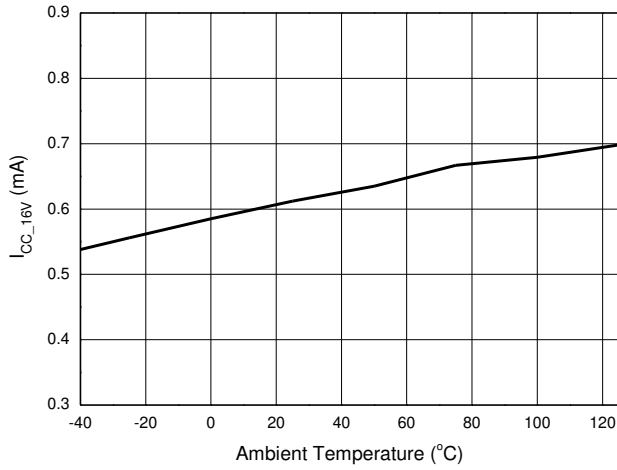

V_{ISET_OPEN} vs. Ambient Temperature

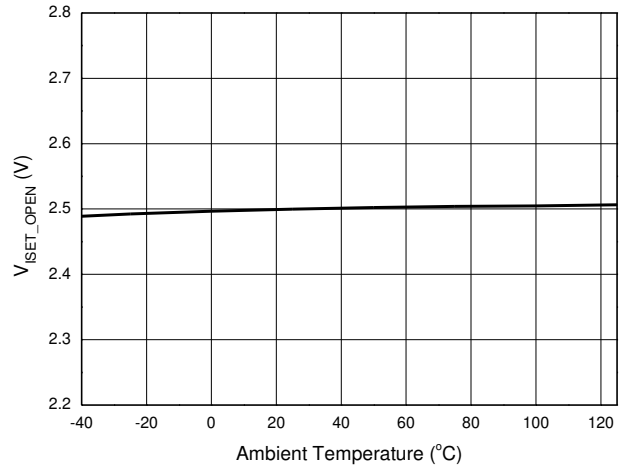

V_{DIM_OPEN} vs. Ambient Temperature

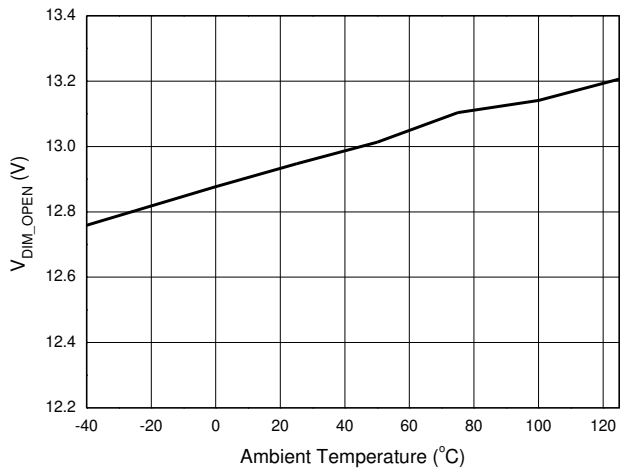

V_{DIM_MAX_ON} vs. Ambient Temperature

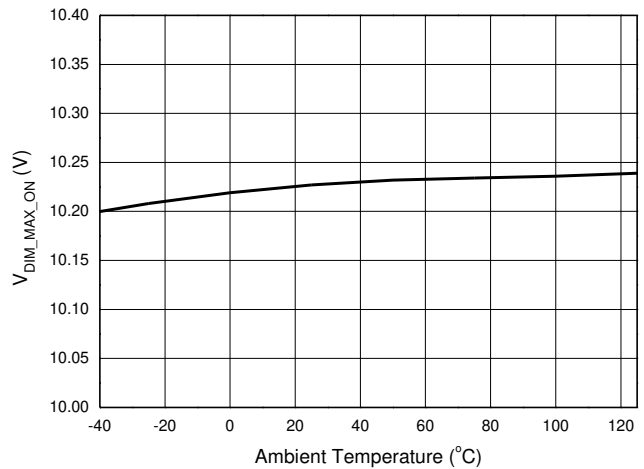

Performance Characteristics (continued)

I_{DIM_100} vs. Ambient Temperature

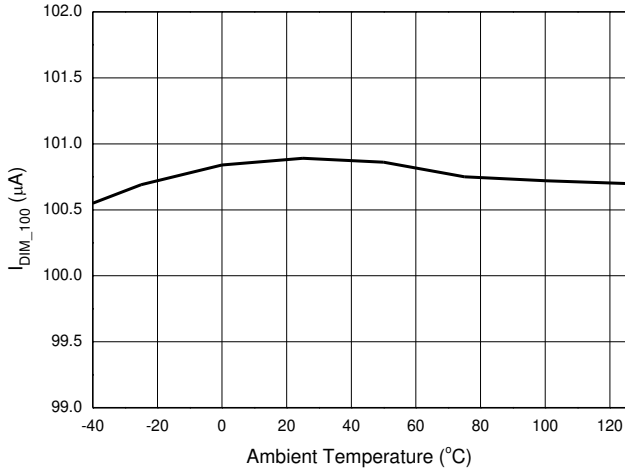

V_{CLAMP_OPEN} vs. Ambient Temperature

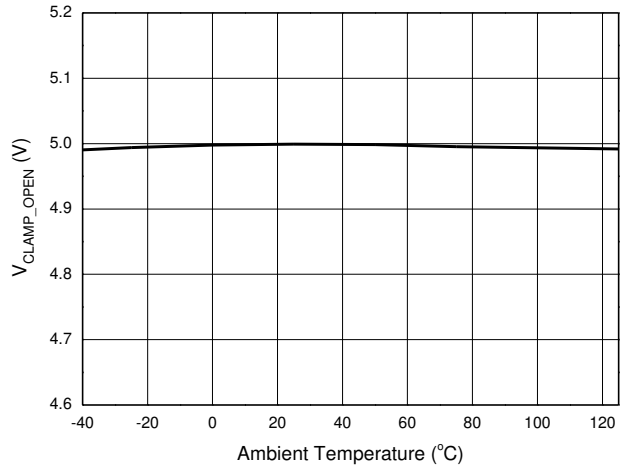

V_{DIM_OFF} vs. Ambient Temperature

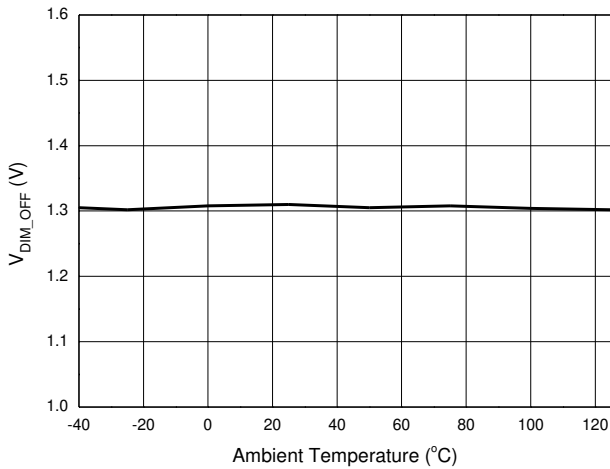

V_{DIM_OFF_HYS} vs. Ambient Temperature

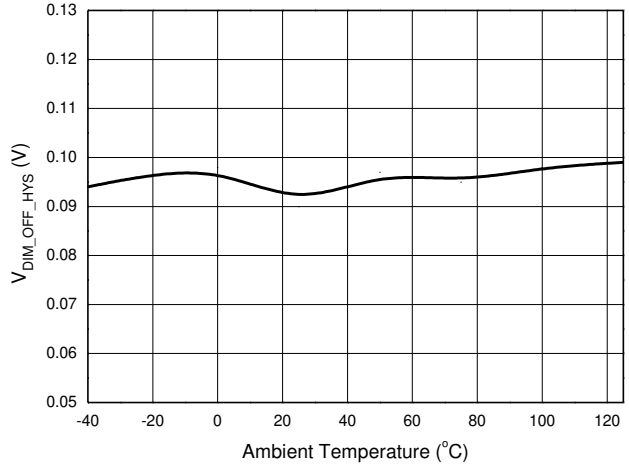

D_{VDIM_2.25V} vs. Ambient Temperature

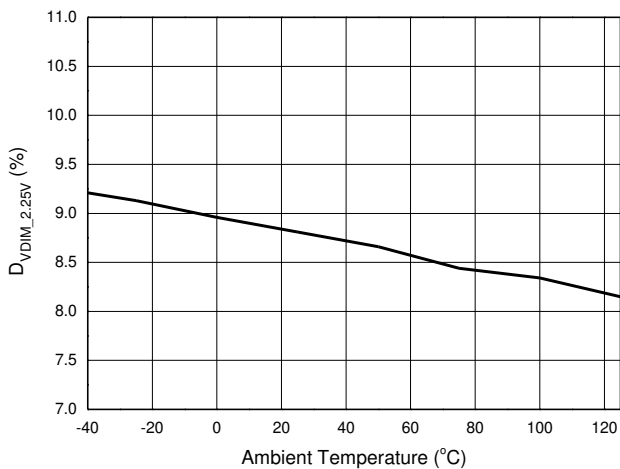

D_{VDIM_5.8V} vs. Ambient Temperature

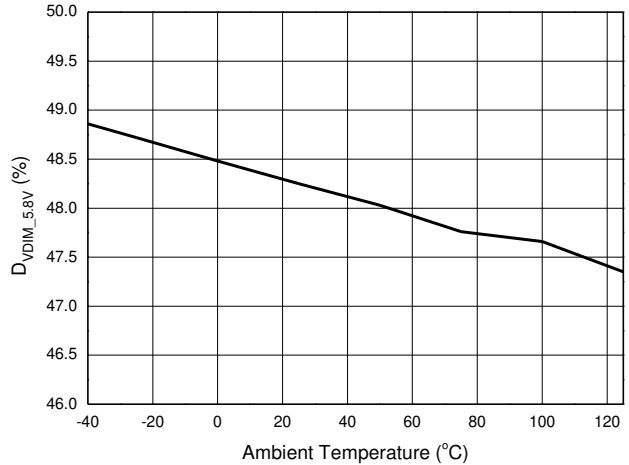

Performance Characteristics (continued)

D_{VDIM_9.35V} vs. Ambient Temperature

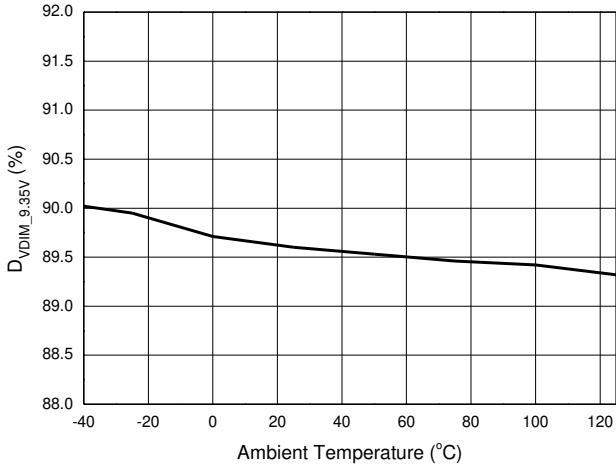

D_{OUT_4%} vs. Ambient Temperature

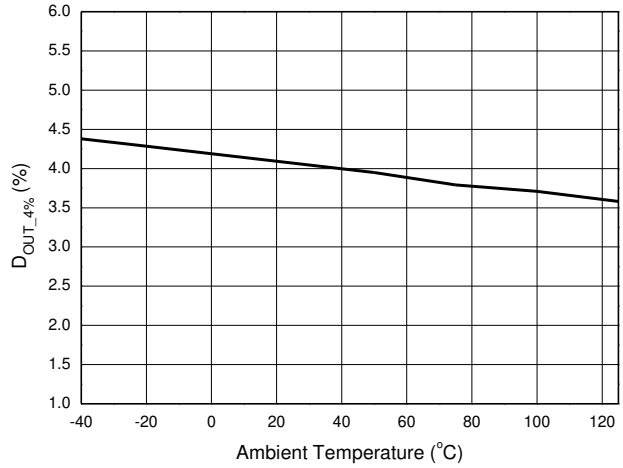

D_{OUT_6%} vs. Ambient Temperature

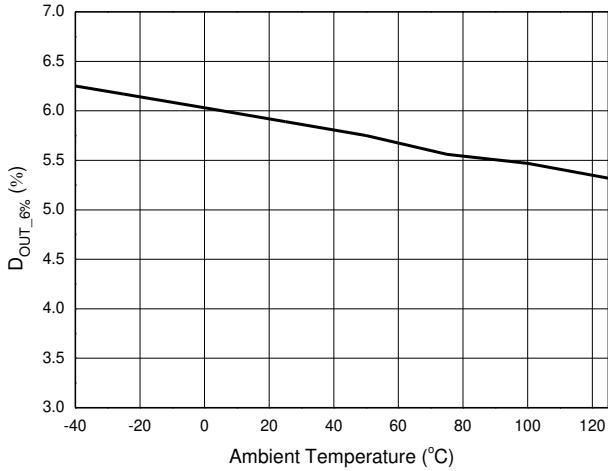

D_{OUT_8%} vs. Ambient Temperature

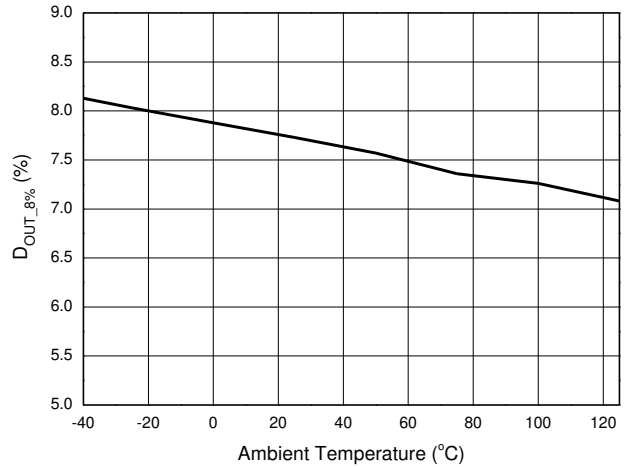

V_{OUT_LOW} Voltage vs. Ambient Temperature

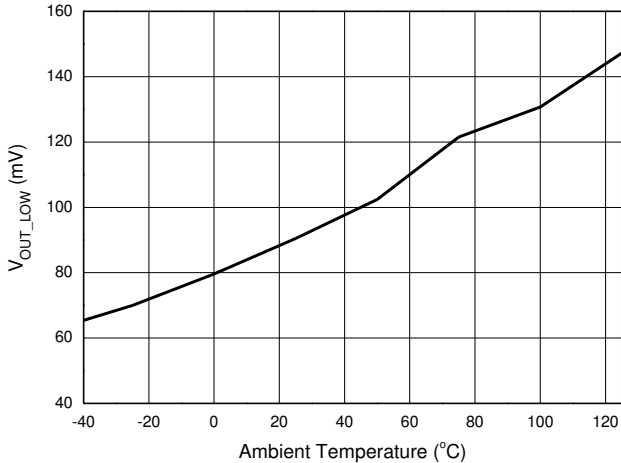

f_{OUT} vs. Ambient Temperature

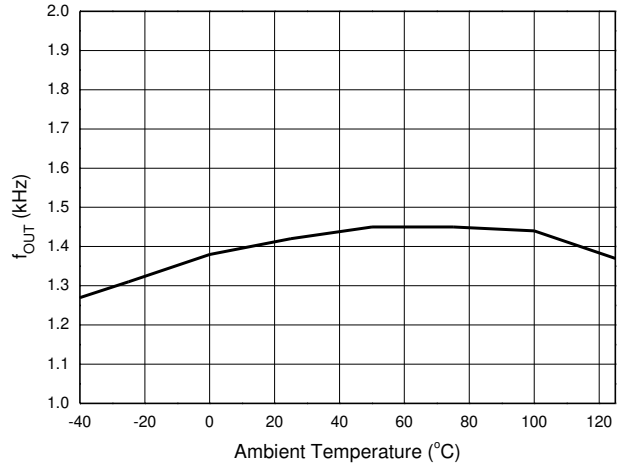

Functional Description and Application Information

Operating Overview

The AL8116 is an excellent 3-in-1 dimming signal interface controller for LED commercial lighting applications. It integrates many functions to reduce the external components' count and the PCB board size.

The AL8116 can convert the three different inputs of dimmer type including 0 to 10V DC linear dimming, 0 to 100% duty cycle PWM (pulse width modulation) signal and a simple resistive potentiometer to an output PWM signal. The output of AL8116 is an open-drain configuration that can pull down any source directly to control power supply dimming. The DIM pin of AL8116 provides an adjustable bias current, thus it can be compatible with both active and passive 0 to 10V dimmers, meanwhile potentiometers. It also can be used in an isolation dimming control via an opto-coupler with combination use of Diodes Incorporated's primary side dimmable LED drivers AL1665 and AL1666.

Startup and Under Voltage Lockout (UVLO)

A UVLO comparator is embedded to detect the voltage on the VCC pin to ensure the supply voltage enough to power on the AL8116. The turn-on and turn-off threshold voltages are fixed at V_{CC_ON} (7V) and V_{CC_OFF} (6V) respectively. When the voltage of VCC pin is above V_{CC_OFF} (6V), the AL8116 will generate PWM output based on the input DC voltage, PWM signal or potentiometer.

Bias Current of DIM Pin

The ISET pin of AL8116 is used to set the bias current of DIM pin by a resistor (R_{ISET}), which is connected between ISET pin and GND. For the typical application, the output bias current of DIM pin is 100μA when R_{ISET} is 100kΩ. The relationship between resistor and output bias current is:

$$I_{DIM} = \frac{2.5V}{R_{ISET}} \times K_{DIM}$$

Where, K_{DIM} is a coefficient of current ratio of I_{DIM} to I_{SET}. The resistance range of R_{ISET} is recommended from 33kΩ to 330kΩ and the range of bias current is 30μA to 300μA correspondingly.

Minimum Output Duty Cycle

When the input of DIM pin is DC potential, the CLAMP pin of AL8116 can set minimum output duty cycle by a resistor (R_{CLAMP}) on CLAMP pin which is connected to GND. There are four modes for users to select. Please refer to the below Table 1. The relationship between the R_{CLAMP} resistor and the voltage on CLAMP pin is below formula.

$$V_{CLAMP} = I_{CLAMP} \times R_{CLAMP} = \frac{2.5V}{R_{ISET}} \times K_{CLAMP} \times R_{CLAMP}$$

Where, K_{CLAMP} is a coefficient of current ratio of I_{CLAMP} per I_{SET}.

Table 1. Minimum Output Duty Cycles Clamping Selection

V _{CLAMP} (V)	Suggestion R _{CLAMP} (Ω) When R _{ISET} = 100kΩ	Minimum Output Duty Clamping
<0.5	0 (Short)	8%
1 to 2	150k	6%
2.6 to 3.6	300k	4%
>4.2	>510k (Open)	No Clamping

The minimum output duty cycle is clamped when V_{CLAMP} < 4.2V; When the DIM Pin voltage (V_{DIM}) decreases from 10.2V to V_{DIM_OFF} = 1.3V, the output duty cycle decreases from 100% to the minimum output clamping duty, which is set in Table 1. When the V_{DIM} signal increases from V_{DIM_ON} = 1.4V to 10.2V, the output duty cycle increases from the minimum output clamping duty to 100% accordingly. There's 100mV hysteresis for V_{DIM_OFF} and V_{DIM_ON} voltage. The dimming curve is shown in Figure 3a.

When V_{CLAMP} ≥ 4.2V, the minimum output duty cycle will not be clamped and it can reach 0%. Thus, the output duty cycle can be adjusted from 0% to 100%, shown in Figure 3b.

Ordering Information (Note 9)

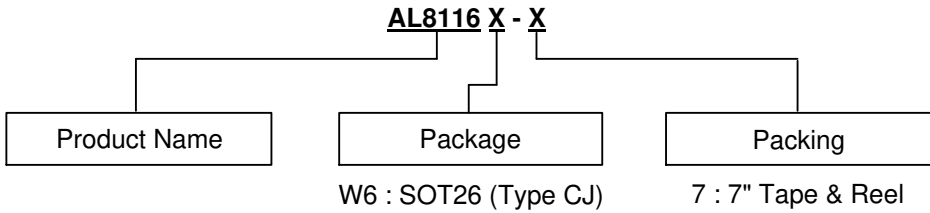

Part Number	Package Code	Package	7" Tape and Reel	
			Quantity	Part Number Suffix
AL8116W6-7	W6	SOT26 (Type CJ)	3000/Tape & Reel	-7

Note: 9. For packaging details, go to our website at <https://www.diodes.com/design/support/packaging/diodes-packaging/>.

Marking Information

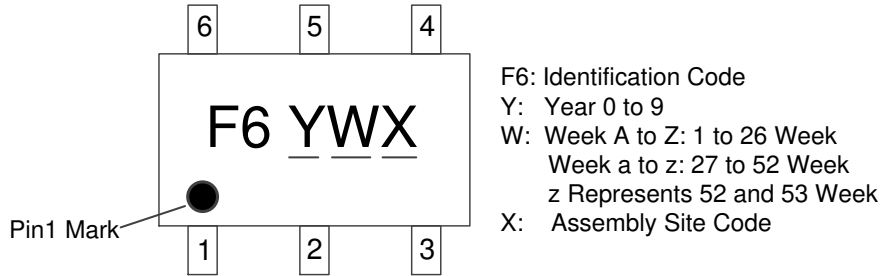

Package Outline Dimensions

Please see <http://www.diodes.com/package-outlines.html> for the latest version.

SOT26 (Type CJ)

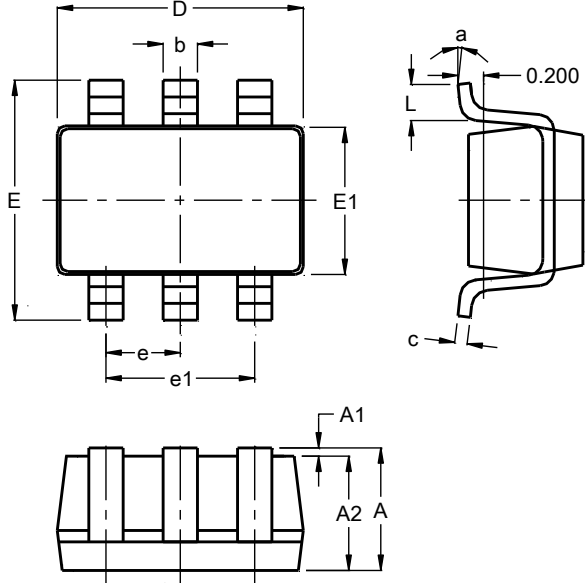

SOT26 (Type CJ)			
Dim	Min	Max	Typ
A	1.050	1.250	--
A1	0.00	0.10	--
A2	1.050	1.150	--
b	0.300	0.500	--
c	0.100	0.200	--
D	2.820	3.020	--
E	2.650	2.950	--
E1	1.500	1.700	--
e	0.950BSC		
e1	1.800	2.000	--
L	0.300	0.600	--
a	0°	8°	--
All Dimensions in mm			

Suggested Pad Layout

Please see <http://www.diodes.com/package-outlines.html> for the latest version.

SOT26 (Type CJ)

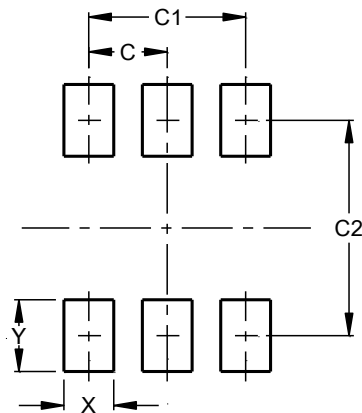

Dimensions	Value (in mm)
C	0.95
C1	1.90
C2	2.40
X	0.60
Y	1.00

Mechanical Data

- Moisture Sensitivity: Level 3 per JESD22-A113
- Terminals: Finish - Matte Tin Plated Leads, Solderable per M2003 JESD22-B102⁽³⁾
- Weight: 0.016 grams (Approximate)

IMPORTANT NOTICE

DIODES INCORPORATED MAKES NO WARRANTY OF ANY KIND, EXPRESS OR IMPLIED, WITH REGARDS TO THIS DOCUMENT, INCLUDING, BUT NOT LIMITED TO, THE IMPLIED WARRANTIES OF MERCHANTABILITY AND FITNESS FOR A PARTICULAR PURPOSE (AND THEIR EQUIVALENTS UNDER THE LAWS OF ANY JURISDICTION).

Diodes Incorporated and its subsidiaries reserve the right to make modifications, enhancements, improvements, corrections or other changes without further notice to this document and any product described herein. Diodes Incorporated does not assume any liability arising out of the application or use of this document or any product described herein; neither does Diodes Incorporated convey any license under its patent or trademark rights, nor the rights of others. Any Customer or user of this document or products described herein in such applications shall assume all risks of such use and will agree to hold Diodes Incorporated and all the companies whose products are represented on Diodes Incorporated website, harmless against all damages.

Diodes Incorporated does not warrant or accept any liability whatsoever in respect of any products purchased through unauthorized sales channel. Should Customers purchase or use Diodes Incorporated products for any unintended or unauthorized application, Customers shall indemnify and hold Diodes Incorporated and its representatives harmless against all claims, damages, expenses, and attorney fees arising out of, directly or indirectly, any claim of personal injury or death associated with such unintended or unauthorized application.

Products described herein may be covered by one or more United States, international or foreign patents pending. Product names and markings noted herein may also be covered by one or more United States, international or foreign trademarks.

This document is written in English but may be translated into multiple languages for reference. Only the English version of this document is the final and determinative format released by Diodes Incorporated.

LIFE SUPPORT

Diodes Incorporated products are specifically not authorized for use as critical components in life support devices or systems without the express written approval of the Chief Executive Officer of Diodes Incorporated. As used herein:

A. Life support devices or systems are devices or systems which:

1. are intended to implant into the body, or
2. support or sustain life and whose failure to perform when properly used in accordance with instructions for use provided in the labeling can be reasonably expected to result in significant injury to the user.

B. A critical component is any component in a life support device or system whose failure to perform can be reasonably expected to cause the failure of the life support device or to affect its safety or effectiveness.

Customers represent that they have all necessary expertise in the safety and regulatory ramifications of their life support devices or systems, and acknowledge and agree that they are solely responsible for all legal, regulatory and safety-related requirements concerning their products and any use of Diodes Incorporated products in such safety-critical, life support devices or systems, notwithstanding any devices- or systems-related information or support that may be provided by Diodes Incorporated. Further, Customers must fully indemnify Diodes Incorporated and its representatives against any damages arising out of the use of Diodes Incorporated products in such safety-critical, life support devices or systems.

Copyright © 2020, Diodes Incorporated

www.diodes.com