

1. Product profile

1.1 General description

60 W LDMOS power module with excellent gain flatness for Industrial, Scientific and Medical (ISM) applications at frequencies from 2400 MHz to 2500 MHz. The module is designed as a dual stage high gain medium power amplifier for CW and pulsed applications.

Table 1. Test information

Typical RF performance at $V_{DS} = 32\text{ V}$; $T_{mb} = 25\text{ °C}$; $I_{Dq1(A)} = I_{Dq1(B)} = 25\text{ mA}$;
 $I_{Dq2(A)} = I_{Dq2(B)} = 50\text{ mA}$.

Test signal	f (MHz)	V _{DS} (V)	P _L (W)	G _p (dB)	η _D (%)
CW	2450	32	60	26	41
CW pulsed [1]	2450	32	60	26.5	42

[1] Pulse width is 300 μs; duty cycle is 50 %.

1.2 Features and benefits

- Flat gain
- Small size: 72 × 34 mm
- Input/output 50 Ω matched
- Balanced configuration
- Designed for broadband operation (2400 MHz to 2500 MHz)
- Built-in temperature sensor
- Built-in temperature compensation in biasing networks
- 100 % RF testing in production
- For RoHS compliance see the product details on the Ampleon website

1.3 Applications

- RF power amplifiers for CW applications in the 2400 MHz to 2500 MHz frequency range such as industrial heating and drying, scientific, medical, plasma lighting and solid state cooking

2. Pinning information

2.1 Pinning

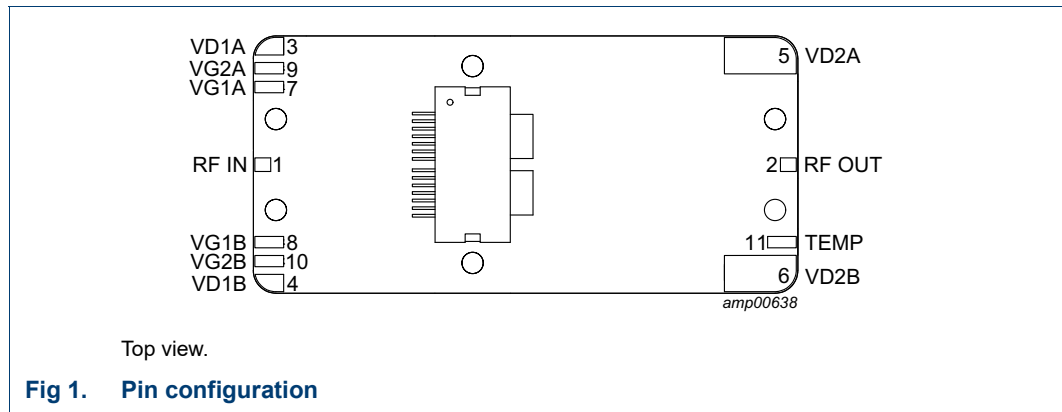

2.2 Pin description

Table 2. Pin description

Symbol	Pin	Description
RF IN	1	RF input
RF OUT	2	RF output
VD1A	3	drain-source voltage driver, section A
VD1B	4	drain-source voltage driver, section B
VD2A	5	drain-source voltage final, section A
VD2B	6	drain-source voltage final, section B
VG1A	7	gate-source voltage driver, section A
VG1B	8	gate-source voltage driver, section B
VG2A	9	gate-source voltage final, section A
VG2B	10	gate-source voltage final, section B
TEMP	11	temperature sensor

3. Ordering information

Table 3. Ordering information

Type number	Package		Version
	Name	Description	
BPC2425M7X60	-	pallet LDMOS; 6 mounting holes; 11 terminations	-

4. Block diagram

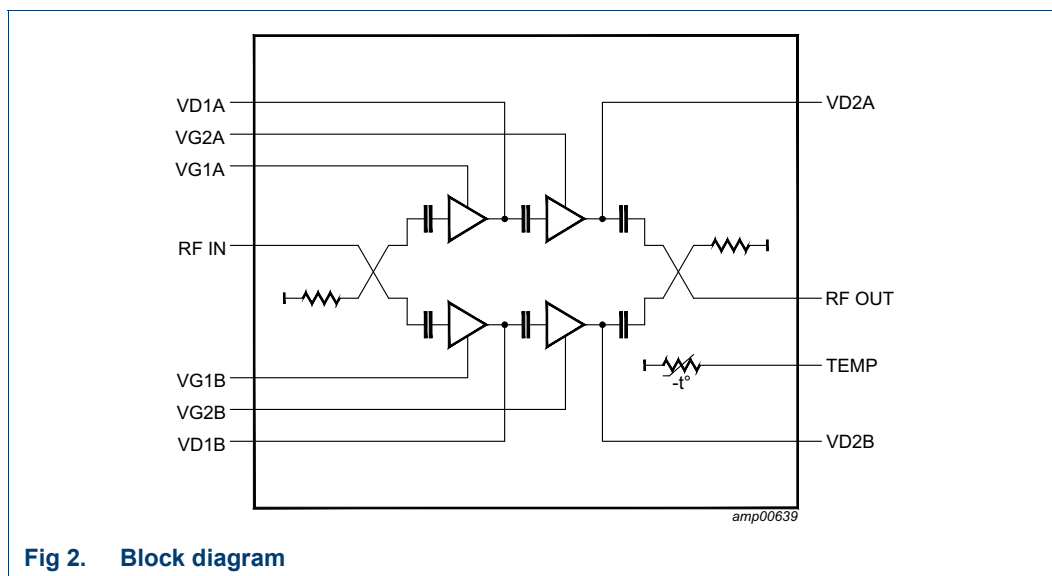

Fig 2. Block diagram

5. Limiting values

Table 4. Limiting values

In accordance with the Absolute Maximum Rating System (IEC 60134).

Symbol	Parameter	Conditions	Min	Max	Unit
V_{DS}	drain-source voltage	non operating	0	65	V
V_{GS}	gate-source voltage	non operating	-6	+13	V
T_{stg}	storage temperature		-65	+85	°C
T_{mb}	mounting base temperature		0	85	°C

6. Characteristics

Table 5. DC characteristics

Symbol	Parameter	Conditions	Min	Typ	Max	Unit
$V_{(BR)DSS}$	drain-source breakdown voltage	$V_{GS} = 0\text{ V}; I_D = 2.7\text{ mA}$	65	-	-	V
$V_{GS(th)}$	gate-source threshold voltage	driver (VG1A, VG1B); $V_{DS} = 32\text{ V}; I_D = 25\text{ mA}$	-	1.95	-	V
		final (VG2A, VG2B); $V_{DS} = 32\text{ V}; I_D = 50\text{ mA}$	-	1.85	-	V
I_{DSS}	drain leakage current	$V_{GS} = 0\text{ V}; V_{DS} = 32\text{ V}$	-	-	4.20	μA
R_{GS}	gate-source resistance		300	1500	5000	Ω
C_{iss}	input capacitance	VG1A, VG2B pins	-	0.01	-	μF
		VD1A, VD2B pins	-	0.47	-	μF

Table 6. RF Characteristics

Test signal: CW; RF performance at $T_{mb} = 25\text{ °C}$; $V_{DS} = 32\text{ V}$; $I_{Dq1(A)} = I_{Dq1(B)} = 25\text{ mA}$; $I_{Dq2(A)} = I_{Dq2(B)} = 50\text{ mA}$; unless otherwise specified; in a class-AB production test circuit.

Symbol	Parameter	Conditions	Min	Typ	Max	Unit
G_p	power gain	$P_L = 60\text{ W}$; $f = 2400\text{ MHz}$ to $f = 2500\text{ MHz}$	25	26	-	dB
$P_{L(1dB)}$	output power at 1 dB gain compression	$f = 2400\text{ MHz}$ to $f = 2500\text{ MHz}$	-	80	-	W
$P_{L(3dB)}$	output power at 3 dB gain compression	$f = 2400\text{ MHz}$ to $f = 2500\text{ MHz}$	-	90	-	W
f	frequency	$P_L = 60\text{ W}$	2400	-	2500	MHz
G_{flat}	gain flatness	$P_L = 60\text{ W}$; $f = 2400\text{ MHz}$ to $f = 2500\text{ MHz}$	-	0.5	-	dB
RL_{in}	input return loss	$P_L = 60\text{ W}$; $f = 2400\text{ MHz}$ to $f = 2500\text{ MHz}$	-	-25	-12	dB
η_D	drain efficiency	$P_L = 60\text{ W}$; $f = 2450\text{ MHz}$	38.5	41	-	%
$\alpha_{sup(H)}$	harmonic suppression	$P_L = 300\text{ W}$; $f = 2450\text{ MHz}$	-	30	-	dBc

6.1 Ruggedness in class-AB operation

The BPC2425M7X60 is capable of withstanding a load mismatch corresponding to $VSWR = 10 : 1$ through all phases with a time rate of 15 ms/degree under the following conditions: $V_{DS} = 32\text{ V}$; $I_{Dq1(A)} = I_{Dq1(B)} = 25\text{ mA}$; $I_{Dq2(A)} = I_{Dq2(B)} = 50\text{ mA}$; $P_L = 60\text{ W}$ (CW); $f = 2450\text{ MHz}$; $T_{mb} = 25\text{ °C}$.

7. Test information

7.1 Graphical data

7.1.1 CW

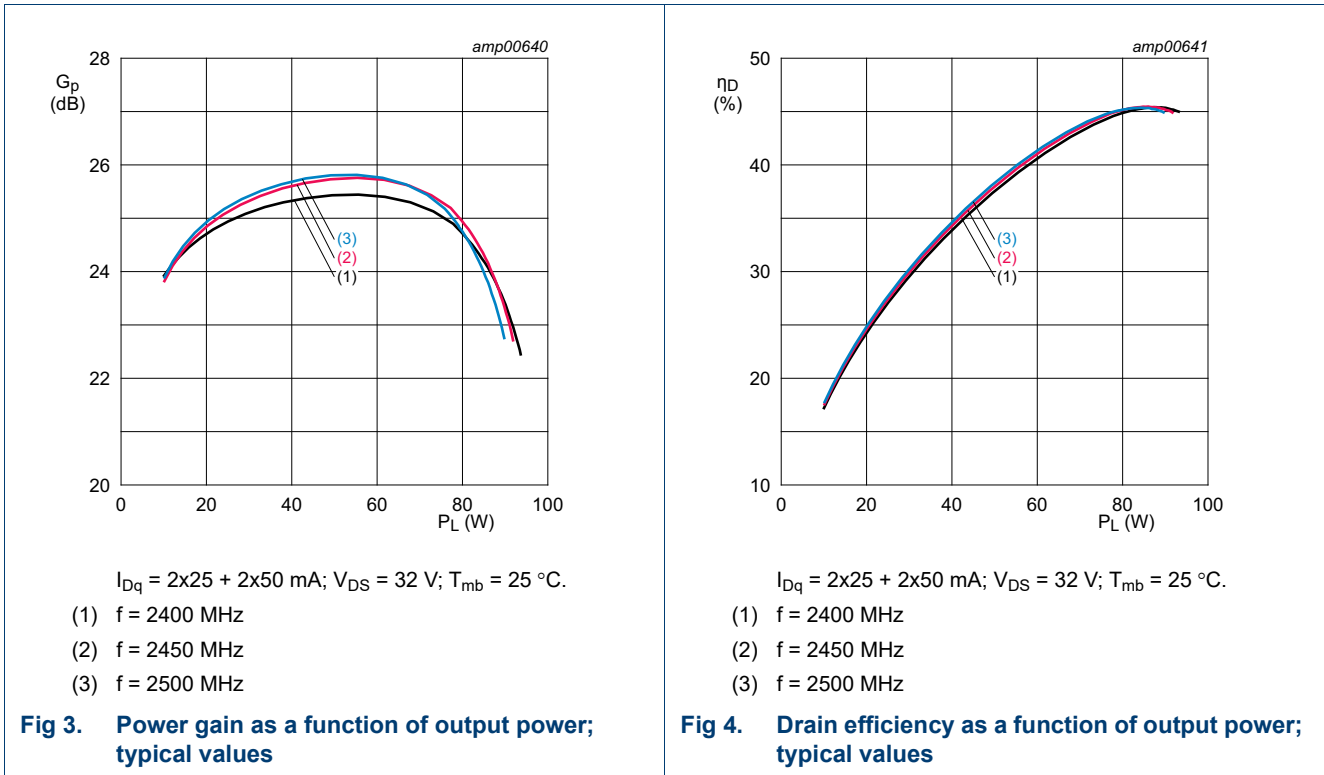

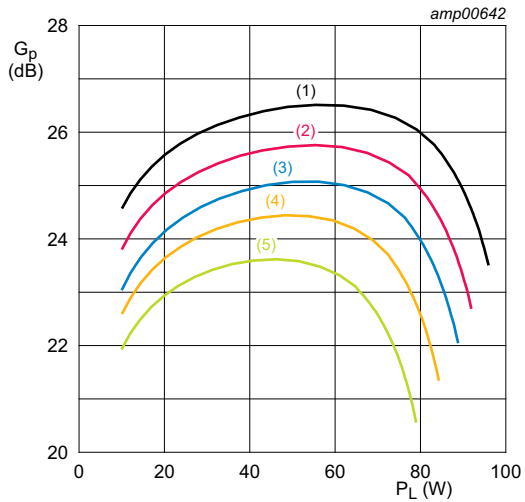

$I_{Dq} = 2 \times 25 + 2 \times 50$ mA; $V_{DS} = 32$ V; $f = 2450$ MHz.
 (1) $T_{mb} = 5$ °C
 (2) $T_{mb} = 25$ °C
 (3) $T_{mb} = 40$ °C
 (4) $T_{mb} = 60$ °C
 (5) $T_{mb} = 85$ °C

Fig 5. Power gain as a function of output power; typical values

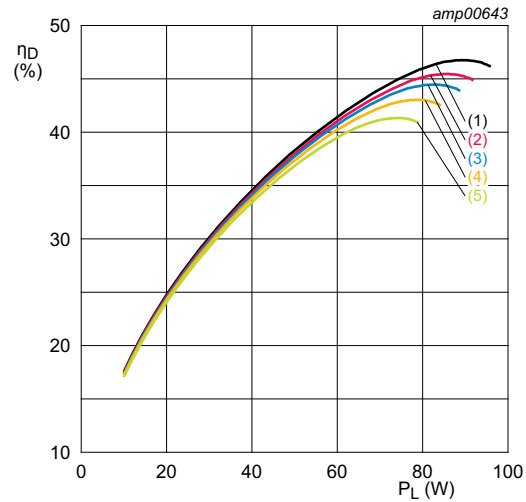

$I_{Dq} = 2 \times 25 + 2 \times 50$ mA; $V_{DS} = 32$ V; $f = 2450$ MHz.
 (1) $T_{mb} = 5$ °C
 (2) $T_{mb} = 25$ °C
 (3) $T_{mb} = 40$ °C
 (4) $T_{mb} = 60$ °C
 (5) $T_{mb} = 85$ °C

Fig 6. Drain efficiency as a function of output power; typical values

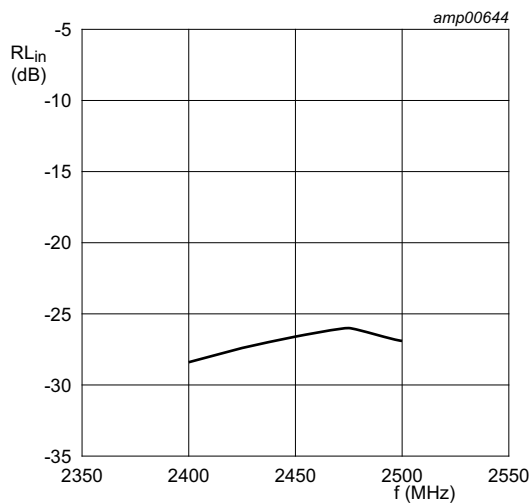

$I_{Dq} = 2 \times 25 + 2 \times 50$ mA; $V_{DS} = 32$ V; $P_L = 60$ W.

Fig 7. Input return loss as a function of frequency; typical values

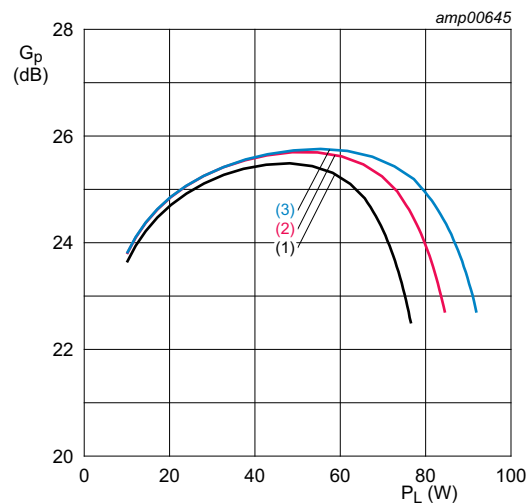

$I_{Dq} = 2 \times 25 + 2 \times 50$ mA; $T_{mb} = 25$ °C; $f = 2450$ MHz.
 (1) $V_{DS} = 28$ V
 (2) $V_{DS} = 30$ V
 (3) $V_{DS} = 32$ V

Fig 8. Power gain as a function of output power; typical values

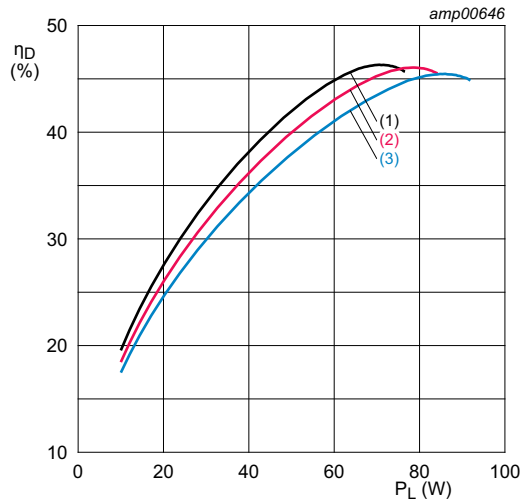

$I_{Dq} = 2 \times 25 + 2 \times 50$ mA; $T_{mb} = 25$ °C; $f = 2450$ MHz.

- (1) $V_{DS} = 28$ V
- (2) $V_{DS} = 30$ V
- (3) $V_{DS} = 32$ V

Fig 9. Drain efficiency as a function of output power; typical values

7.1.2 CW pulsed

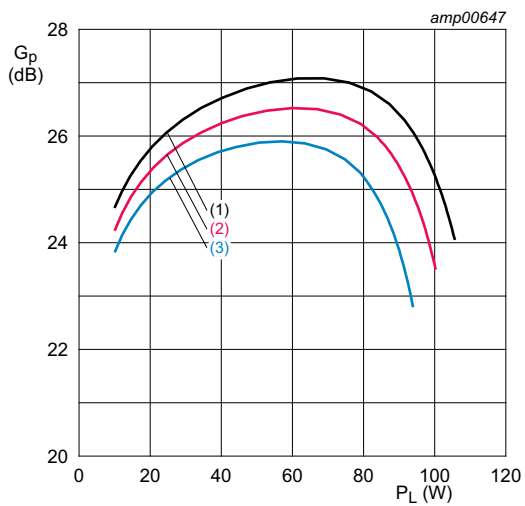

$I_{Dq} = 2 \times 25 + 2 \times 50$ mA; $T_{mb} = 25$ °C; $f = 2450$ MHz; $V_{DS} = 32$ V.

- (1) $t_p = 300$ μs; $\delta = 10$ %
- (2) $t_p = 300$ μs; $\delta = 50$ %
- (3) $t_p = 300$ μs; $\delta = 90$ %

Fig 10. Power gain as a function of output power; typical values

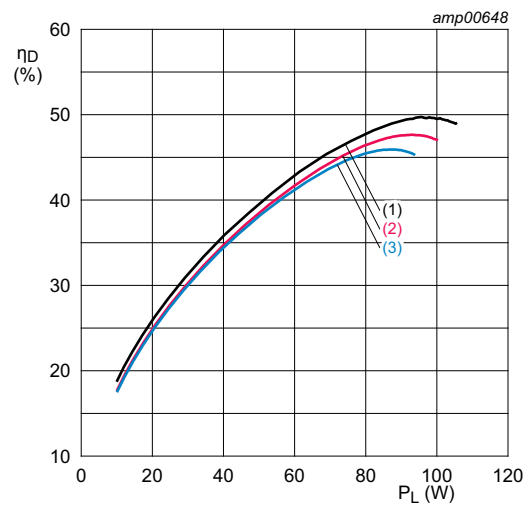

$I_{Dq} = 2 \times 25 + 2 \times 50$ mA; $T_{mb} = 25$ °C; $f = 2450$ MHz; $V_{DS} = 32$ V.

- (1) $t_p = 300$ μs; $\delta = 10$ %
- (2) $t_p = 300$ μs; $\delta = 50$ %
- (3) $t_p = 300$ μs; $\delta = 90$ %

Fig 11. Drain efficiency as a function of output power; typical values

8. Package outline

Pallet; 6 mounting holes; 11 terminations

BPC2425M7X60

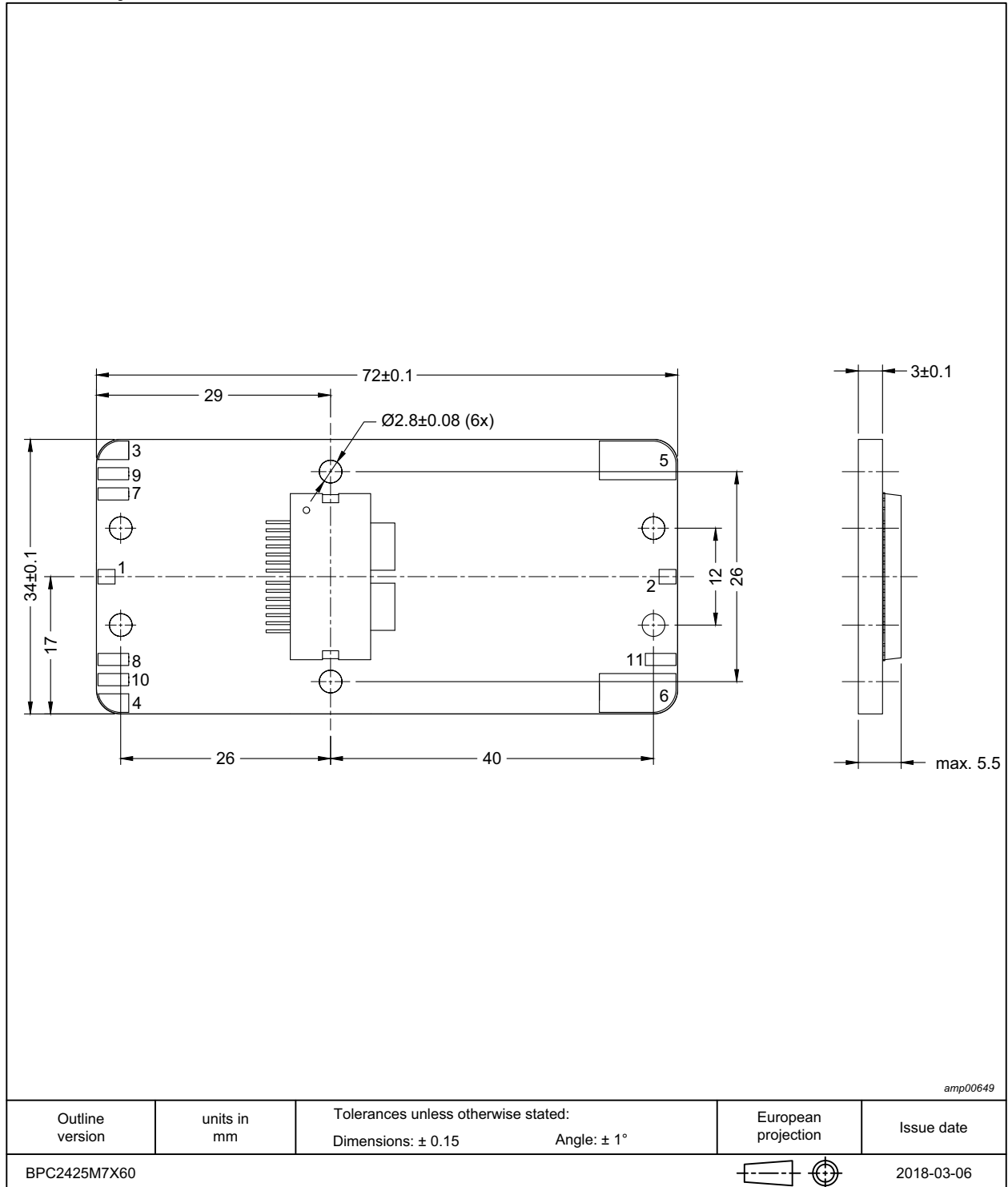

Fig 12. Package outline

9. Handling information

CAUTION



This device is sensitive to ElectroStatic Discharge (ESD). Observe precautions for handling electrostatic sensitive devices.

Such precautions are described in the *ANSI/ESD S20.20*, *IEC/ST 61340-5*, *JESD625-A* or equivalent standards.

Table 7. ESD sensitivity

ESD model	Class
Charged Device Model (CDM); According to ANSI/ESDA/JEDEC standard JS-002	C1 [1]
Human Body Model (HBM); According to ANSI/ESDA/JEDEC standard JS-001	1C [2]

[1] CDM classification C1 is granted to any part that passes after exposure to an ESD pulse of 250 V, but fails after exposure to an ESD pulse of 500 V.

[2] HBM classification 1C is granted to any part that passes after exposure to an ESD pulse of 1000 V, but fails after exposure to an ESD pulse of 2000 V.

10. Abbreviations

Table 8. Abbreviations

Acronym	Description
CW	Continuous Wave
LDMOS	Laterally Diffused Metal-Oxide Semiconductor
MTF	Median Time to Failure
RoHS	Restriction of Hazardous Substances
VSWR	Voltage Standing Wave Ratio

11. Revision history

Table 9. Revision history

Document ID	Release date	Data sheet status	Change notice	Supersedes
BPC2425M7X60 v.1	20180329	Product data sheet	-	-

12. Legal information

12.1 Data sheet status

Document status ^{[1][2]}	Product status ^[3]	Definition
Objective [short] data sheet	Development	This document contains data from the objective specification for product development.
Preliminary [short] data sheet	Qualification	This document contains data from the preliminary specification.
Product [short] data sheet	Production	This document contains the product specification.

[1] Please consult the most recently issued document before initiating or completing a design.

[2] The term 'short data sheet' is explained in section "Definitions".

[3] The product status of device(s) described in this document may have changed since this document was published and may differ in case of multiple devices. The latest product status information is available on the Internet at URL <http://www.ampleon.com>.

12.2 Definitions

Draft — The document is a draft version only. The content is still under internal review and subject to formal approval, which may result in modifications or additions. Ampleon does not give any representations or warranties as to the accuracy or completeness of information included herein and shall have no liability for the consequences of use of such information.

Short data sheet — A short data sheet is an extract from a full data sheet with the same product type number(s) and title. A short data sheet is intended for quick reference only and should not be relied upon to contain detailed and full information. For detailed and full information see the relevant full data sheet, which is available on request via the local Ampleon sales office. In case of any inconsistency or conflict with the short data sheet, the full data sheet shall prevail.

Product specification — The information and data provided in a Product data sheet shall define the specification of the product as agreed between Ampleon and its customer, unless Ampleon and customer have explicitly agreed otherwise in writing. In no event however, shall an agreement be valid in which the Ampleon product is deemed to offer functions and qualities beyond those described in the Product data sheet.

12.3 Disclaimers

Limited warranty and liability — Information in this document is believed to be accurate and reliable. However, Ampleon does not give any representations or warranties, expressed or implied, as to the accuracy or completeness of such information and shall have no liability for the consequences of use of such information. Ampleon takes no responsibility for the content in this document if provided by an information source outside of Ampleon.

In no event shall Ampleon be liable for any indirect, incidental, punitive, special or consequential damages (including - without limitation - lost profits, lost savings, business interruption, costs related to the removal or replacement of any products or rework charges) whether or not such damages are based on tort (including negligence), warranty, breach of contract or any other legal theory.

Notwithstanding any damages that customer might incur for any reason whatsoever, Ampleon's aggregate and cumulative liability towards customer for the products described herein shall be limited in accordance with the *Terms and conditions of commercial sale* of Ampleon.

Right to make changes — Ampleon reserves the right to make changes to information published in this document, including without limitation specifications and product descriptions, at any time and without notice. This document supersedes and replaces all information supplied prior to the publication hereof.

Suitability for use — Ampleon products are not designed, authorized or warranted to be suitable for use in life support, life-critical or safety-critical systems or equipment, nor in applications where failure or malfunction of an

Ampleon product can reasonably be expected to result in personal injury, death or severe property or environmental damage. Ampleon and its suppliers accept no liability for inclusion and/or use of Ampleon products in such equipment or applications and therefore such inclusion and/or use is at the customer's own risk.

Applications — Applications that are described herein for any of these products are for illustrative purposes only. Ampleon makes no representation or warranty that such applications will be suitable for the specified use without further testing or modification.

Customers are responsible for the design and operation of their applications and products using Ampleon products, and Ampleon accepts no liability for any assistance with applications or customer product design. It is customer's sole responsibility to determine whether the Ampleon product is suitable and fit for the customer's applications and products planned, as well as for the planned application and use of customer's third party customer(s). Customers should provide appropriate design and operating safeguards to minimize the risks associated with their applications and products.

Ampleon does not accept any liability related to any default, damage, costs or problem which is based on any weakness or default in the customer's applications or products, or the application or use by customer's third party customer(s). Customer is responsible for doing all necessary testing for the customer's applications and products using Ampleon products in order to avoid a default of the applications and the products or of the application or use by customer's third party customer(s). Ampleon does not accept any liability in this respect.

Limiting values — Stress above one or more limiting values (as defined in the Absolute Maximum Ratings System of IEC 60134) will cause permanent damage to the device. Limiting values are stress ratings only and (proper) operation of the device at these or any other conditions above those given in the Recommended operating conditions section (if present) or the Characteristics sections of this document is not warranted. Constant or repeated exposure to limiting values will permanently and irreversibly affect the quality and reliability of the device.

Terms and conditions of commercial sale — Ampleon products are sold subject to the general terms and conditions of commercial sale, as published at <http://www.ampleon.com/terms>, unless otherwise agreed in a valid written individual agreement. In case an individual agreement is concluded only the terms and conditions of the respective agreement shall apply. Ampleon hereby expressly objects to applying the customer's general terms and conditions with regard to the purchase of Ampleon products by customer.

No offer to sell or license — Nothing in this document may be interpreted or construed as an offer to sell products that is open for acceptance or the grant, conveyance or implication of any license under any copyrights, patents or other industrial or intellectual property rights.

Export control — This document as well as the item(s) described herein may be subject to export control regulations. Export might require a prior authorization from competent authorities.

Non-automotive qualified products — Unless this data sheet expressly states that this specific Ampleon product is automotive qualified, the product is not suitable for automotive use. It is neither qualified nor tested in accordance with automotive testing or application requirements. Ampleon accepts no liability for inclusion and/or use of non-automotive qualified products in automotive equipment or applications.

In the event that customer uses the product for design-in and use in automotive applications to automotive specifications and standards, customer (a) shall use the product without Ampleon's warranty of the product for such automotive applications, use and specifications, and (b) whenever customer uses the product for automotive applications beyond Ampleon's specifications such use shall be solely at customer's own risk, and (c) customer fully indemnifies Ampleon for any liability, damages or failed product claims resulting from customer design and use of the product for automotive applications beyond Ampleon's standard warranty and Ampleon's product specifications.

Translations — A non-English (translated) version of a document is for reference only. The English version shall prevail in case of any discrepancy between the translated and English versions.

12.4 Trademarks

Notice: All referenced brands, product names, service names and trademarks are the property of their respective owners.

Any reference or use of any 'NXP' trademark in this document or in or on the surface of Ampleon products does not result in any claim, liability or entitlement vis-à-vis the owner of this trademark. Ampleon is no longer part of the NXP group of companies and any reference to or use of the 'NXP' trademarks will be replaced by reference to or use of Ampleon's own trademarks.

13. Contact information

For more information, please visit: <http://www.ampleon.com>

For sales office addresses, please visit: <http://www.ampleon.com/sales>

14. Contents

1 Product profile 1

1.1 General description 1

1.2 Features and benefits 1

1.3 Applications 1

2 Pinning information 2

2.1 Pinning 2

2.2 Pin description 2

3 Ordering information 2

4 Block diagram 3

5 Limiting values 3

6 Characteristics 3

6.1 Ruggedness in class-AB operation 4

7 Test information 5

7.1 Graphical data 5

7.1.1 CW 5

7.1.2 CW pulsed 7

8 Package outline 8

9 Handling information 9

10 Abbreviations 9

11 Revision history 9

12 Legal information 10

12.1 Data sheet status 10

12.2 Definitions 10

12.3 Disclaimers 10

12.4 Trademarks 11

13 Contact information 11

14 Contents 12

Please be aware that important notices concerning this document and the product(s) described herein, have been included in section 'Legal information'.

© Ampleon Netherlands B.V. 2018. All rights reserved.

For more information, please visit: <http://www.ampleon.com>
 For sales office addresses, please visit: <http://www.ampleon.com/sales>

Date of release: 29 March 2018
 Document identifier: BPC2425M7X60