

MC14020B

14-Bit Binary Counter

The MC14020B 14-stage binary counter is constructed with MOS P-channel and N-channel enhancement mode devices in a single monolithic structure. This part is designed with an input wave shaping circuit and 14 stages of ripple-carry binary counter. The device advances the count on the negative-going edge of the clock pulse. Applications include time delay circuits, counter controls, and frequency-dividing circuits.

- Fully Static Operation
- Diode Protection on All Inputs
- Supply Voltage Range = 3.0 Vdc to 18 Vdc
- Capable of Driving Two Low-power TTL Loads or One Low-power Schottky TTL Load Over the Rated Temperature Range
- Buffered Outputs Available from stages 1 and 4 thru 14
- Common Reset Line
- Pin-for-Pin Replacement for CD4020B

MAXIMUM RATINGS (Voltages Referenced to V_{SS}) (Note NO TAG)

Symbol	Parameter	Value	Unit
V_{DD}	DC Supply Voltage Range	-0.5 to +18.0	V
V_{in}, V_{out}	Input or Output Voltage Range (DC or Transient)	-0.5 to $V_{DD} + 0.5$	V
I_{in}, I_{out}	Input or Output Current (DC or Transient) per Pin	± 10	mA
P_D	Power Dissipation, per Package (Note NO TAG)	500	mW
T_A	Ambient Temperature Range	-55 to +125	$^{\circ}C$
T_{stg}	Storage Temperature Range	-65 to +150	$^{\circ}C$
T_L	Lead Temperature (8-Second Soldering)	260	$^{\circ}C$

- Maximum Ratings are those values beyond which damage to the device may occur.
- Temperature Derating:
Plastic "P and D/DW" Packages: -7.0 mW/ $^{\circ}C$ From 65 $^{\circ}C$ To 125 $^{\circ}C$

This device contains protection circuitry to guard against damage due to high static voltages or electric fields. However, precautions must be taken to avoid applications of any voltage higher than maximum rated voltages to this high-impedance circuit. For proper operation, V_{in} and V_{out} should be constrained to the range $V_{SS} \leq (V_{in} \text{ or } V_{out}) \leq V_{DD}$.

Unused inputs must always be tied to an appropriate logic voltage level (e.g., either V_{SS} or V_{DD}). Unused outputs must be left open.



ON Semiconductor

<http://onsemi.com>

MARKING DIAGRAMS

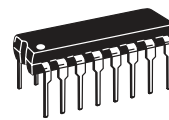

PDIP-16
P SUFFIX
CASE 648

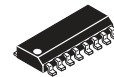
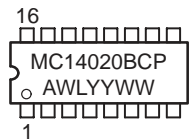

SOIC-16
D SUFFIX
CASE 751B

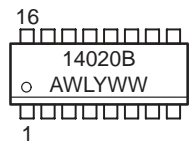

TSSOP-16
DT SUFFIX
CASE 948F

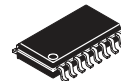
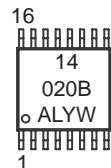

SOEIAJ-16
F SUFFIX
CASE 966

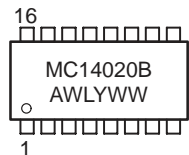

A = Assembly Location
WL or L = Wafer Lot
YY or Y = Year
WW or W = Work Week

ORDERING INFORMATION

Device	Package	Shipping
MC14020BCP	PDIP-16	2000/Box
MC14020BD	SOIC-16	48/Rail
MC14020BDR2	SOIC-16	2500/Tape & Reel
MC14020BDT	TSSOP-16	96/Rail
MC14020BF	SOEIAJ-16	See Note 1.
MC14020BFEL	SOEIAJ-16	See Note 1.



- For ordering information on the EIAJ version of the SOIC packages, please contact your local ON Semiconductor representative.

MC14020B

PIN ASSIGNMENT

Q12	1	16	V _{DD}
Q13	2	15	Q11
Q14	3	14	Q10
Q6	4	13	Q8
Q5	5	12	Q9
Q7	6	11	R
Q4	7	10	C
V _{SS}	8	9	Q1

TRUTH TABLE

Clock	Reset	Output State
	0	No Change
	0	Advance to Next State
X	1	All Outputs are Low

X = Don't Care

LOGIC DIAGRAM

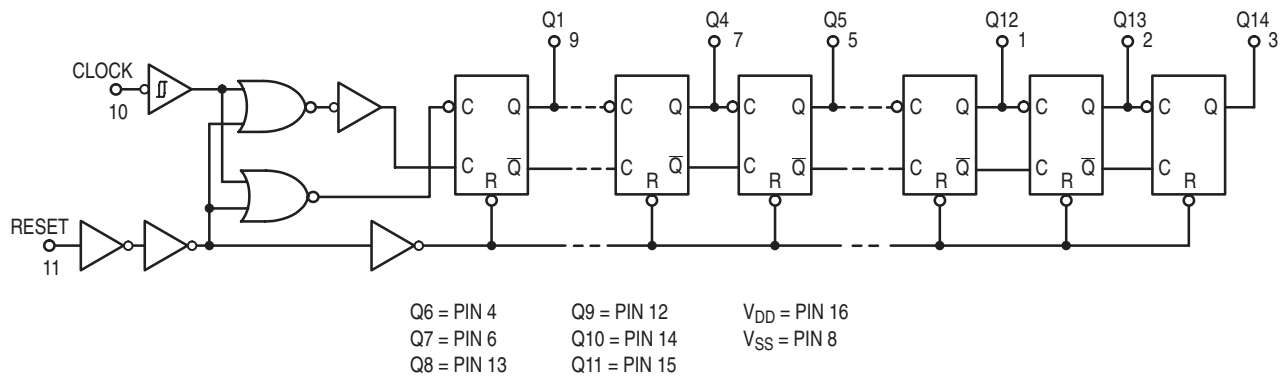

MC14020B

ELECTRICAL CHARACTERISTICS (Voltages Referenced to V_{SS})

Characteristic	Symbol	V _{DD} Vdc	- 55°C		25°C			125°C		Unit	
			Min	Max	Min	Typ (4.)	Max	Min	Max		
Output Voltage V _{in} = V _{DD} or 0 V _{in} = 0 or V _{DD}	"0" Level V _{OL}	5.0	—	0.05	—	0	0.05	—	0.05	Vdc	
		10	—	0.05	—	0	0.05	—	0.05		
		15	—	0.05	—	0	0.05	—	0.05		
	"1" Level V _{OH}	5.0	4.95	—	4.95	5.0	—	4.95	—		Vdc
		10	9.95	—	9.95	10	—	9.95	—		
		15	14.95	—	14.95	15	—	14.95	—		
Input Voltage "0" Level (V _O = 4.5 or 0.5 Vdc) (V _O = 9.0 or 1.0 Vdc) (V _O = 13.5 or 1.5 Vdc) "1" Level (V _O = 0.5 or 4.5 Vdc) (V _O = 1.0 or 9.0 Vdc) (V _O = 1.5 or 13.5 Vdc)	V _{IL}	5.0	—	1.5	—	2.25	1.5	—	1.5	Vdc	
		10	—	3.0	—	4.50	3.0	—	3.0		
		15	—	4.0	—	6.75	4.0	—	4.0		
	V _{IH}	5.0	3.5	—	3.5	2.75	—	3.5	—		Vdc
		10	7.0	—	7.0	5.50	—	7.0	—		
		15	11	—	11	8.25	—	11	—		
Output Drive Current Source (V _{OH} = 2.5 Vdc) (V _{OH} = 4.6 Vdc) (V _{OH} = 9.5 Vdc) (V _{OH} = 13.5 Vdc) Sink (V _{OL} = 0.4 Vdc) (V _{OL} = 0.5 Vdc) (V _{OL} = 1.5 Vdc)	I _{OH}	5.0	- 3.0	—	- 2.4	- 4.2	—	- 1.7	—	mAdc	
		5.0	- 0.64	—	- 0.51	- 0.88	—	- 0.36	—		
		10	- 1.6	—	- 1.3	- 2.25	—	- 0.9	—		
		15	- 4.2	—	- 3.4	- 8.8	—	- 2.4	—		
	I _{OL}	5.0	0.64	—	0.51	0.88	—	0.36	—		mAdc
		10	1.6	—	1.3	2.25	—	0.9	—		
15		4.2	—	3.4	8.8	—	2.4	—			
Input Current	I _{in}	15	—	± 0.1	—	± 0.00001	± 0.1	—	± 1.0	μAdc	
Input Capacitance (V _{in} = 0)	C _{in}	—	—	—	—	5.0	7.5	—	—	pF	
Quiescent Current (Per Package)	I _{DD}	5.0	—	5.0	—	0.005	5.0	—	150	μAdc	
		10	—	10	—	0.010	10	—	300		
		15	—	20	—	0.015	20	—	600		
Total Supply Current (5.) (6.) (Dynamic plus Quiescent, Per Package) (C _L = 50 pF on all outputs, all buffers switching)	I _T	5.0	I _T = (0.42 μA/kHz)f + I _{DD} I _T = (0.85 μA/kHz)f + I _{DD} I _T = (1.43 μA/kHz)f + I _{DD}							μAdc	

4. Data labelled "Typ" is not to be used for design purposes but is intended as an indication of the IC's potential performance.

5. The formulas given are for the typical characteristics only at 25°C.

6. To calculate total supply current at loads other than 50 pF:

$$I_T(C_L) = I_T(50 \text{ pF}) + (C_L - 50) Vfk$$

where: I_T is in μA (per package), C_L in pF, V = (V_{DD} - V_{SS}) in volts, f in kHz is input frequency, and k = 0.001.

MC14020B

SWITCHING CHARACTERISTICS (7.) ($C_L = 50 \text{ pF}$, $T_A = 25^\circ\text{C}$)

Characteristic	Symbol	V_{DD} Vdc	Min	Typ (8.)	Max	Unit
Output Rise and Fall Time t_{TLH} , $t_{THL} = (1.5 \text{ ns/pF}) C_L + 25 \text{ ns}$ t_{TLH} , $t_{THL} = (0.75 \text{ ns/pF}) C_L + 12.5 \text{ ns}$ t_{TLH} , $t_{THL} = (0.55 \text{ ns/pF}) C_L + 9.5 \text{ ns}$	t_{TLH} , t_{THL}	5.0 10 15	— — —	100 50 40	200 100 80	ns
Propagation Delay Time Clock to Q1 t_{PHL} , $t_{PLH} = (1.7 \text{ ns/pF}) C_L + 175 \text{ ns}$ t_{PHL} , $t_{PLH} = (0.66 \text{ ns/pF}) C_L + 82 \text{ ns}$ t_{PHL} , $t_{PLH} = (0.5 \text{ ns/pF}) C_L + 55 \text{ ns}$	t_{PLH} , t_{PHL}	5.0 10 15	— — —	260 115 80	520 230 160	ns
Clock to Q14 t_{PHL} , $t_{PLH} = (1.7 \text{ ns/pF}) C_L + 1735 \text{ ns}$ t_{PHL} , $t_{PLH} = (0.66 \text{ ns/pF}) C_L + 772 \text{ ns}$ t_{PHL} , $t_{PLH} = (0.5 \text{ ns/pF}) C_L + 535 \text{ ns}$		5.0 10 15	— — —	1820 805 560	3900 1725 1200	ns
Propagation Delay Time Reset to Q_n $t_{PHL} = (1.7 \text{ ns/pF}) C_L + 285 \text{ ns}$ $t_{PHL} = (0.66 \text{ ns/pF}) C_L + 122 \text{ ns}$ $t_{PHL} = (0.5 \text{ ns/pF}) C_L + 90 \text{ ns}$	t_{PHL}	5.0 10 15	— — —	370 155 115	740 310 230	ns
Clock Pulse Width	t_{WH}	5.0 10 15	500 165 125	140 55 38	— — —	ns
Clock Pulse Frequency	f_{cl}	5.0 10 15	— — —	2.0 6.0 8.0	1.0 3.0 4.0	MHz
Clock Rise and Fall Time	t_{TLH} , t_{THL}	5.0 10 15	No Limit			—
Reset Pulse Width	t_{WL}	5.0 10 15	3000 550 420	320 120 80	— — —	ns
Reset Removal Time	t_{rem}	5.0 10 15	130 50 30	65 25 15	— — —	ns

7. The formulas given are for the typical characteristics only at 25°C.

8. Data labelled "Typ" is not to be used for design purposes but is intended as an indication of the IC's potential performance.

MC14020B

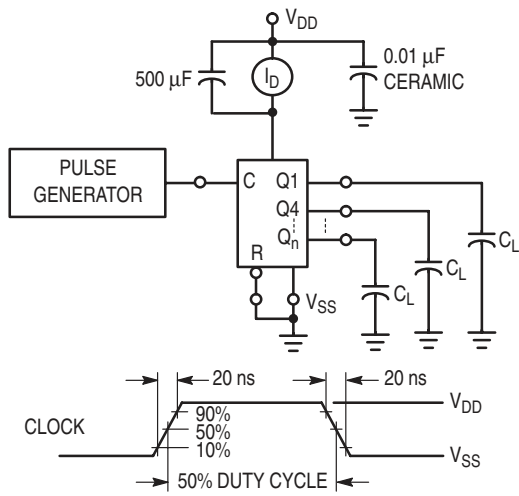

Figure 1. Power Dissipation Test Circuit and Waveform

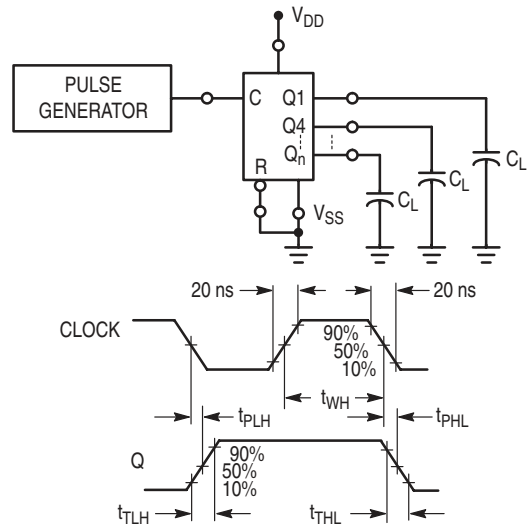

Figure 2. Switching Time Test Circuit and Waveforms

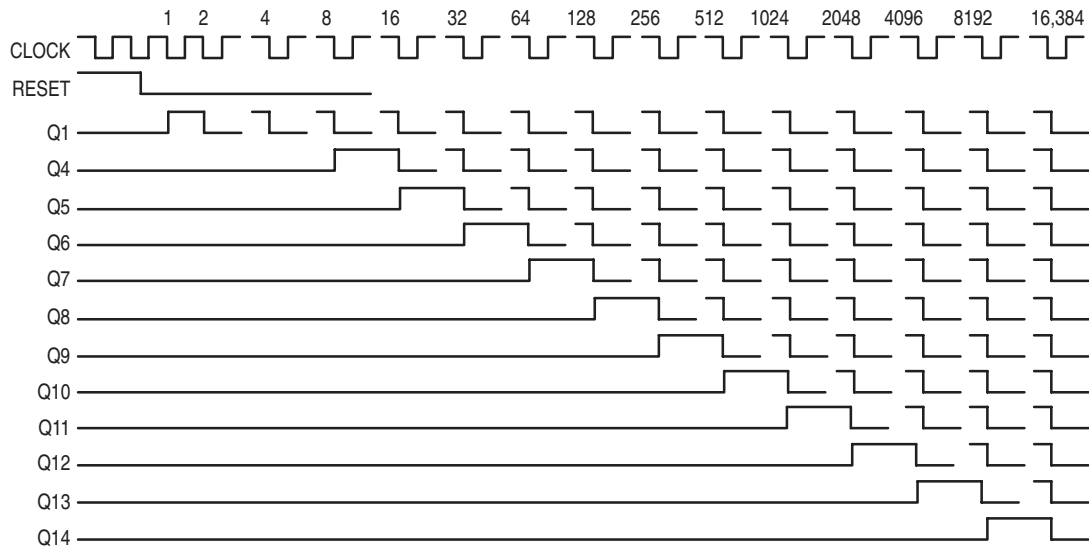
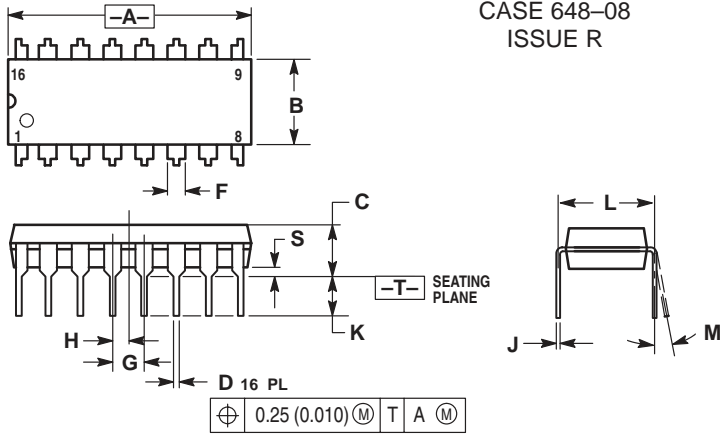

Figure 3. Timing Diagram

MC14020B

PACKAGE DIMENSIONS

PDIP-16 P SUFFIX PLASTIC DIP PACKAGE CASE 648-08 ISSUE R



NOTES:

1. DIMENSIONING AND TOLERANCING PER ANSI Y14.5M, 1982.
2. CONTROLLING DIMENSION: INCH.
3. DIMENSION L TO CENTER OF LEADS WHEN FORMED PARALLEL.
4. DIMENSION B DOES NOT INCLUDE MOLD FLASH.
5. ROUNDED CORNERS OPTIONAL.

DIM	INCHES		MILLIMETERS	
	MIN	MAX	MIN	MAX
A	0.740	0.770	18.80	19.55
B	0.250	0.270	6.35	6.85
C	0.145	0.175	3.69	4.44
D	0.015	0.021	0.39	0.53
F	0.040	0.70	1.02	1.77
G	0.100 BSC		2.54 BSC	
H	0.050 BSC		1.27 BSC	
J	0.008	0.015	0.21	0.38
K	0.110	0.130	2.80	3.30
L	0.295	0.305	7.50	7.74
M	0°	10°	0°	10°
S	0.020	0.040	0.51	1.01

SOIC-16 D SUFFIX PLASTIC SOIC PACKAGE CASE 751B-05 ISSUE J

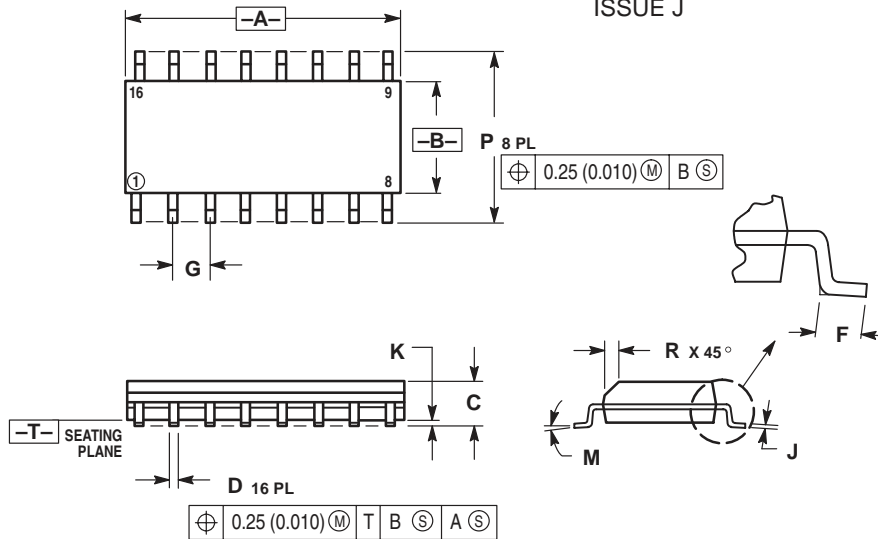

NOTES:

1. DIMENSIONING AND TOLERANCING PER ANSI Y14.5M, 1982.
2. CONTROLLING DIMENSION: MILLIMETER.
3. DIMENSIONS A AND B DO NOT INCLUDE MOLD PROTRUSION.
4. MAXIMUM MOLD PROTRUSION 0.15 (0.006) PER SIDE.
5. DIMENSION D DOES NOT INCLUDE DAMBAR PROTRUSION. ALLOWABLE DAMBAR PROTRUSION SHALL BE 0.127 (0.005) TOTAL IN EXCESS OF THE D DIMENSION AT MAXIMUM MATERIAL CONDITION.

DIM	MILLIMETERS		INCHES	
	MIN	MAX	MIN	MAX
A	9.80	10.00	0.386	0.393
B	3.80	4.00	0.150	0.157
C	1.35	1.75	0.054	0.068
D	0.35	0.49	0.014	0.019
F	0.40	1.25	0.016	0.049
G	1.27 BSC		0.050 BSC	
J	0.19	0.25	0.008	0.009
K	0.10	0.25	0.004	0.009
M	0°	7°	0°	7°
P	5.80	6.20	0.229	0.244
R	0.25	0.50	0.010	0.019

MC14020B

PACKAGE DIMENSIONS

TSSOP-16
DT SUFFIX
PLASTIC TSSOP PACKAGE
CASE 948F-01
ISSUE O

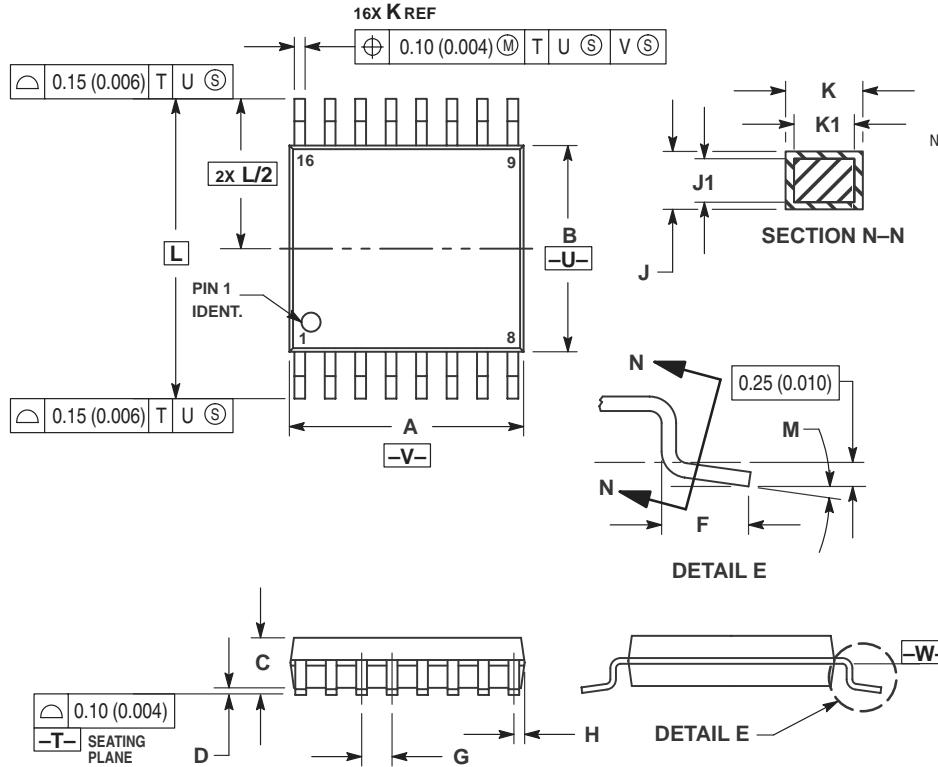

NOTES:

1. DIMENSIONING AND TOLERANCING PER ANSI Y14.5M, 1982.
2. CONTROLLING DIMENSION: MILLIMETER.
3. DIMENSION A DOES NOT INCLUDE MOLD FLASH. PROTRUSIONS OR GATE BURRS. MOLD FLASH OR GATE BURRS SHALL NOT EXCEED 0.15 (0.006) PER SIDE.
4. DIMENSION B DOES NOT INCLUDE INTERLEAD FLASH OR PROTRUSION. INTERLEAD FLASH OR PROTRUSION SHALL NOT EXCEED 0.25 (0.010) PER SIDE.
5. DIMENSION K DOES NOT INCLUDE DAMBAR PROTRUSION. ALLOWABLE DAMBAR PROTRUSION SHALL BE 0.08 (0.003) TOTAL IN EXCESS OF THE K DIMENSION AT MAXIMUM MATERIAL CONDITION.
6. TERMINAL NUMBERS ARE SHOWN FOR REFERENCE ONLY.
7. DIMENSION A AND B ARE TO BE DETERMINED AT DATUM PLANE -W-.

DIM	MILLIMETERS		INCHES	
	MIN	MAX	MIN	MAX
A	4.90	5.10	0.193	0.200
B	4.30	4.50	0.169	0.177
C	—	1.20	—	0.047
D	0.05	0.15	0.002	0.006
F	0.50	0.75	0.020	0.030
G	0.65 BSC		0.026 BSC	
H	0.18	0.28	0.007	0.011
J	0.09	0.20	0.004	0.008
J1	0.09	0.16	0.004	0.006
K	0.19	0.30	0.007	0.012
K1	0.19	0.25	0.007	0.010
L	6.40 BSC		0.252 BSC	
M	0°	8°	0°	8°

MC14020B

PACKAGE DIMENSIONS

SOEIAJ-16 F SUFFIX PLASTIC EIAJ SOIC PACKAGE CASE 966-01 ISSUE O

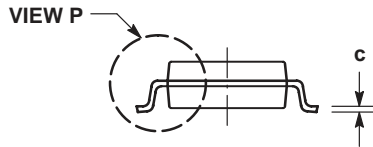
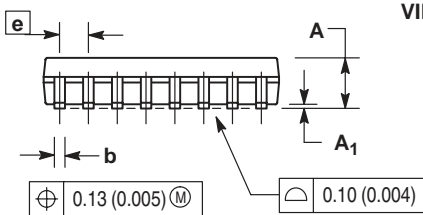
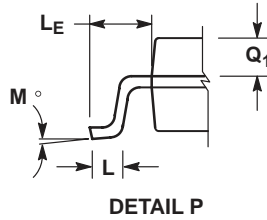
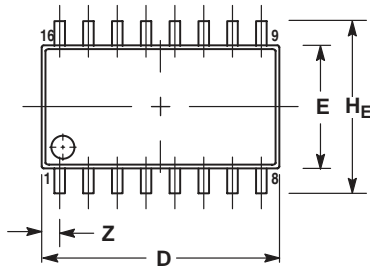

NOTES:

1. DIMENSIONING AND TOLERANCING PER ANSI Y14.5M, 1982.
2. CONTROLLING DIMENSION: MILLIMETER.
3. DIMENSIONS D AND E DO NOT INCLUDE MOLD FLASH OR PROTRUSIONS AND ARE MEASURED AT THE PARTING LINE. MOLD FLASH OR PROTRUSIONS SHALL NOT EXCEED 0.15 (0.006) PER SIDE.
4. TERMINAL NUMBERS ARE SHOWN FOR REFERENCE ONLY.
5. THE LEAD WIDTH DIMENSION (b) DOES NOT INCLUDE DAMBAR PROTRUSION. ALLOWABLE DAMBAR PROTRUSION SHALL BE 0.08 (0.003) TOTAL IN EXCESS OF THE LEAD WIDTH DIMENSION AT MAXIMUM MATERIAL CONDITION. DAMBAR CANNOT BE LOCATED ON THE LOWER RADIUS OR THE FOOT. MINIMUM SPACE BETWEEN PROTRUSIONS AND ADJACENT LEAD TO BE 0.46 (0.018).

DIM	MILLIMETERS		INCHES	
	MIN	MAX	MIN	MAX
A	—	2.05	—	0.081
A ₁	0.05	0.20	0.002	0.008
b	0.35	0.50	0.014	0.020
c	0.18	0.27	0.007	0.011
D	9.90	10.50	0.390	0.413
E	5.10	5.45	0.201	0.215
e	1.27 BSC		0.050 BSC	
HE	7.40	8.20	0.291	0.323
L	0.50	0.85	0.020	0.033
LE	1.10	1.50	0.043	0.059
M	0°	10°	0°	10°
Q ₁	0.70	0.90	0.028	0.035
Z	—	0.78	—	0.031

ON Semiconductor and  are trademarks of Semiconductor Components Industries, LLC (SCILLC). SCILLC reserves the right to make changes without further notice to any products herein. SCILLC makes no warranty, representation or guarantee regarding the suitability of its products for any particular purpose, nor does SCILLC assume any liability arising out of the application or use of any product or circuit, and specifically disclaims any and all liability, including without limitation special, consequential or incidental damages. "Typical" parameters which may be provided in SCILLC data sheets and/or specifications can and do vary in different applications and actual performance may vary over time. All operating parameters, including "Typicals" must be validated for each customer application by customer's technical experts. SCILLC does not convey any license under its patent rights nor the rights of others. SCILLC products are not designed, intended, or authorized for use as components in systems intended for surgical implant into the body, or other applications intended to support or sustain life, or for any other application in which the failure of the SCILLC product could create a situation where personal injury or death may occur. Should Buyer purchase or use SCILLC products for any such unintended or unauthorized application, Buyer shall indemnify and hold SCILLC and its officers, employees, subsidiaries, affiliates, and distributors harmless against all claims, costs, damages, and expenses, and reasonable attorney fees arising out of, directly or indirectly, any claim of personal injury or death associated with such unintended or unauthorized use, even if such claim alleges that SCILLC was negligent regarding the design or manufacture of the part. SCILLC is an Equal Opportunity/Affirmative Action Employer.

PUBLICATION ORDERING INFORMATION

NORTH AMERICA Literature Fulfillment:

Literature Distribution Center for ON Semiconductor
P.O. Box 5163, Denver, Colorado 80217 USA
Phone: 303-675-2175 or 800-344-3860 Toll Free USA/Canada
Fax: 303-675-2176 or 800-344-3867 Toll Free USA/Canada
Email: ONlit@hibbertco.com
Fax Response Line: 303-675-2167 or 800-344-3810 Toll Free USA/Canada

N. American Technical Support: 800-282-9855 Toll Free USA/Canada

EUROPE: LDC for ON Semiconductor – European Support

German Phone: (+1) 303-308-7140 (M-F 1:00pm to 5:00pm Munich Time)
Email: ONlit-german@hibbertco.com
French Phone: (+1) 303-308-7141 (M-F 1:00pm to 5:00pm Toulouse Time)
Email: ONlit-french@hibbertco.com
English Phone: (+1) 303-308-7142 (M-F 12:00pm to 5:00pm UK Time)
Email: ONlit@hibbertco.com

EUROPEAN TOLL-FREE ACCESS*: 00-800-4422-3781

*Available from Germany, France, Italy, England, Ireland

CENTRAL/SOUTH AMERICA:

Spanish Phone: 303-308-7143 (Mon-Fri 8:00am to 5:00pm MST)
Email: ONlit-spanish@hibbertco.com

ASIA/PACIFIC: LDC for ON Semiconductor – Asia Support

Phone: 303-675-2121 (Tue-Fri 9:00am to 1:00pm, Hong Kong Time)
Toll Free from Hong Kong & Singapore:
001-800-4422-3781
Email: ONlit-asia@hibbertco.com

JAPAN: ON Semiconductor, Japan Customer Focus Center

4-32-1 Nishi-Gotanda, Shinagawa-ku, Tokyo, Japan 141-8549
Phone: 81-3-5740-2745
Email: r14525@onsemi.com

ON Semiconductor Website: <http://onsemi.com>

For additional information, please contact your local Sales Representative.

[Register](#) | [Site Index](#) | [Contact Us](#) | [Home](#) | [China Site](#)

- [Press Room](#)
- [Sales & Distribution](#)
- [About Us](#)
- [Quality](#)
- [Trade Shows](#)
- [Investor Relations](#)
- [Employment](#)
- [Products](#)
 - [Product Catalog](#)
 - [New Products](#)
 - [ON/Cherry Products](#)
 - [Documentation](#)
 - [Selector Guide](#)
 - [On-line Ordering](#)
 - [Models](#)
 - [Reliability Data](#)
 - [PCN](#)
 - [Samples Search](#)
 - [Order Status](#)
 - [Tech Support](#)

Associated Documents
Item

Short Desc

Size

[Data Sheet](#)

14-Bit Binary Counter

209 kB

[Device MC14020B](#)

14-Bit Binary Counter

The MC14020B 14-stage binary counter is constructed with N-channel enhancement mode devices in a single monolithic designed with an input wave shaping circuit and 14 stages counter. The device advances the count on the negative-going. Applications include time delay circuits, counter controls, a circuits.

Features:

- Fully Static Operation
- Diode Protection on All Inputs
- Supply Voltage Range = 3.0 Vdc to 18 Vdc
- Capable of Driving Two Low-power TTL Loads or One Load Over the Rated Temperature Range
- Buffered Outputs Available from stages 1 and 4 thru 14
- Common Reset Line
- Pin-for-Pin Replacement for CD4020B

Orderable Parts

Action	Orderable Part	Short Desc.	Package Desc.	Pin Count	Caution
Order Samples	MC14020BCP	CMOS 14-Bit Binary	PDIP	16	641

N/A	MC14020BD	Counter CMOS SOIC 14-Bit Binary Counter	16	75
N/A	MC14020BDR2	Tape and Reel CMOS SOIC 14-Bit Binary Counter	16	75
N/A	MC14020BDT	CMOS TSSOP 14-Bit Binary Counter	16	94
N/A	MC14020BFEL	Tape and Reel MFP	16	96
N/A	MC14020BFL1	Tape and Reel MFP	16	96
N/A	MC14020BFL2	Tape and Reel MFP	16	96
N/A	MC14020BF	CMOS MFP 14-Bit Binary Counter	16	96
N/A	MC14020BFR1	Tape and Reel MFP	16	96

[Register](#) | [Site Index](#) | [Contact Us](#) | [Home](#) | [China Site](#)

[Products](#) | [Press Room](#) | [Sales](#) | [About](#) | [Investor](#) | [Employment](#)

© Semiconductor Components Industries, L.L.C., 1999, 2000. All rights reserved. [Terms of use.](#)