

\* = Mass durch Formkonizität nach unten verringert.  
Freimass – Toleranz nach GTA 13/5 DIN 1688

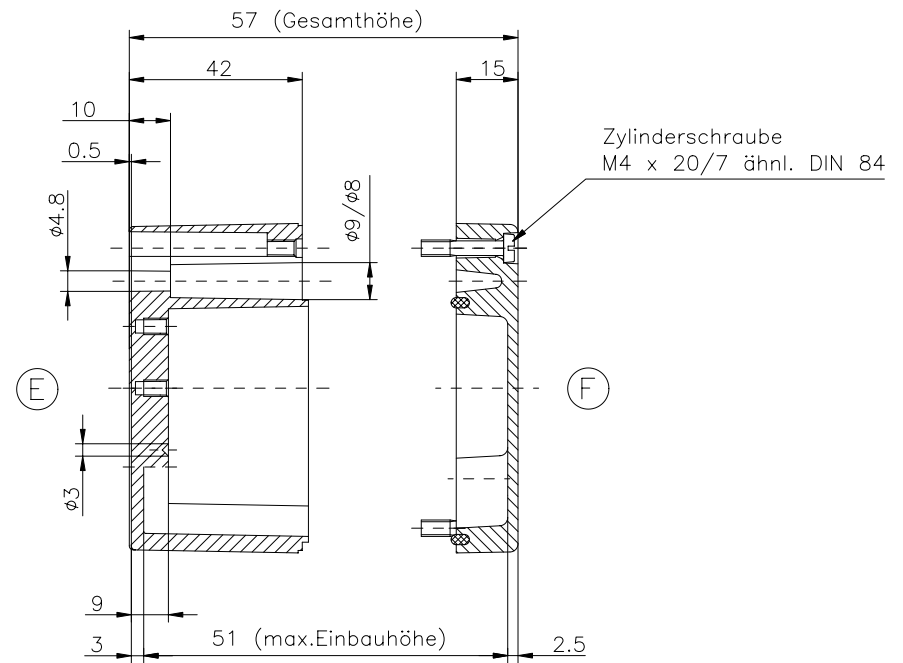
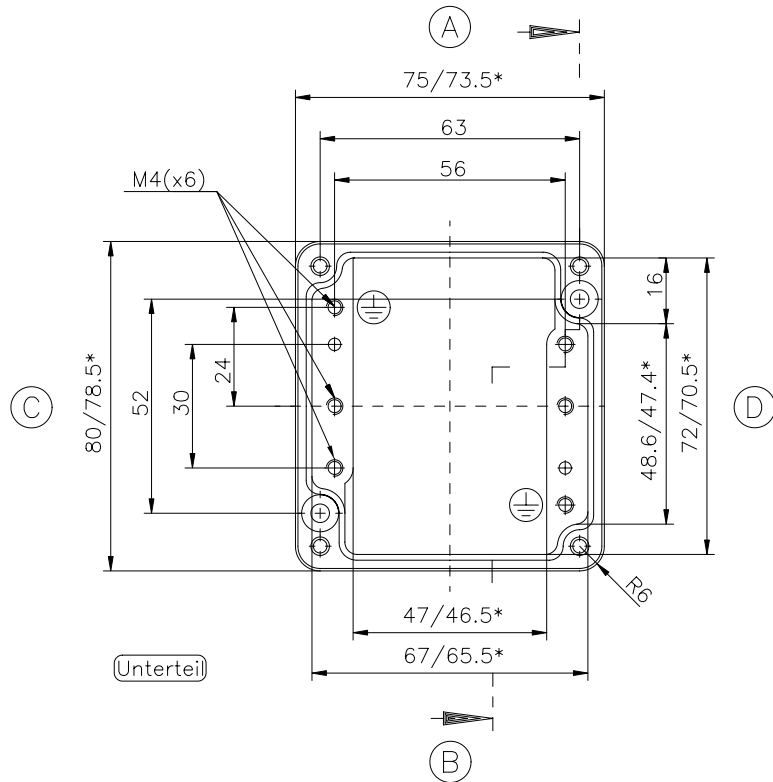

Aluminium-Standardgehäuse  
Best.Nr. 01.080806