

1-206062-7 ✓ ACTIVE

AMP | AMP CPC

TE Internal #: 1-206062-7

Unscreened, Cable Clamp & Body, .329 in [8.36 mm] Cable Entry,  
Thermoplastic, Straight, Shell Size 11, AMP CPC

[View on TE.com >](#)



Connectors > Connector Accessories > Connector Backshells > CPC Cable Clamps



Connector Backshell Product Style: **Unscreened**

Connector Backshell Product Type: **Cable Clamp & Body**

Cable Entry Diameter: **8.36 mm [ .329 in ]**

Primary Product Material: **Thermoplastic**

Body Orientation: **Straight**

[All CPC Cable Clamps \(25\)](#)

## Features

### Product Type Features

Connector Backshell Product Style	Unscreened
Connector Backshell Product Type	Cable Clamp & Body

### Body Features

Primary Product Color	Black
Primary Product Material	Thermoplastic

### Mechanical Attachment

Thread Size	5/8-24 UNEF-2B
-------------	----------------

### Housing Features

Body Orientation	Straight
Compatible With Connector Shape	Circular

### Dimensions

Cable Entry Diameter	8.36 mm [.329 in]
----------------------	-------------------



### Operation/Application

Compatible With Connector Shell Size	11
--------------------------------------	----

### Industry Standards

UL Flammability Rating	UL 94V-0
------------------------	----------

### Packaging Features

Packaging Quantity	800
Packaging Method	Bulk

### Product Compliance

[For compliance documentation, visit the product page on TE.com>](#)

EU RoHS Directive 2011/65/EU	Compliant
EU ELV Directive 2000/53/EC	Compliant
China RoHS 2 Directive MIIT Order No 32, 2016	No Restricted Materials Above Threshold
EU REACH Regulation (EC) No. 1907/2006	Current ECHA Candidate List: JUNE 2023 (235) Candidate List Declared Against: JUNE 2023 (235) Does not contain REACH SVHC
Halogen Content	BFR/CFR/PVC Free, but Br/Cl >900 ppm in other sources.
Solder Process Capability	Not applicable for solder process capability

#### Product Compliance Disclaimer

This information is provided based on reasonable inquiry of our suppliers and represents our current actual knowledge based on the information they provided. This information is subject to change. The part numbers that TE has identified as EU RoHS compliant have a maximum concentration of 0.1% by weight in homogenous materials for lead, hexavalent chromium, mercury, PBB, PBDE, DBP, BBP, DEHP, DIBP, and 0.01% for cadmium, or qualify for an exemption to these limits as defined in the Annexes of Directive 2011/65/EU (RoHS2). Finished electrical and electronic equipment products will be CE marked as required by Directive 2011/65/EU. Components may not be CE marked. Additionally, the part numbers that TE has identified as EU ELV compliant have a maximum concentration of 0.1% by weight in homogenous materials for lead, hexavalent chromium, and mercury, and 0.01% for cadmium, or qualify for an exemption to these limits as defined in the Annexes of Directive 2000/53/EC (ELV). Regarding the REACH Regulation, the information TE provides on SVHC in articles for this part number is based on the latest European Chemicals Agency (ECHA) 'Guidance on requirements for substances in articles' posted at this URL: <https://echa.europa.eu/guidance-documents/guidance-on-reach>

### Compatible Parts

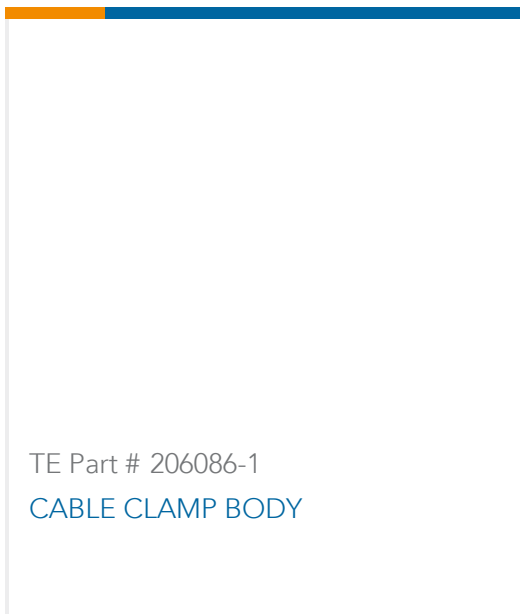
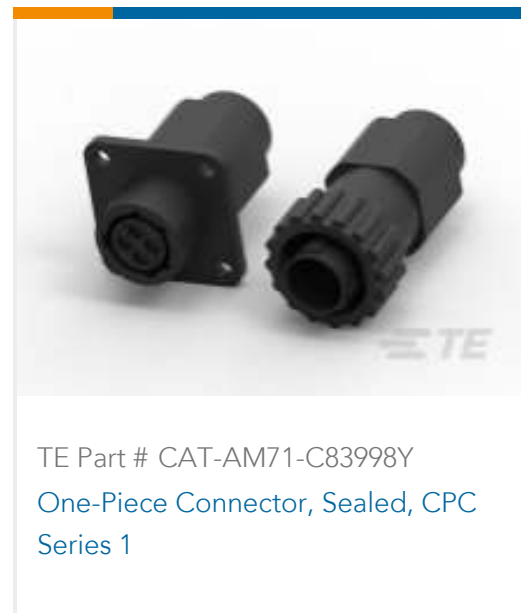

## Also in the Series | AMP CPC

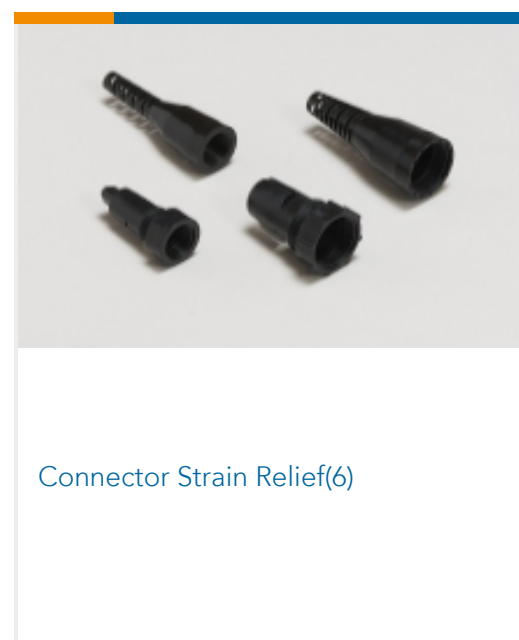
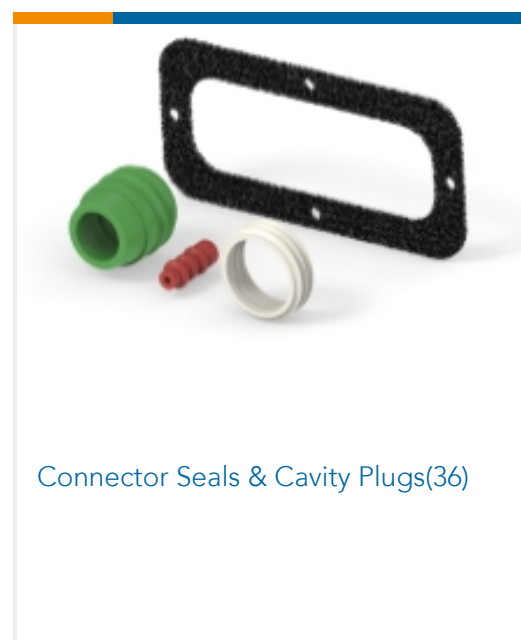
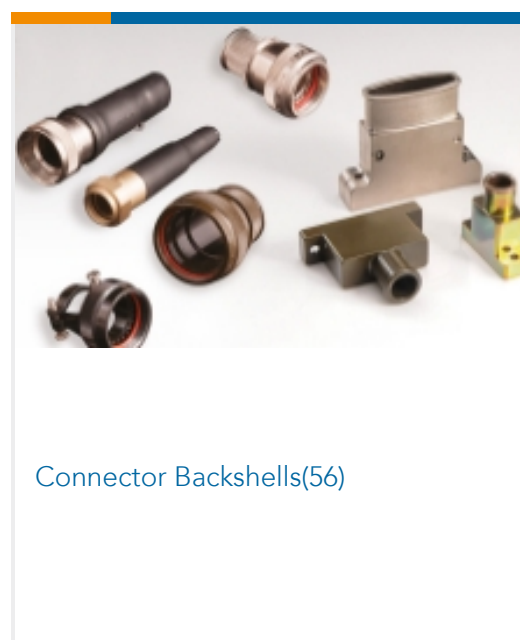
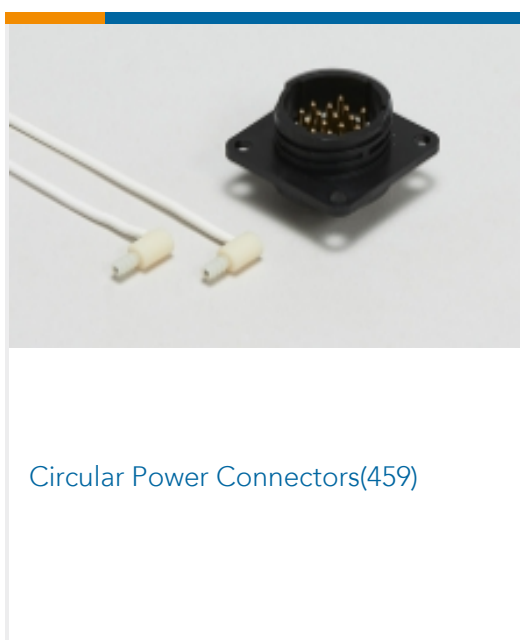
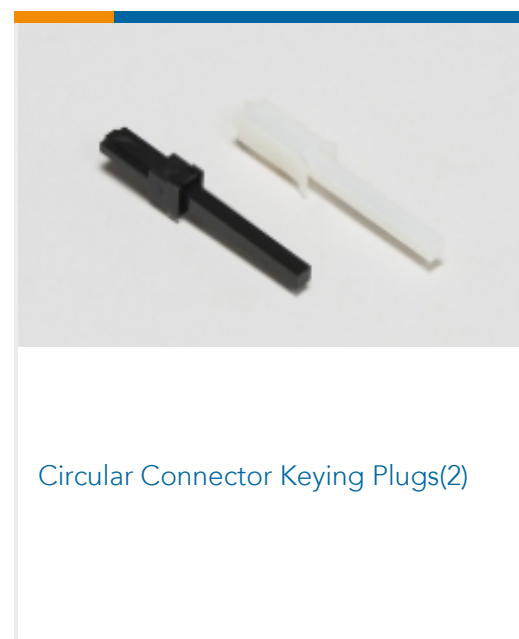
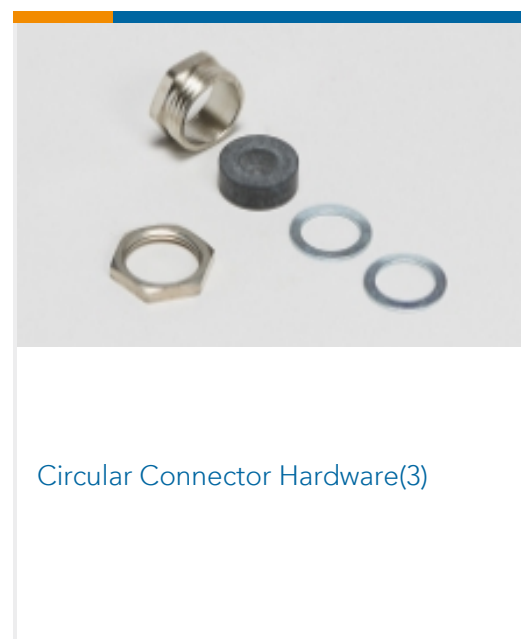
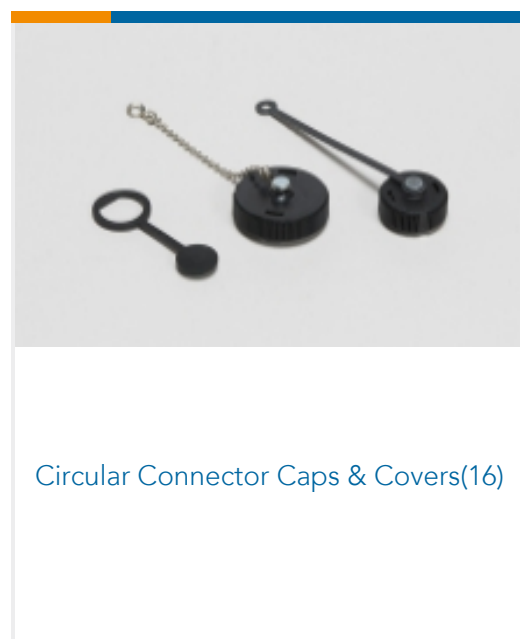
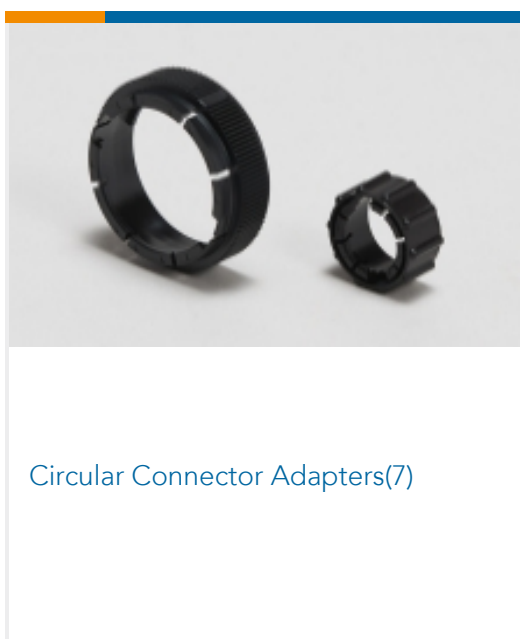



Insertion & Extraction Tools(1)



Power Contacts(6)

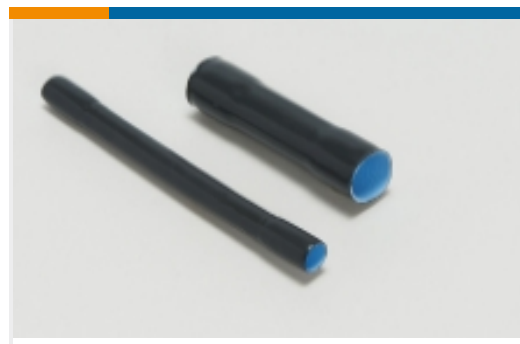

Sealing Sleeves(2)

## Customers Also Bought



TE Part #206429-1  
Circular Connector, Environmentally Sealed, CPC Series 6



TE Part #206061-1  
Cable/Panel Mount Connector, CPC Series 1



TE Part #66100-8  
III+ SKT,18-16,15AU/FL,STRIP

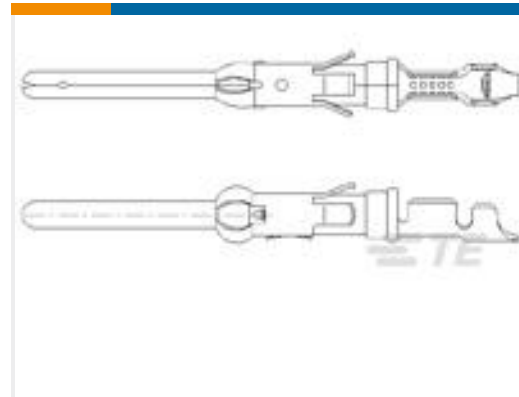

TE Part #163081-7  
.062 DIA PIN ASSY 3+



TE Part #444496-1  
HSG ASSY 2 POSN JR POWER

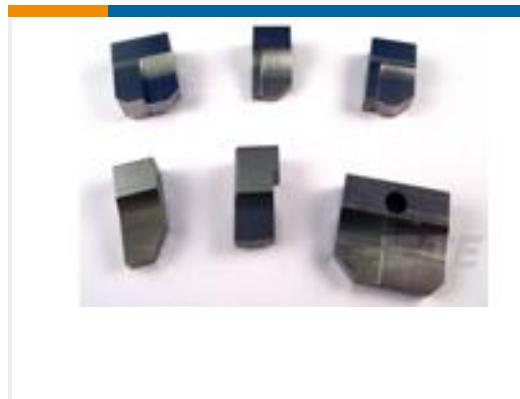

TE Part #5-240654-8  
ANVIL



TE Part #62358-1  
PIN .080 (2.03 MM) 24-20 AWG TPBR

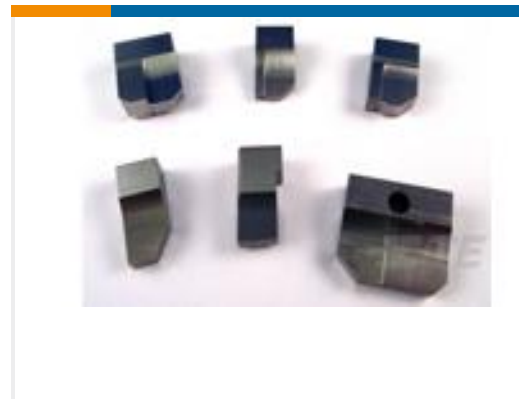

TE Part #9-690471-7  
ANVIL COMB

## Documents

### Product Drawings

[CABLE CLAMP KIT, BULK PKG](#)

English

### CAD Files

Customer View Model

[ENG\\_CVM\\_CVM\\_1-206062-7\\_W.3d\\_stp.zip](#)

English

Customer View Model

[ENG\\_CVM\\_CVM\\_1-206062-7\\_W.2d\\_dxf.zip](#)

English

[3D PDF](#)

3D

Customer View Model

[ENG\\_CVM\\_CVM\\_1-206062-7\\_W.3d\\_igs.zip](#)

English

By downloading the CAD file I accept and agree to the [Terms and Conditions](#) of use.



---

**Datasheets & Catalog Pages**

[AMP Circular Connectors for Commercial Signal & Power Applications](#)

English

---

**Product Environmental Compliance**

[Product Compliance](#)

English

[Product Compliance](#)

English