

## Photomicrosensor (Actuator Mounted) EE-SA102

**⚠ Be sure to read *Precautions* on page 25.**

### ■ Dimensions

**Note:** All units are in millimeters unless otherwise indicated.

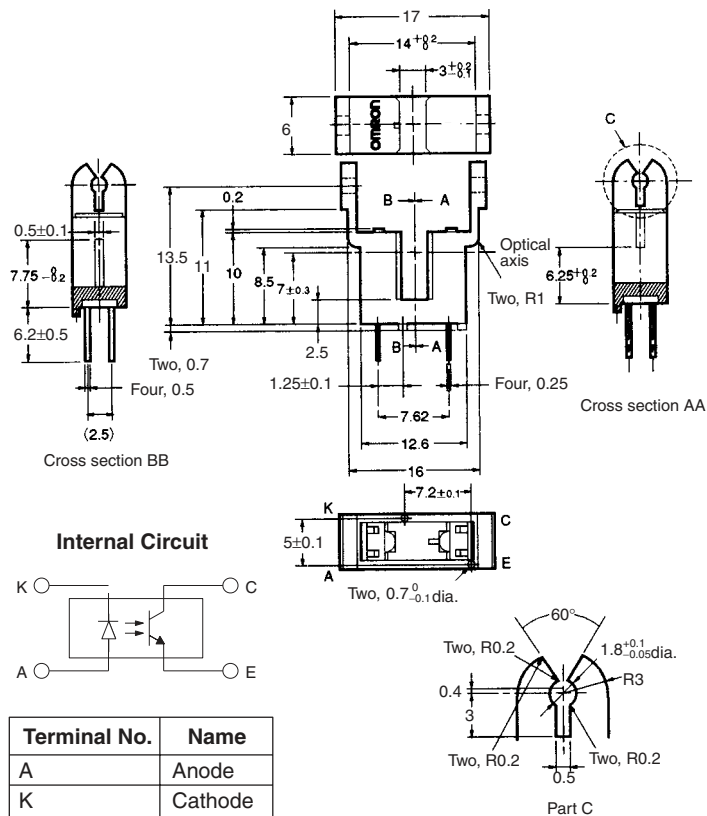

Terminal No.	Name
A	Anode
K	Cathode
C	Collector
E	Emitter

Unless otherwise specified, the tolerances are  $\pm 0.2$  mm.

### ■ Features

- An actuator can be attached.
- PCB mounting type.
- High resolution with a 0.5-mm-wide aperture.

### ■ Absolute Maximum Ratings (Ta = 25°C)

Item	Symbol	Rated value
Emitter	Forward current	$I_F$ 50 mA (see note 1)
	Pulse forward current	$I_{FP}$ 1 A (see note 2)
	Reverse voltage	$V_R$ 4 V
Detector	Collector–Emitter voltage	$V_{CEO}$ 30 V
	Emitter–Collector voltage	$V_{ECO}$ ---
	Collector current	$I_C$ 20 mA
	Collector dissipation	$P_C$ 100 mW (see note 1)
Ambient temperature	Operating	$T_{opr}$ $-25^\circ\text{C}$ to $85^\circ\text{C}$
	Storage	$T_{stg}$ $-30^\circ\text{C}$ to $100^\circ\text{C}$
Soldering temperature	$T_{sol}$	$260^\circ\text{C}$ (see note 3)

- Note:**
1. Refer to the temperature rating chart if the ambient temperature exceeds  $25^\circ\text{C}$ .
  2. The pulse width is 10  $\mu\text{s}$  maximum with a frequency of 100 Hz.
  3. Complete soldering within 10 seconds.

### ■ Electrical and Optical Characteristics (Ta = 25°C)

Item	Symbol	Value	Condition	
Emitter	Forward voltage	$V_F$ 1.2 V typ., 1.5 V max.	$I_F = 30$ mA	
	Reverse current	$I_R$ 0.01 $\mu\text{A}$ typ., 10 $\mu\text{A}$ max.	$V_R = 4$ V	
	Peak emission wavelength	$\lambda_p$ 940 nm typ.	$I_F = 20$ mA	
Detector	Light current	$I_L$ 0.5 mA min., 14 mA max.	$I_F = 20$ mA, $V_{CE} = 10$ V	
	Dark current	$I_D$ 2 nA typ., 200 nA max.	$V_{CE} = 10$ V, 0 lx	
	Leakage current	$I_{LEAK}$ ---	---	
	Collector–Emitter saturated voltage	$V_{CE(sat)}$	0.1 V typ., 0.4 V max.	$I_F = 20$ mA, $I_L = 0.1$ mA
	Peak spectral sensitivity wavelength	$\lambda_p$	850 nm typ.	$V_{CE} = 10$ V
Rising time	$t_r$	4 $\mu\text{s}$ typ.	$V_{CC} = 5$ V, $R_L = 100$ $\Omega$ , $I_L = 5$ mA	
Falling time	$t_f$	4 $\mu\text{s}$ typ.	$V_{CC} = 5$ V, $R_L = 100$ $\Omega$ , $I_L = 5$ mA	

Engineering Data

Forward Current vs. Collector Dissipation Temperature Rating

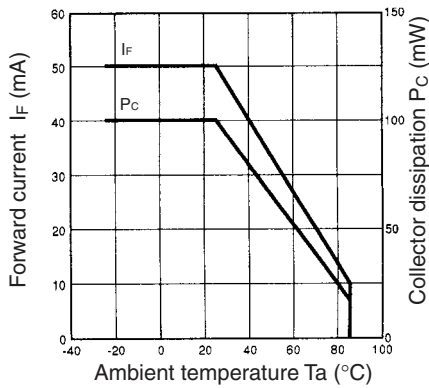

Forward Current vs. Forward Voltage Characteristics (Typical)

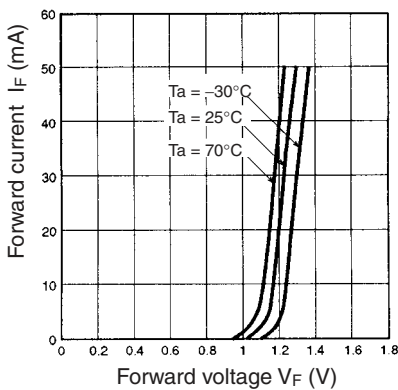

Light Current vs. Forward Current Characteristics (Typical)

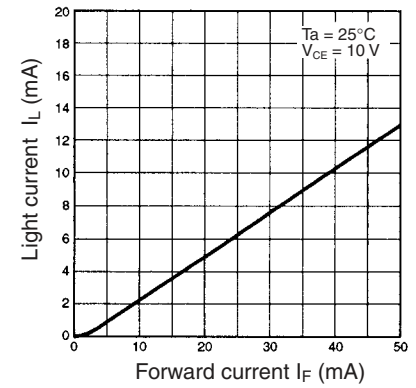

Light Current vs. Collector-Emitter Voltage Characteristics (Typical)

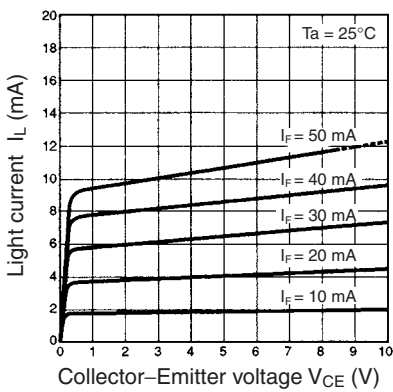

Relative Light Current vs. Ambient Temperature Characteristics (Typical)

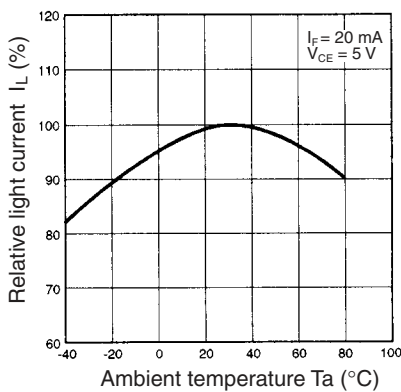

Dark Current vs. Ambient Temperature Characteristics (Typical)

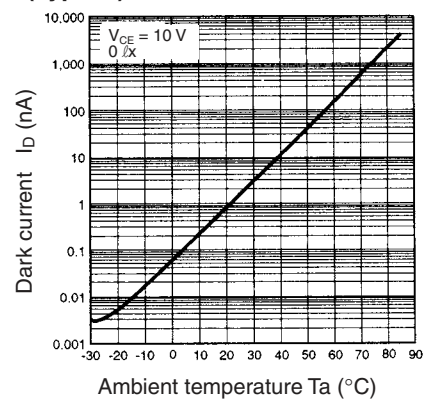

Response Time vs. Load Resistance Characteristics (Typical)

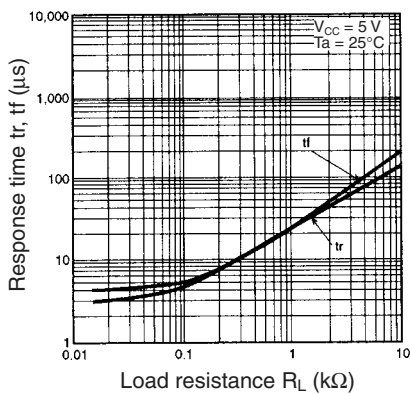

Sensing Position Characteristics (Typical)

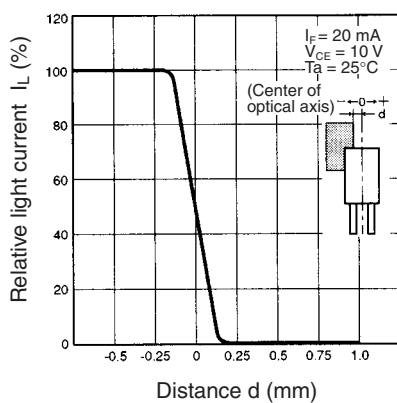

Sensing Position Characteristics (Typical)

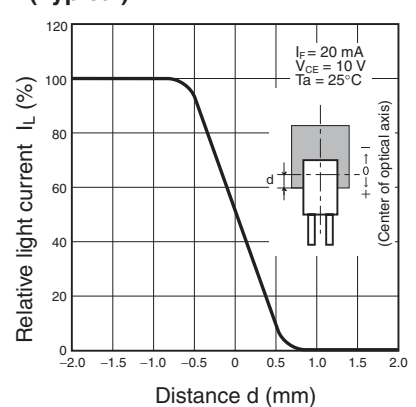

Response Time Measurement Circuit

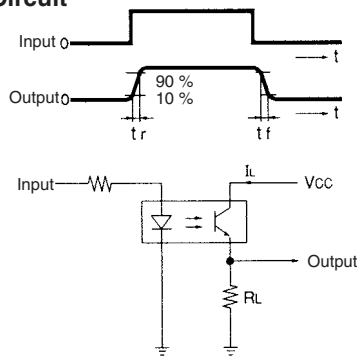

Actuator Dimensions

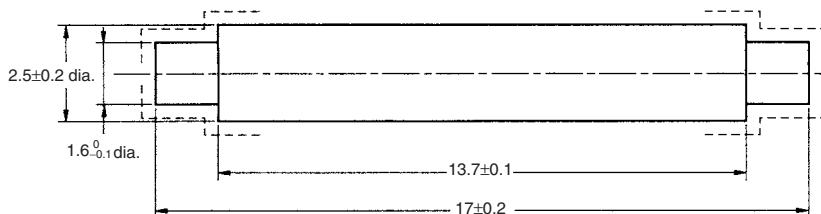

- Note:
1. Make sure that the portions marked with dotted lines have no burrs.
  2. The material of the actuator must be selected by considering the infrared permeability of the actuator.