

OSFP-8SFP28-PDAC3M-C

MSA and TAA Compliant 200GBase-CU OSFP to 8xSFP28 Direct Attach Cable (Passive Twinax, 3m)

Features

- OSFP MSA compliant
- 8 parallel full-duplex channels
- Compliant to IEEE802.3BJ
- Pluggable/Direct Attach
- Wire Gauge: 30 AWG
- 3m Length
- High-Speed Cable Assembly
- RoHS compliant



Applications

- 200G Ethernet

Product Description

This is an MSA compliant 200GBase-CU OSFP to 8xSFP28 direct attach cable that operates over passive copper with a maximum reach of 3.0m (9.8ft). It has been programmed, uniquely serialized, and data-traffic and application tested to ensure it is 100% compliant and functional. This direct attach cable is TAA (Trade Agreements Act) compliant, and is built to comply with MSA (Multi-Source Agreement) standards. We stand behind the quality of our products and proudly offer a limited lifetime warranty.

ProLabs' direct attach cables are RoHS compliant and lead-free.

TAA refers to the Trade Agreements Act (19 U.S.C. & 2501-2581), which is intended to foster fair and open international trade. TAA requires that the U.S. Government may acquire only "U.S. – made or designated country end products."



General Characteristics

Parameter	Specification
Product Type Features	
Cable Assembly Category	High Speed
Cable Assembly Type	Pluggable/Direct Attach
Connector End 1 Type	OSFP
Connector End 2 Type	SFP28 (8)
Assembly Color	Black
Cable Assembly Length	3m (9.8ft)
Electrical Characteristics	
Isolation Resistance	100 Ω
Conductor Resistance	2 Ω Max.
Voltage	5V
Dimensions	
Wire Gauge	30 AWG
Body Features	
Jacket Material	PVC

OSFP Electrical Pin-out Assignment

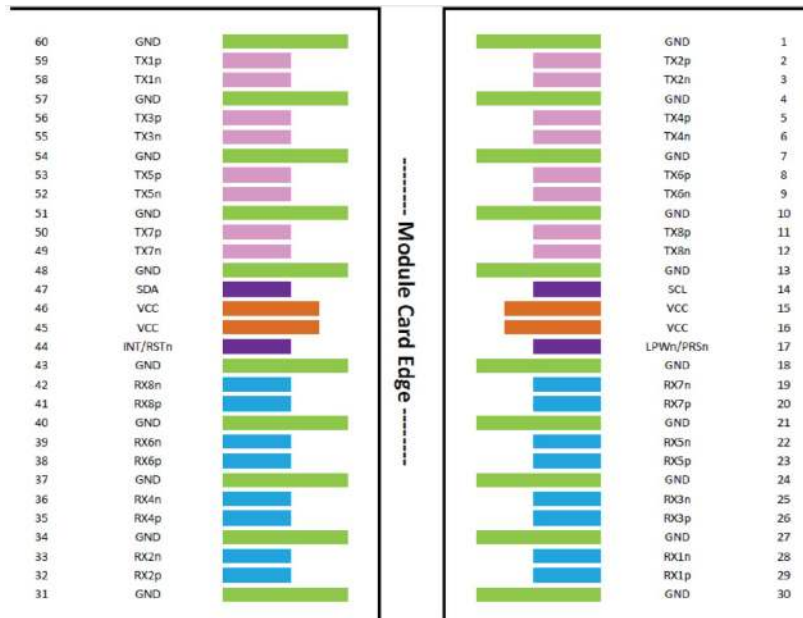

OSFP Pin Descriptions

Pin #	Symbol	Description	Logic	Direction	Plug Sequence
1	GND		Ground		1
2	TX2p	Transmitter Data Non-Inverted	CML-I	Input from Host	3
3	TX2n	Transmitter Data Inverted	CML-I	Input from Host	3
4	GND		Ground		1
5	TX4p	Transmitter Data Non-Inverted	CML-I	Input from Host	3
6	TX4n	Transmitter Data Inverted	CML-I	Input from Host	3
7	GND		Ground		1
8	TX6p	Transmitter Data Non-Inverted	CML-I	Input from Host	3
9	TX6n	Transmitter Data Inverted	CML-I	Input from Host	3
10	GND		Ground		1
11	TX8p	Transmitter Data Non-Inverted	CML-I	Input from Host	3
12	TX8n	Transmitter Data Inverted	CML-I	Input from Host	3
13	GND		Ground		1
14	SCL	2-wire Serial interface clock	LVC MOS-I/O	Bi-directional	3
15	VCC	+3.3V Power		Power from Host	2
16	VCC	+3.3V Power		Power from Host	2
17	LPWn/PRSn	Low-Power Mode / Module Present	Multi-Level	Bi-directional	3
18	GND		Ground		1
19	RX7n	Receiver Data Inverted	CML-O	Output to Host	3
20	RX7p	Receiver Data Non-Inverted	CML-O	Output to Host	3
21	GND		Ground		1
22	RX5n	Receiver Data Inverted	CML-O	Output to Host	3
23	RX5p	Receiver Data Non-Inverted	CML-O	Output to Host	3
24	GND		Ground		1
25	RX3n	Receiver Data Inverted	CML-O	Output to Host	3
26	RX3p	Receiver Data Non-Inverted	CML-O	Output to Host	3
27	GND		Ground		1
28	RX1n	Receiver Data Inverted	CML-O	Output to Host	3
29	RX1p	Receiver Data Non-Inverted	CML-O	Output to Host	3
30	GND		Ground		1
31	GND		Ground		1
32	RX2p	Receiver Data Non-Inverted	CML-O	Output to Host	3
33	RX2n	Receiver Data Inverted	CML-O	Output to Host	3
34	GND		Ground		1
35	RX4p	Receiver Data Non-Inverted	CML-O	Output to Host	3
36	RX4n	Receiver Data Inverted	CML-O	Output to Host	3
37	GND		Ground		1
38	RX6p	Receiver Data Non-Inverted	CML-O	Output to Host	3

Pin #	Symbol	Description	Logic	Direction	Plug Sequence
39	RX6n	Receiver Data Inverted	CML-O	Output to Host	3
40	GND		Ground		1
41	RX8p	Receiver Data Non-Inverted	CML-O	Output to Host	3
42	RX8n	Receiver Data Inverted	CML-O	Output to Host	3
43	GND		Ground		1
44	INT/RSTn	Module Interrupt / Module Reset	Multi-Level	Bi-directional	3
45	VCC	+3.3V Power		Power from Host	2
46	VCC	+3.3V Power		Power from Host	2
47	SDA	2-wire Serial interface data	LVC MOS-I/O	Bi-directional	3
48	GND		Ground		1
49	TX7n	Transmitter Data Inverted	CML-I	Input from Host	3
50	TX7p	Transmitter Data Non-Inverted	CML-I	Input from Host	3
51	GND		Ground		1
52	TX5n	Transmitter Data Inverted	CML-I	Input from Host	3
53	TX5p	Transmitter Data Non-Inverted	CML-I	Input from Host	3
54	GND		Ground		1
55	TX3n	Transmitter Data Inverted	CML-I	Input from Host	3
56	TX3p	Transmitter Data Non-Inverted	CML-I	Input from Host	3
57	GND		Ground		1
58	TX1n	Transmitter Data Inverted	CML-I	Input from Host	3
59	TX1p	Transmitter Data Non-Inverted	CML-I	Input from Host	3
60	GND		Ground		1

SFP28 Electrical Pin-out Assignment

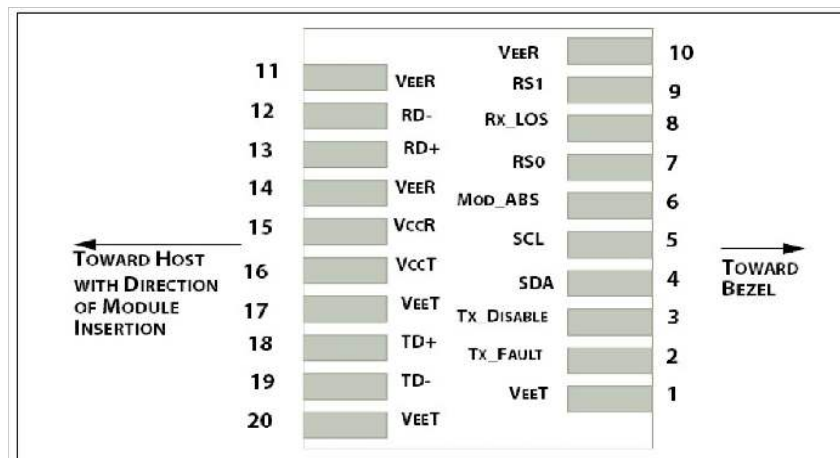

SFP28 Pin Descriptions

Pin	Logic	Symbol	Name/Descriptions	Ref.
1		VeeT	Module Transmitter Ground	1
2	LVTTTL-O	Tx_Fault	Transmitter Fault	2
3	LVTTTL-I	Tx_Disable	Transmitter Disable	3
4	LVTTTL-I/O	SDA	MOD-DEF2 2-wire serial interface data line	4
5	LVTTTL-I/O	SCL	MOD-DEF1 2-wire serial interface clock line	4
6		Mod_Abs	Module Absent	5
7	LVTTTL-I	RS0	Rate Select Zero	
8	LVTTTL- O	Rx_LOS	Module Receiver Loss of Signal	2
9	LVTTTL-I	RS1	Rate Select One	
10		VeeR	Module Receiver Ground	1
11		VeeR	Module Receiver Ground	1
12	CML-O	RD-	Receiver Inverted Data Output	
13	CML-O	RD+	Receiver Non-Inverted Data Output	
14		VeeR	Module Receiver Ground	1
15		VccR	Module Receiver 3.3V Supply	
16		VccT	Module Transmitter 3.3V Supply	
17		VeeT	Module Transmitter Ground	1
18	CML-I	TD+	Transmitter Non-Inverted Data Input	
19	CML-I	TD-	Transmitter Inverted Data Input	
20		VeeT	Module Transmitter Ground	1

Notes:

1. The module signal grounds, VeeR and VeeT, shall be isolated from the module case.
2. This is an open collector/drain output and shall be pulled up with 4.7-10k to Vcc_Host on the host board. Pull ups can be connected to multiple power supplies, however the host board design shall ensure that no module has voltage exceeding module VccT/R + 0.5 V.
3. This is an open collector/drain input and shall be pulled up with 4.7-10k to VccT in the module.
4. See 2-wire electrical specification.
5. This shall be pulled up with 4.7-10k to Vcc_Host on the host board.

Wiring Table

CONN-P0		SHIELD BRAIDING	CONN-P1—P8	
SHELL			SHELL	
GND		○	P12	Rn
TX1n	P58		P13	Rdp
TX1p	P59	○		GND(RX)
GND				GND(TX)
GND		○	P18	Tdp
RX1p	P29		P19	Tdn
RX1n	P28	○		GND(TX)
GND				GND(RX)
GND		○	P12	Rn
TX2n	P3		P13	Rdp
TX2p	P2	○		GND(RX)
GND				GND(TX)
GND		○	P18	Tdp
RX2p	P32		P19	Tdn
RX2n	P33	○		GND(TX)
GND				GND(RX)
GND		○	P12	Rn
TX3n	P55		P13	Rdp
TX3p	P56	○		GND(RX)
GND				GND(TX)
GND		○	P18	Tdp
RX3p	P26		P19	Tdn
RX3n	P25	○		GND(TX)
GND				GND(RX)
GND		○	P12	Rn
TX4n	P6		P13	Rdp
TX4p	P5	○		GND(RX)
GND				GND(TX)
GND		○	P18	Tdp
RX4p	P35		P19	Tdn
RX4n	P36	○		GND(TX)
GND				GND(RX)

CONN-P0		SHIELD BRAIDING	CONN-P1—P8	
SHELL			SHELL	
GND		○	P12	Rn
TX5n	P52		P13	Rdp
TX5p	P53	○		GND(RX)
GND				GND(TX)
GND		○	P18	Tdp
RX5p	P23		P19	Tdn
RX5n	P22	○		GND(TX)
GND				GND(RX)
GND		○	P12	Rn
TX6n	P9		P13	Rdp
TX6p	P8	○		GND(RX)
GND				GND(TX)
GND		○	P18	Tdp
RX6p	P38		P19	Tdn
RX6n	P39	○		GND(TX)
GND				GND(RX)
GND		○	P12	Rn
TX7n	P49		P13	Rdp
TX7p	P50	○		GND(RX)
GND				GND(TX)
GND		○	P18	Tdp
RX7p	P20		P19	Tdn
RX7n	P19	○		GND(TX)
GND				GND(RX)
GND		○	P12	Rn
TX8n	P12		P13	Rdp
TX8p	P11	○		GND(RX)
GND				GND(TX)
GND		○	P18	Tdp
RX8p	P41		P19	Tdn
RX8n	P42	○		GND(TX)
GND				GND(RX)

Wire Gauge and Bend Radius

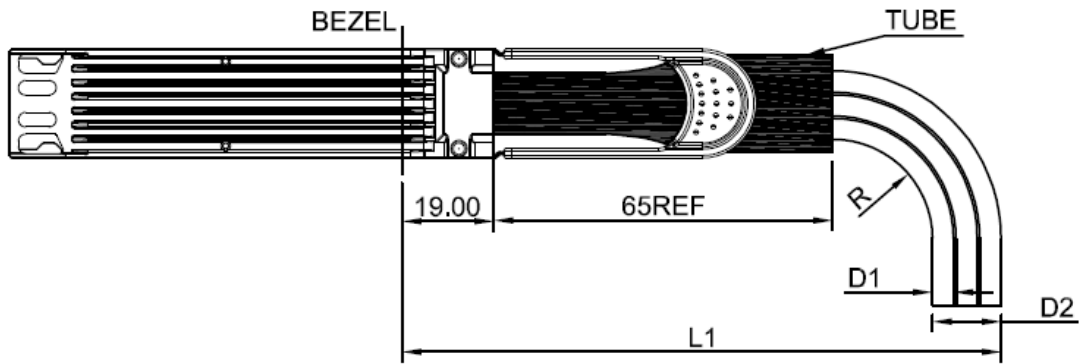

OSFP (Vertical Direction)				
CABLE GUAGE	DIAMETER "D1"	DIAMETER "D2"	MIN.BEND RADIUS "R"	MIN.BEND SPACE "L1"
30AWG	4.1MM	12.3MM	21MM	118MM

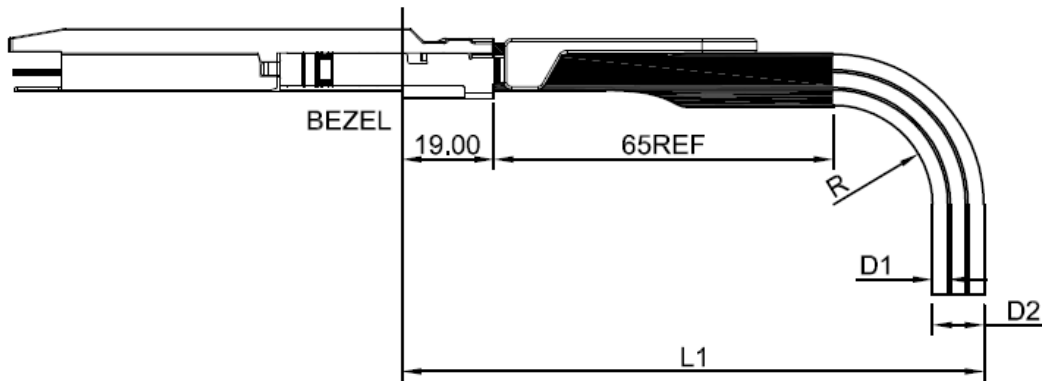

OSFP (Horizontal Direction)				
CABLE GUAGE	DIAMETER "D1"	DIAMETER "D2"	MIN.BEND RADIUS "R1"	MIN.BEND SPACE "L1"
30AWG	4.1MM	12.3MM	21MM	118MM

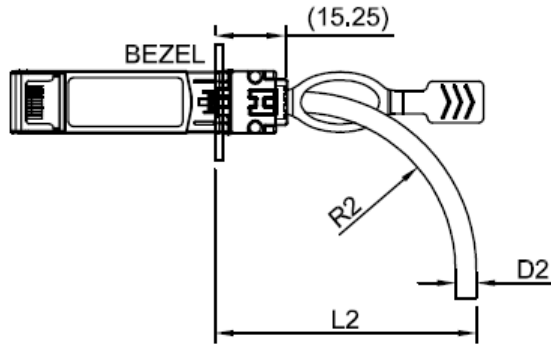

SFP28 (Horizontal Directlon)			
CABLE GUAGE	DIAMETER "D2"	MIN.BEND RADIUS "R2"	MIN.BEND SPACE "L2"
30AWG	4.1MM	20MM	40MM

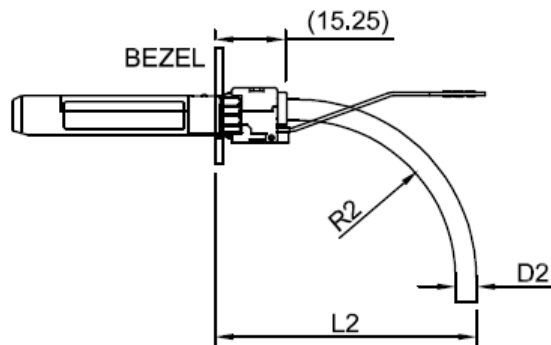

SFP28 (Vertical Directlon)			
CABLE GUAGE	DIAMETER "D2"	MIN.BEND RADIUS "R2"	MIN.BEND SPACE "L2"
30AWG	4.1MM	20MM	40MM

Mechanical Specifications

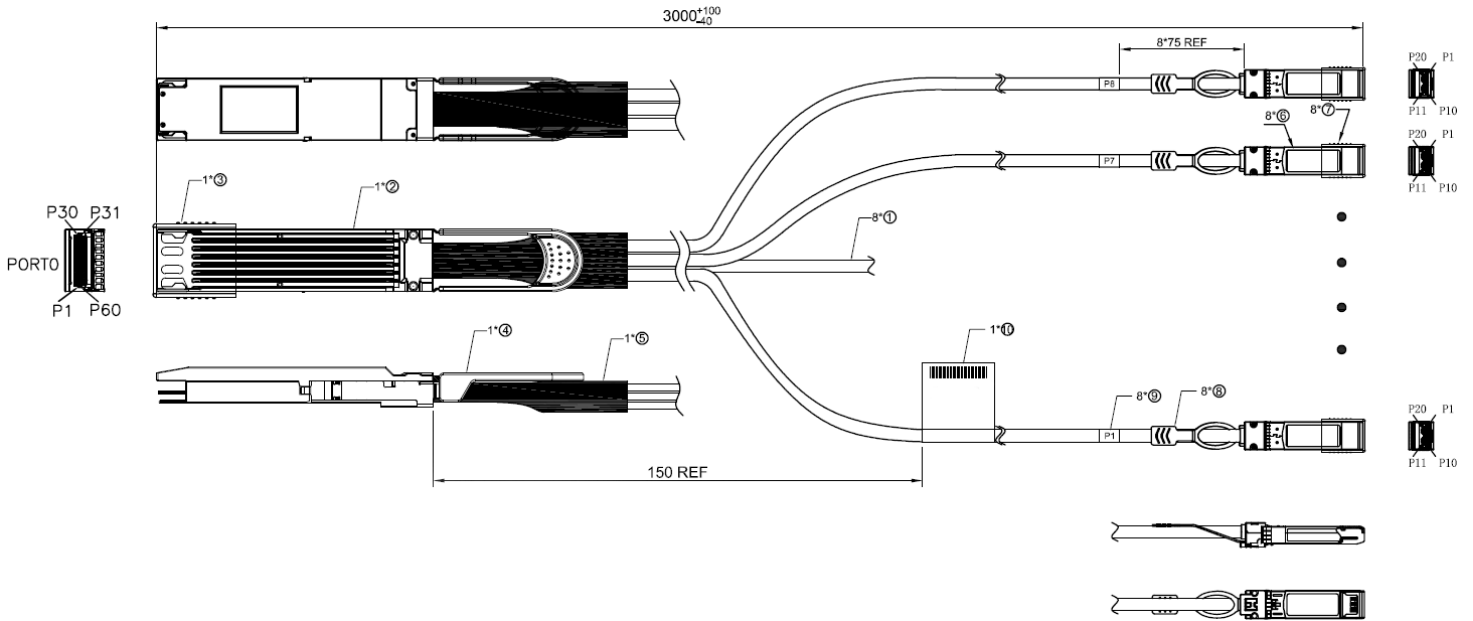

Item	Name	Description	Quantity	Unit
1	Cable	SFP28 2P PVC	A/R	mm
2	Plug 1	OSFP Plug, Reference OSFP MSA 3.0	1	PCS
3	Dust Cap 1	OSFP Dust Cap Black	1	PCS
4	Pull Tab 1	Stainless Steel + TPV, White	1	PCS
5	HST	Heat Shrink Tube, Black	1	PCS
6	Plug 2	SFP28 Plug	8	PCS
7	Dust Cap 2	SFP28 Dust Cap Blue	8	PCS
8	Pull Tab 2	SFP28 Latch PA66 Black	8	PCS
9	Label 1	15x35mm, White	8	PCS
10	Label 2	26x57mm, White	1	PCS

OSFP

SFP28 Side

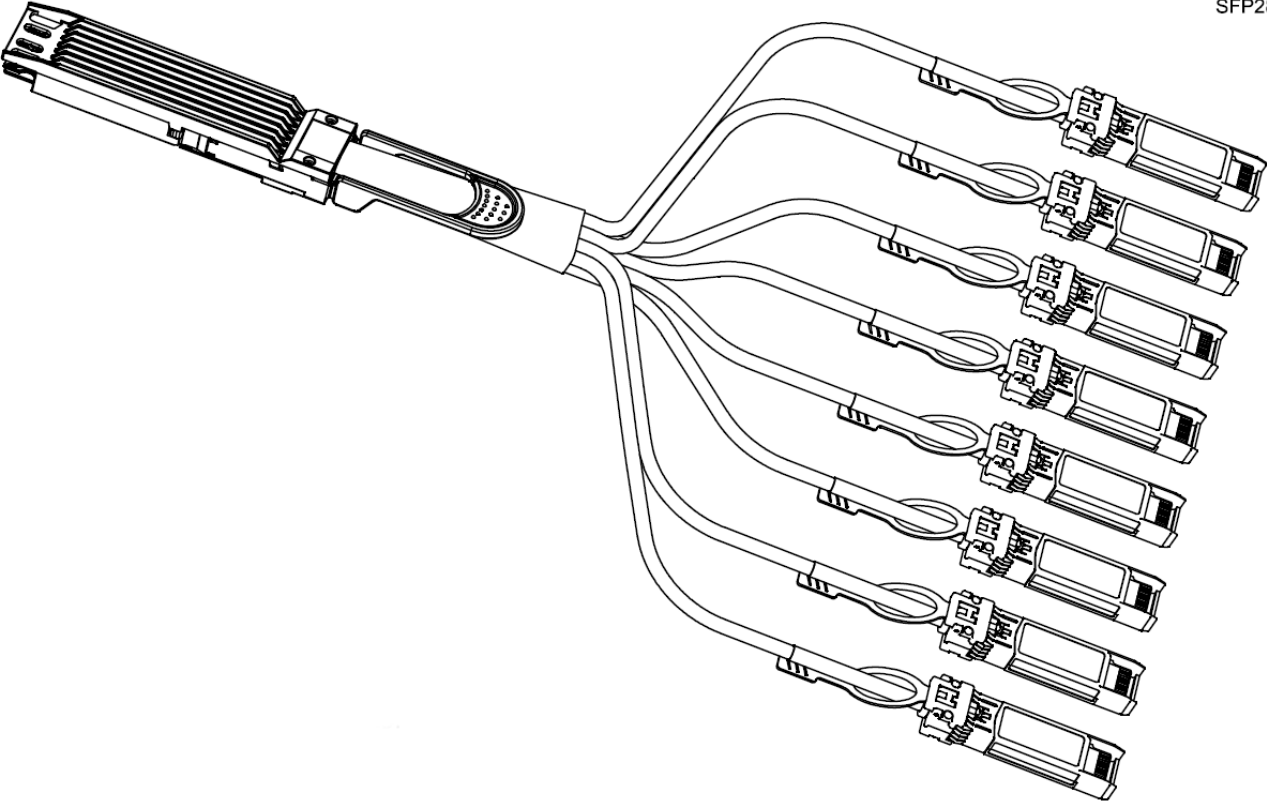

About ProLabs

Our experience comes as standard; for over 15 years ProLabs has delivered optical connectivity solutions that give our customers freedom and choice through our ability to provide seamless interoperability. At the heart of our company is the ability to provide state-of-the-art optical transport and connectivity solutions that are compatible with over 90 optical switching and transport platforms.

Complete Portfolio of Network Solutions

ProLabs is focused on innovations in optical transport and connectivity. The combination of our knowledge of optics and networking equipment enables ProLabs to be your single source for optical transport and connectivity solutions from 100Mb to 400G while providing innovative solutions that increase network efficiency. We provide the optical connectivity expertise that is compatible with and enhances your switching and transport equipment.

Trusted Partner

Customer service is our number one value. ProLabs has invested in people, labs and manufacturing capacity to ensure that you get immediate answers to your questions and compatible product when needed. With Engineering and Manufacturing offices in the U.K. and U.S. augmented by field offices throughout the U.S., U.K. and Asia, ProLabs is able to be our customers best advocate 24 hours a day.

Contact Information

ProLabs US

Email: sales@prolabs.com

Telephone: 952-852-0252

ProLabs UK

Email: salessupport@prolabs.com

Telephone: +44 1285 719 600