



A Product Line of
Diodes Incorporated



SPECIFICATION FOR APPROVAL

CUSTOMER _____

NOMINAL FREQUENCY 100.000000 MHz

HOLDER TYPE TYPE SQ 5.0x3.2 SEAM SEALED CRYSTAL CLOCK OSCILLATOR

SPEC. NO. (P/N) SQA000001Z

CUSTOMER P/N _____

ISSUE DATE August 26, 2018

VERSION C

APPROVED	PREPARED	QA

Diodes Incorporated

No.2, Tzu-Chiang 5th Rd, Chung Li Industrial Park,
Chung Li City, Taoyuan County, Taiwan (R.O.C.)
TEL: 886-3-451-8888
FAX: 886-3-461-3865
<https://www.diodes.com>

- *RoHS Compliant
- *HF-Halogen Free
- *REACH Compliant

TYPE SQ 5.0x3.2 SEAM SEALED CRYSTAL CLOCK OSCILLATOR

SQA000001Z

VER. C 26-Aug-18

ELECTRICAL SPECIFICATIONS

SRe Part Number : SQA000001Z

Item	Symbol	Specifications	Units	Notes
Nominal Frequency	Fo	100.000000	MHz	
Frequency Stability	FT	± 50	ppm	**See note
Operating Temperature Range	TR	-40 to +85	°C	
Supply Voltage	V _{CC}	+3.3 ± 10.0%	V	
Logic Type	LT	HCSL		
Supply Current, Output Enabled	I _{CC/OE}	40	mA	Max.
Supply Current, Output Disabled	I _{CC/OD}	10	uA	Max.
Duty Cycle (Symmetry)	DC/SY	45 / 55	%	Measured 50% of Waveform
Rise / Fall Time	T _R /T _F	0.5	ns	Max. measured from Vol=0.175V to Voh=0.525V
Output Voltage "0" Level	V _{OL}	-0.150	V	Min.
Output Voltage "1" Level	V _{OH}	0.900	V	Max.
Output Load		Rs=33Ω, Rp=50Ω, CL=2pF		Typ. In HCSL termination
Output Phase Jitter-PCIe Gen2		2.5	ps RMS	Max.
Output Phase Jitter-PCIe Gen3		1	ps RMS	Max.
Jitter, Phase	RMS	1	ps	Max. 12KHz ~ 20MHz Frequency Band
Jitter, Accumulated	RMS(1-σ)	7	ps	Typ. 20,000 Consecutive Periods
Jitter, Peak to Peak	Pk-Pk	40	ps	Max. 100,000 Random Periods
Start Up Time		10	ms	Max.
Storage Temperature Range		-55 to +125	°C	

※ This product doesn't include harmful substance that stipulated by SONY SS-00259 Level 1 and S-AT2-001 Level 1 standard. RoHS Compliant (Pb - Free).

**Stability includes all combinations of Operating Temperature, Load changes, rated Input (Supply) Voltage changes, Initial Calibration Tolerance (25°C), Aging (5 years at 40°C Average Effective Ambient Temperature), Shock and Vibration.

OUTPUT ENABLE / DISABLE

Parameter	Min.	Typ.	Max.	Units	Notes
Input Voltage (Pin1), Output Enable	0.7V _{DD}			V	Or Open
Input Voltage (Pin1), Output Disable (low power standby)			0.3V _{DD}	V	Output is Hi-Z
Output Disable Delay			200	ns	
Output Enable Delay			2	ms	



TYPE SQ 5.0x3.2 SEAM SEALED CRYSTAL CLOCK OSCILLATOR

SQA000001Z

VER. C 26-Aug-18

TEST CIRCUIT

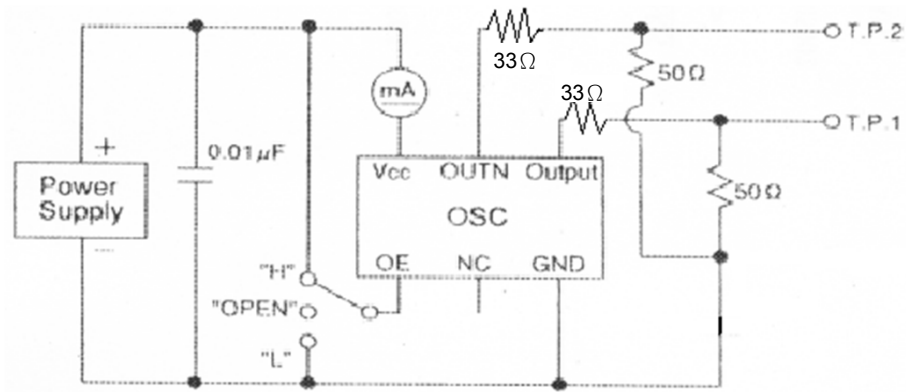

OUTPUT WAVEFORM

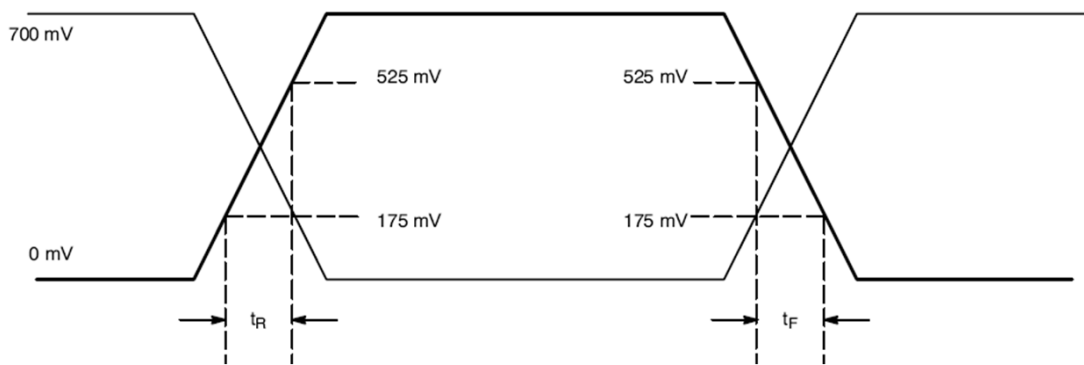

TYPE SQ 5.0x3.2 SEAM SEALED CRYSTAL CLOCK OSCILLATOR

SQA000001Z

VER. C 26-Aug-18

RELIABILITY SPECIFICATIONS

ENVIRONMENTAL:

- a) THERMAL SHOCK: MIL-STD-883, Method 1011, Condition A
- b) MOISTURE RESISTANCE: MIL-STD-883, Method 1004
- c) VIBRATION: MIL-STD-883, Method 2007, Condition A
- d) RESISTANCE TO SOLDERING HEAT: J-STD-020D Table 5-2 Pb-free devices
(except 2 cycles max)
- e) HAZARDOUS SUBSTANCE: RoHS Compliant

MECHANICAL:

- a) SHOCK: MIL-STD-883, Method 2002, Condition B
- b) SOLDERABILITY: JESD22-B102-D Method 2 (Preconditioning E)
- c) TERMINAL STRENGTH: MIL-STD-883, Method 2004, Test Condition D
- d) GROSS LEAK: MIL-STD-883, Method 1014, Condition C
- e) FINE LEAK: MIL-STD-883, Method 1014, Condition A2, $R1=2 \times 10^{-8}$ atm cc/s
- f) SOLVENT RESISTANCE: MIL-STD-202, Method 215

SUGGESTED IR REFLOW PROFILE

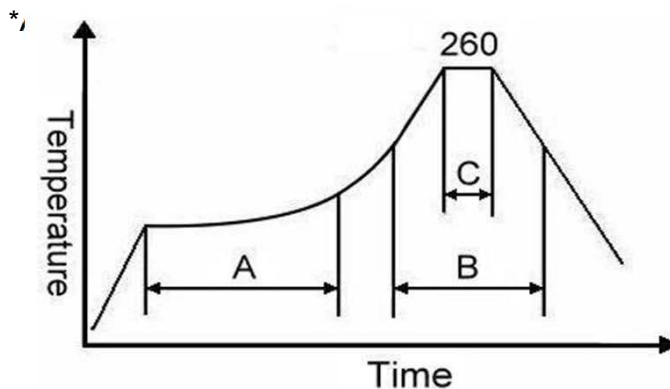

Note:

	Stage	Temperature	Time
A	Preheat	150~200°C	60~120 Sec
B	Primary Heat	217°C	60~150 Sec
C	Peak	260°C	10 Sec

TYPE SQ 5.0x3.2 SEAM SEALED CRYSTAL CLOCK OSCILLATOR

SQA000001Z

VER. C 26-Aug-18

MARKING

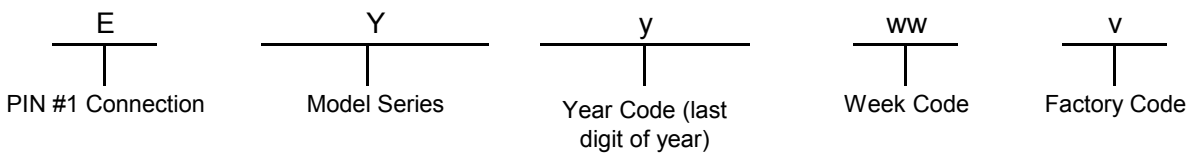
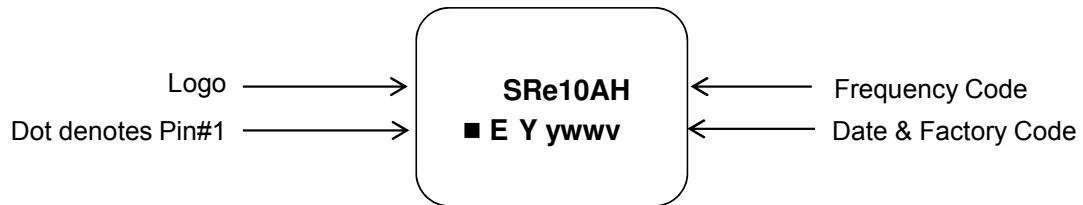

MECHANICAL DRAWINGS (Scale:None. Dimensions are in mm.)

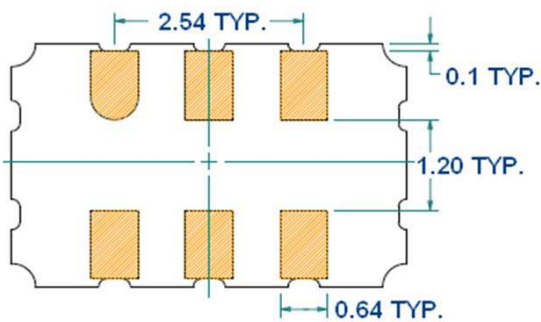
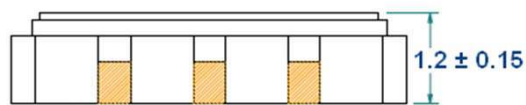
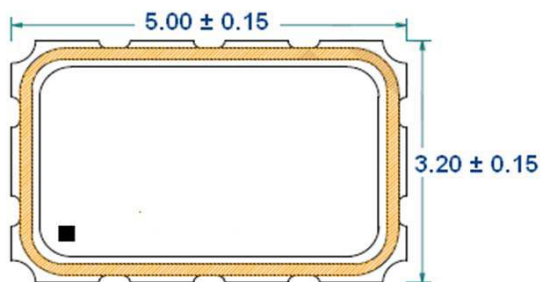

Recommended Land Pattern*

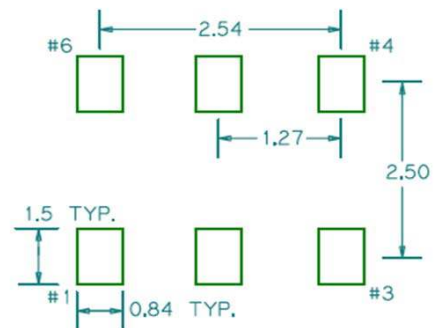

*External high-frequency power decoupling is recommended. (see test circuit for minimum recommendation). To ensure optimal performance, do not route traces beneath the package.

Pin	Function
1	OE
2	NC
3	V _{EE}
4	OUTPUT
5	OUTPUT N
6	V _{CC}

TYPE SQ 5.0x3.2 SEAM SEALED CRYSTAL CLOCK OSCILLATOR

SQA000001Z

VER. C 26-Aug-18

TAPE&REEL

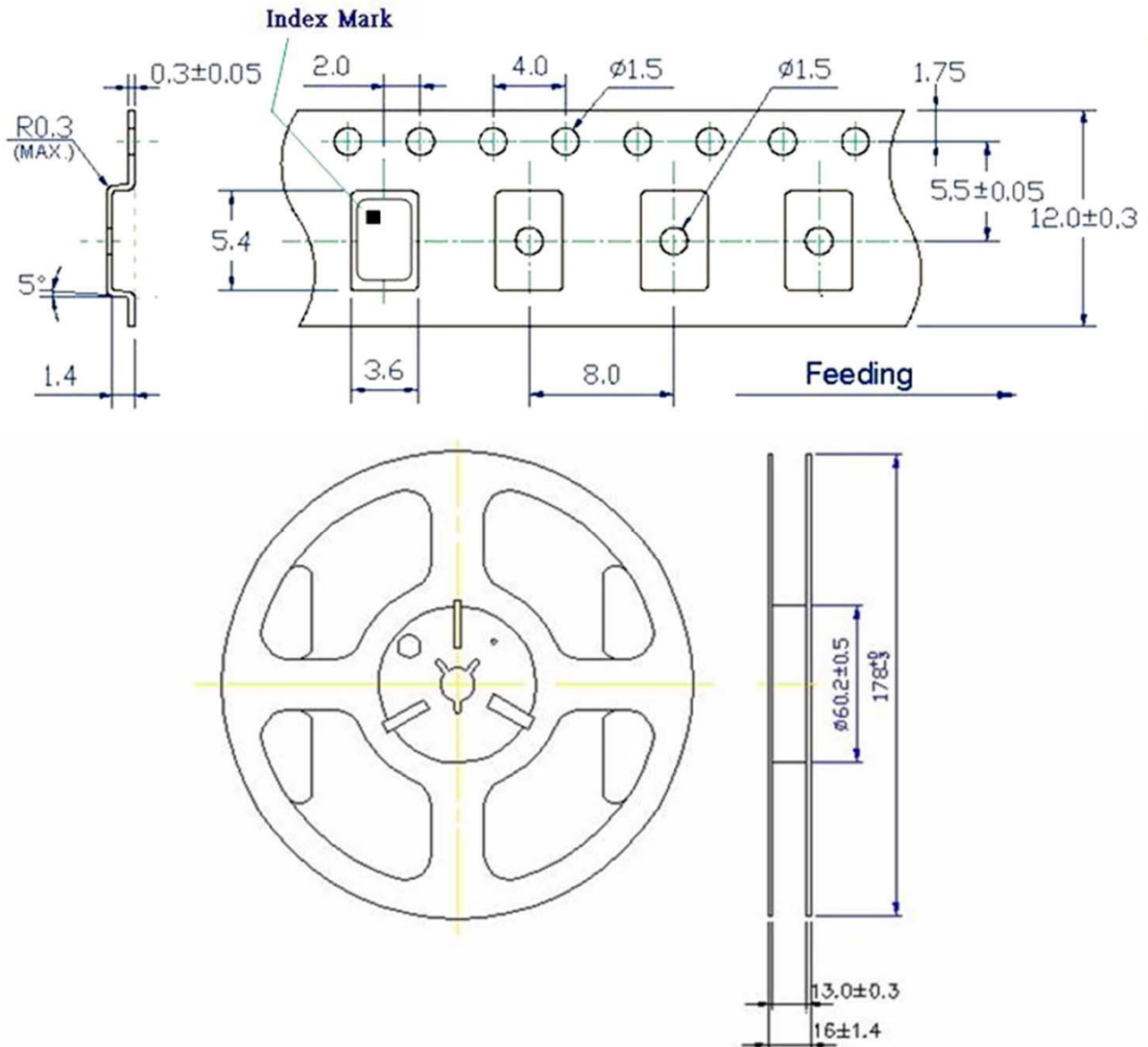

1. 230mm minimum leader which consist of carrier and/or tape followed by a minimum of 160mm of empty carrier tape sealed with cover tape.
2. 160mm minimum trailer of empty carrier tape sealed with cover tape.

TYPE SQ 5.0x3.2 SEAM SEALED CRYSTAL CLOCK OSCILLATOR

SQA000001Z

VER. C 26-Aug-18

PACKING

