

Xinger[®] IV

Ultra Small Low Profile 0603 Balun 50Ω to 50Ω Balanced

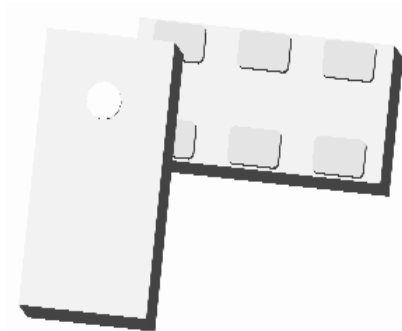

Description:

The X4BD40L1-5050G is an ultra-small low profile balanced to unbalanced transformer designed for differential inputs and output for 5G applications. The X4BD40L1-5050G is ideal for high volume manufacturing. The X4BD40L1-5050G is available on tape and reel for pick and place high volume manufacturing.

All of the Xinger components are constructed from ceramic filled PTFE composites, which possess excellent electrical and mechanical stability. All parts have been subjected to rigorous qualification testing and units are 100% RF tested. Produced in an ENIG final finish.

Features:

- 2300-6000 MHz
- 50 Ohm to 2 x 25 Ohm
- 5G Applications
- Very Low Loss
- Tight Amplitude Balance
- Input to Output DC Isolation
- Production Friendly
- Tape and Reel
- Non-conductive Surface
- RoHS Compliant
- Halogen Free

Electrical Specifications**

Frequency	Port Impedance	Insertion Loss	Return Loss	Amplitude Balance
MHz	Unbalanced : Balanced	dB Max	dB Min	dB Max
2300-2500	50:50	1.6	7.5	± 1.3
2500-5000	50:50	1.6	9	± 1.2
5000-6000	50:50	1.5	9	± 2.4
	Phase Balance	CMRR	Power	Operating Temp.
	Degrees	dB Min	Avg. CW Watts @105°C	°C
	180 ± 6	22	1	-55 to +140
	180 ± 7	23	1	-55 to +140
	180 ± 10	17	1	-55 to +140

**Specification based on performance of unit properly installed on Anaren Test Board with small signal applied. *Specifications subject to change without notice. Refer to parameter definitions for details.

Outline Drawing:

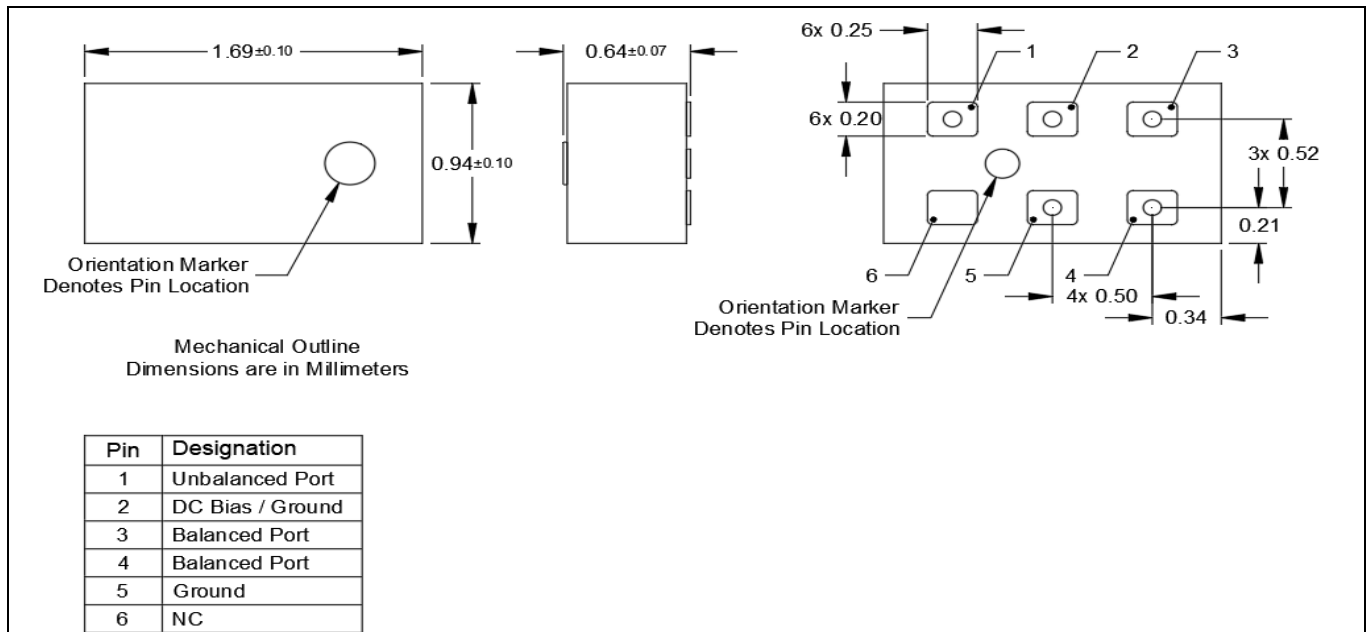

Insertion Loss and Power Derating Curves

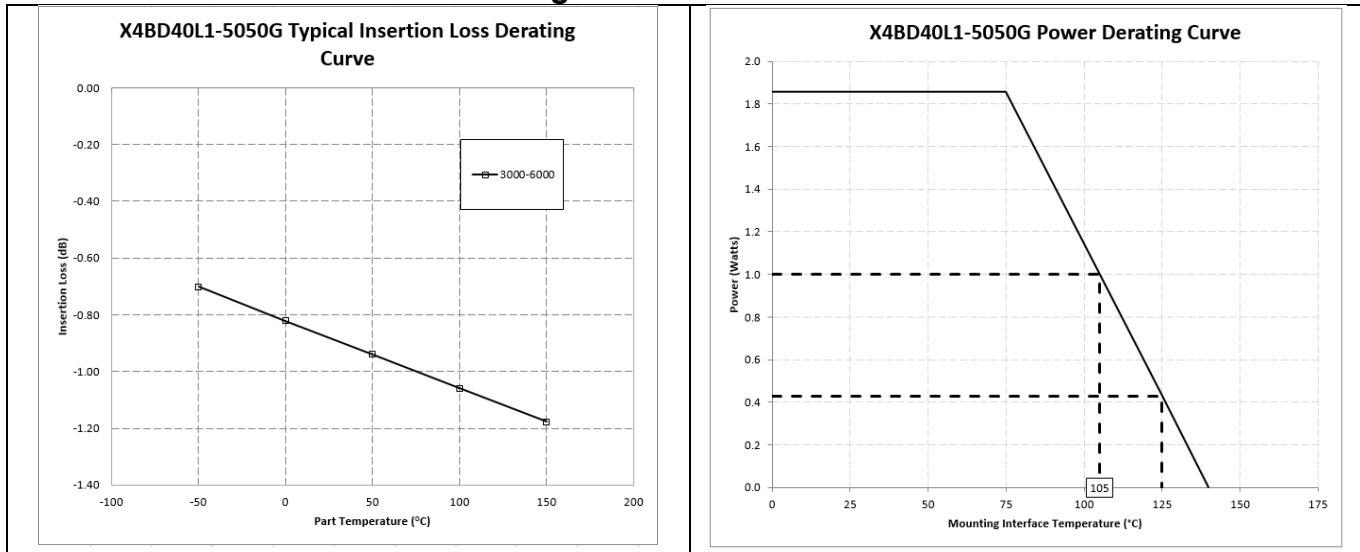

Insertion Loss Derating

The insertion loss, at a given frequency, of a group of components is measured at 25°C and then averaged. The measurements are performed under small signal conditions (i.e. using a Vector Network Analyzer). The process is repeated at 105°C and 140°C. A best-fit line for the measured data is computed and then plotted from -55°C to 140°C.

Power Derating

The power handling and corresponding power derating plots are a function of the thermal resistance, mounting surface temperature (base plate temperature), maximum continuous operating temperature of the component, and the thermal insertion loss. The thermal insertion loss is defined in the Power Handling section of the data sheet.

As the mounting interface temperature approaches the maximum continuous operating temperature, the power handling decreases to zero.

If mounting temperature is greater than 105°C, Xinger component will perform reliably as long as the input power is derated to the curve above.

Typical Performance: 3000 MHz to 8000 MHz

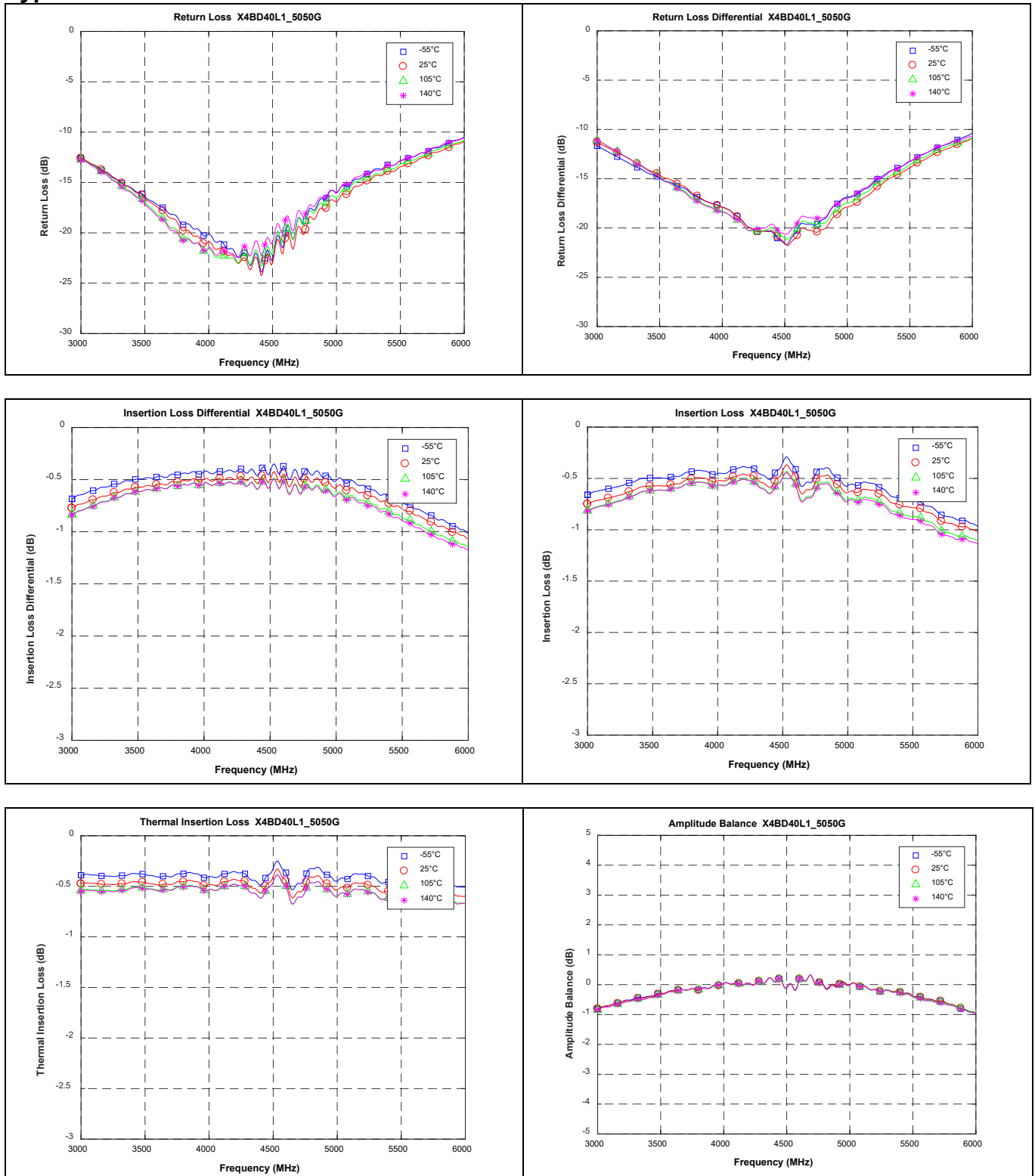

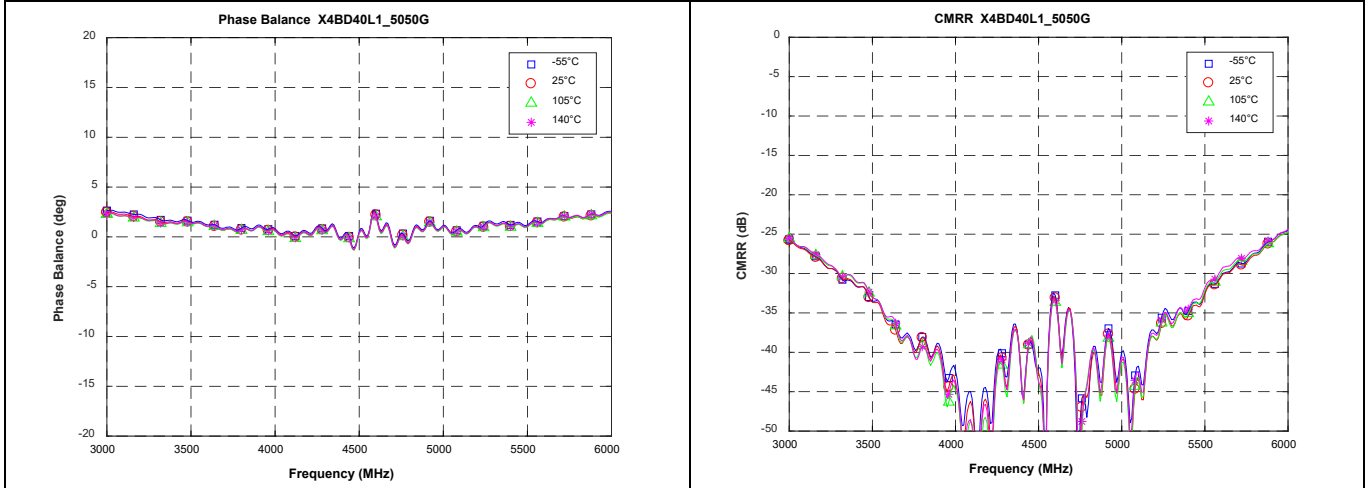

Definition of Measured Specifications

Parameter	Mathematical Representation
Return Loss, Single Ended	$RL = 20\log(S_{11})$
Return Loss, Differential	$S_{dd22} = RL_b = 20\log 1/2 (S_{22} - S_{23} - S_{32} + S_{33}) $
Insertion Loss, Total Power	$IL_p = 10\log(S_{21} ^2 + S_{31} ^2)$
Insertion Loss, Differential Power	$S_{sd21} = 20\log(\sqrt{1/2}(S_{21} - S_{31}))$
Phase Imbalance	$PB = \frac{180}{\pi} \arctan \frac{\text{Im}(S_{21}/S_{31})}{\text{Re}(S_{21}/S_{31})}$
Amplitude Imbalance	$AB = 20\log S_{21}/S_{31} $
Common Mode Rejection Ratio	$CMRR = \pm 20\log \frac{S_{21} + S_{31}}{S_{21} - S_{31}}$

*100% RF test is performed per spec definition.

Peak Power Handling

High-Pot testing of these components during the qualification procedure resulted in a minimum breakdown voltage of 1Kv (minimum recorded value). This voltage level corresponds to a breakdown resistance capable of handling at least 12dB peaks over average power levels, for very short durations. The breakdown location consistently occurred across the pads and the ground bar (see illustration below). The breakdown levels at these points will be affected by any contamination in the gap area around these pads. These areas must be kept clean for optimum performance. It is recommended that the user test for voltage breakdown under the maximum operating conditions and over worst case modulation induced power peaking. This evaluation should also include extreme environmental conditions (such as high humidity).

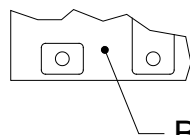

Breakdown Area

Mounting Configuration

In order for Xinger surface mount components to work optimally, the proper impedance transmission lines must be used to connect to the RF ports. If this condition is not satisfied, insertion loss, Isolation and VSWR may not meet published specifications.

All of the Xinger components are constructed from organic PTFE based composites which possess excellent electrical and mechanical stability. Xinger components are compliant to a variety of ROHS and Green standards and ready for Pb-free soldering processes. Pads are Gold plated with a Nickel barrier.

An example of the PCB footprint used in the testing of these parts is shown below. An example of a DC-biased footprint is also shown below. In specific designs, the transmission line widths need to be adjusted to the unique dielectric coefficients and thicknesses as well as varying pick and place equipment tolerances.

No Bias Footprint

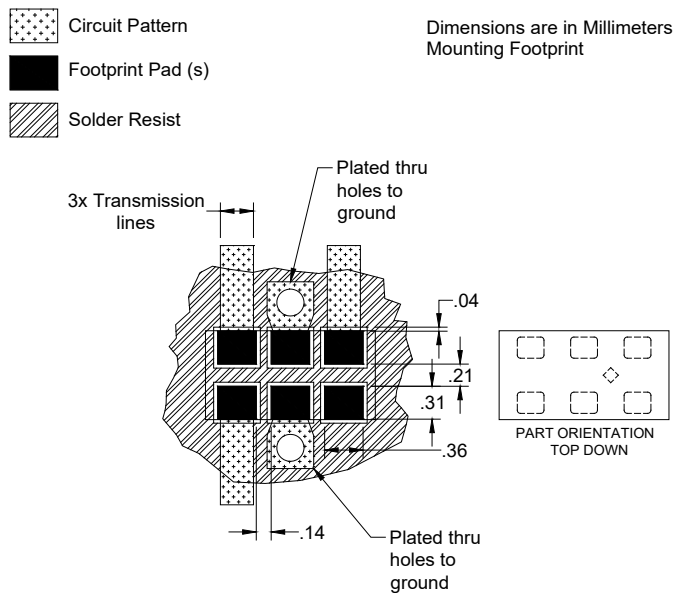

DC Bias Footprint

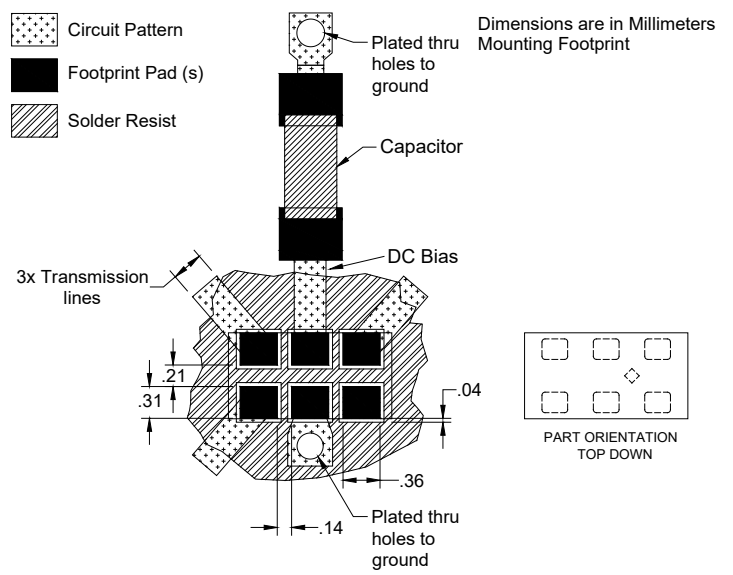

Packaging and Ordering Information:

Parts are available in reel and are packaged per EIA 481-D. Parts are oriented in tape and reel as shown below. Minimum order quantities are 4000 per reel.

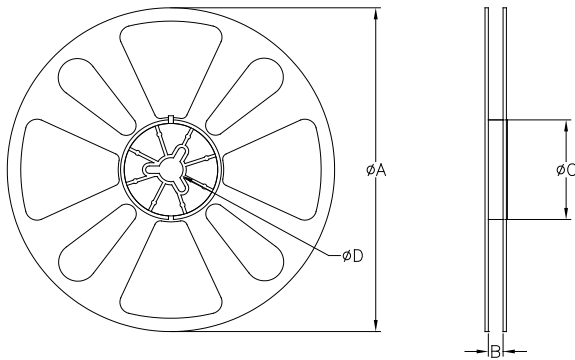
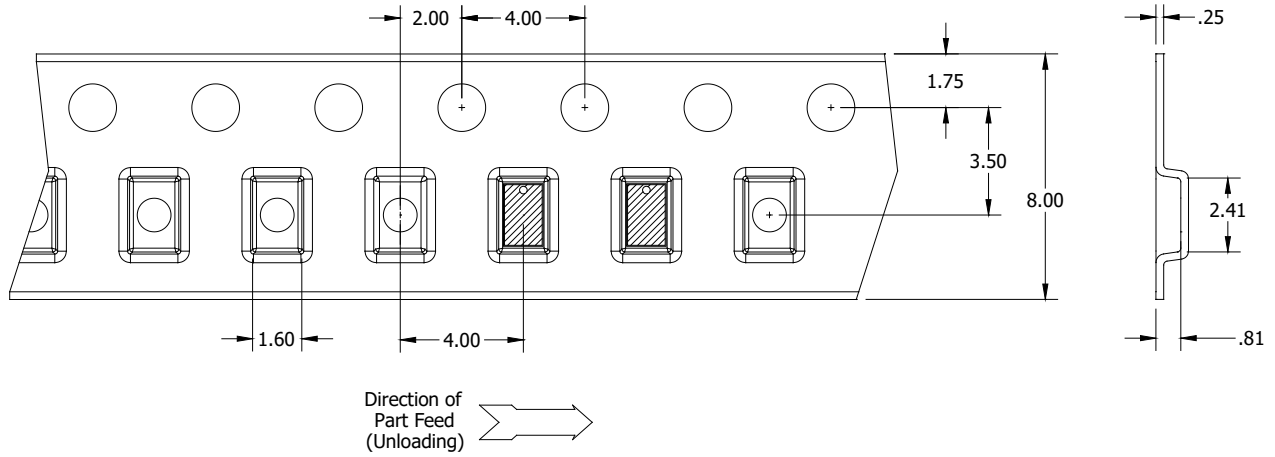

TABLE 1		
QUANTITY/REEL	REEL DIMENSIONS mm	
4000	φA	177.80
	B	8.00
	φC	50.80
	φD	13.00

Contact us:
rf&s_support@ttm.com