

**Applications**

- Portable electronic devices.
- 3C products.
- Smart phones.
- Digital cameras.

**LPT Series – Low-Profile Tactile Switches**

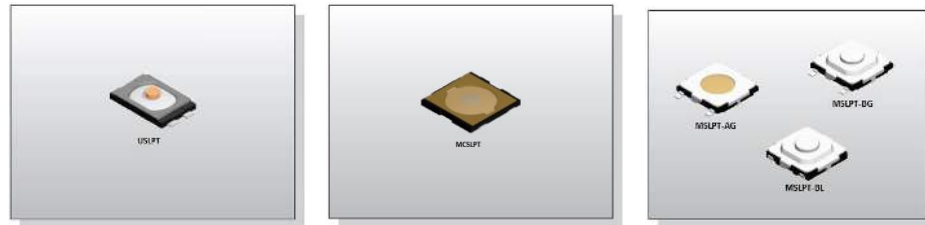

**Features**

- Compact size.
- Low-profile.
- Long operation life.
- Grounded options available.

TE Connectivity is pleased to introduce its LPT Series of Low-Profile Tactile Switches. Given the various combinations of Size and Height measures offered by the LPT Series, these tactile switches are ideal for a wide variety of applications within the portable electronics market.

The Low-Profile Tactile Switches will be characterised by SMT mounting available in Tab, Gull-Winged, and J-Bend terminations.

**LPT Series – Family Classification**

Family	USLPT (Ultra-Mini Size)	MCLPT (Micro-Mini Size)	MSLPT (Mini Size)
Body Size	2.6x1.6mm to 3.7x3.7mm	4.6x4.4mm to 4.8x4.8mm	5.2x5.2mm
Height	0.35mm to 0.65mm	0.55mm to 1.05mm	0.80mm to 2.00mm
Mounting	Tab / J-Bend	J-Bend	Gull-Wing / J-Bend
Grounding	No	No	Yes
Packaging	Tape & Reel	Tape & Reel	Tape & Reel

### USLPT Family – 3.0 x 2.6mm

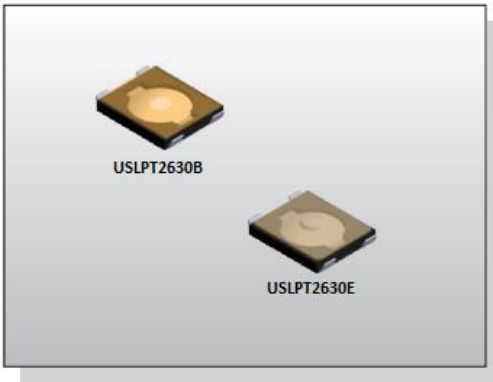
	Contact Rating	50mA, 12VDC
	Contact Resistance	500mΩ Max.
	Insulation Resistance	50MΩ Min. 500VDC
	Dielectric Strength	250VAC/1 Minute
	Operating Force	100±50gf (-1) 160±50gf (-2)
	Travel	0.15mm
	Operating Life	100,000 Cycles Min.
	Operating Temperature	-40°C to +85°C
	Storage Temperature	-20°C to +60°C (Within tape package)

Features	Applications
<ul style="list-style-type: none"> <li>• Compact size.</li> <li>• Extended operating life.</li> <li>• Ultra-low profile.</li> </ul>	<ul style="list-style-type: none"> <li>• Digital cameras.</li> <li>• Smart Phones.</li> <li>• Portable electronic devices.</li> </ul>

### Circuit

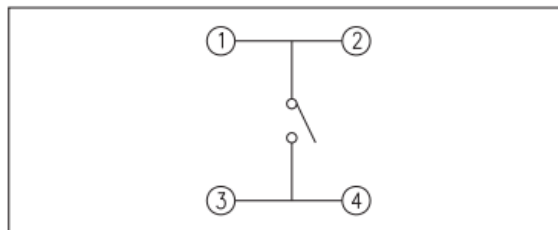

### Part Numbering

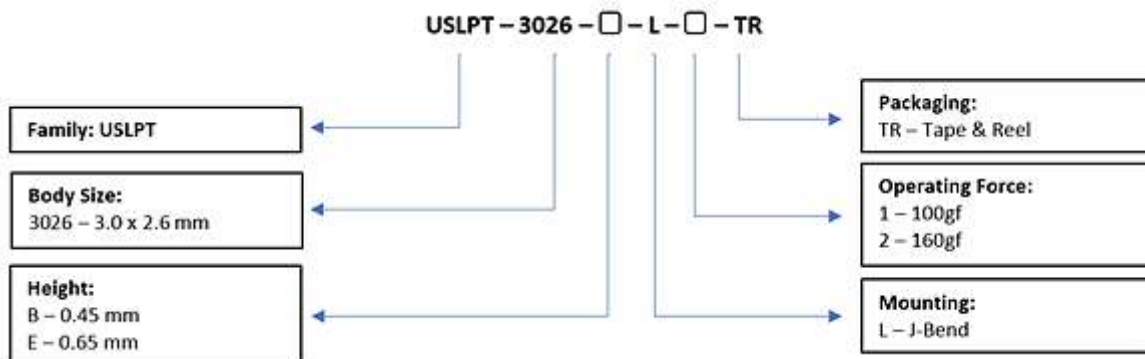

## Diagrams

### -USLPT2630B

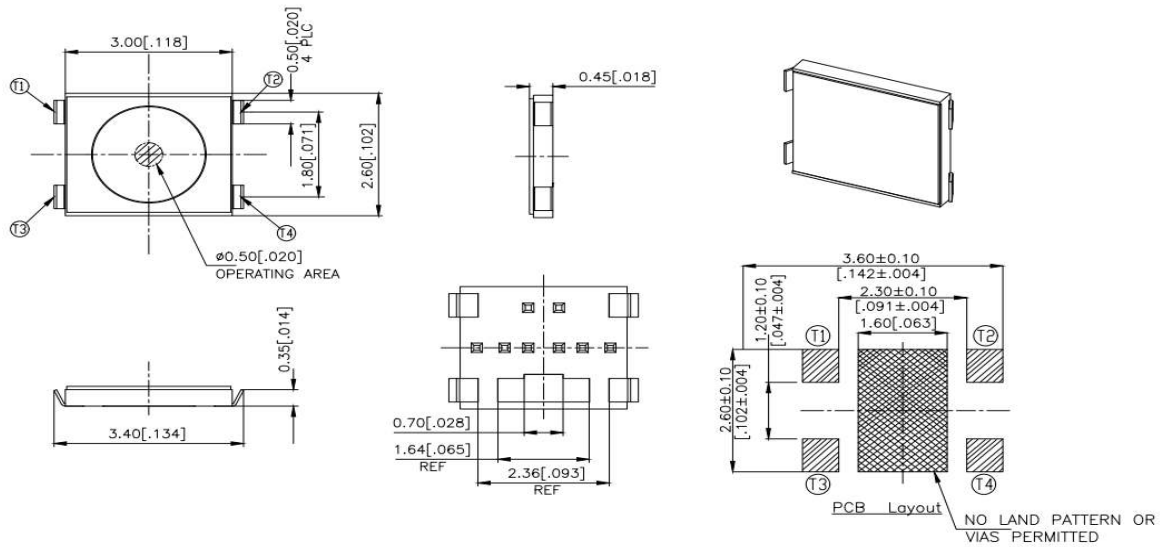

### -USLPT2630E

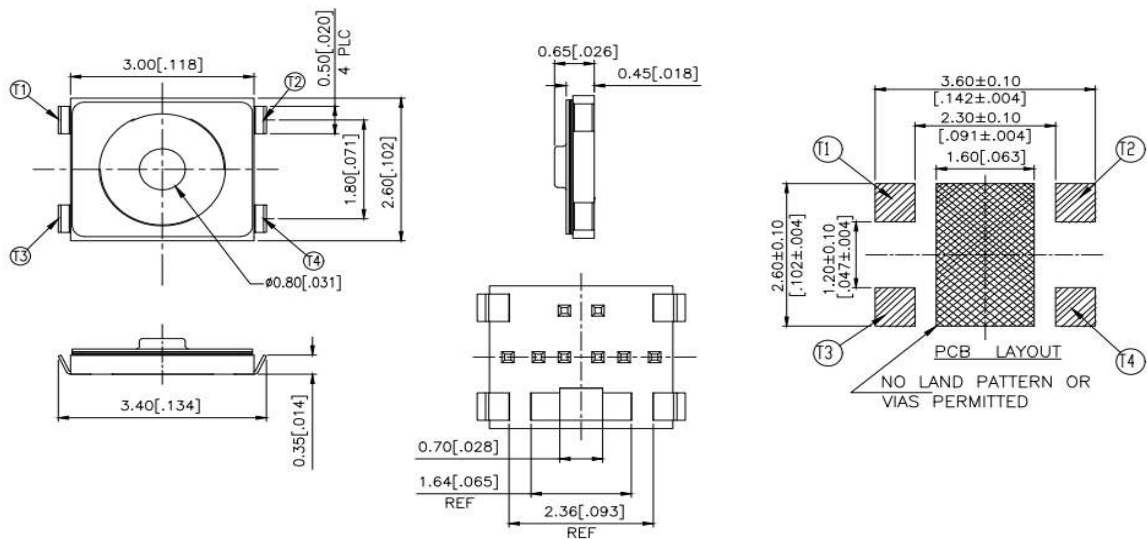

## PN List

Smart PN	Body Size	Height	Mounting	Operation Force	Packaging	MOQ	TE PN
USLPT3026BL1TR	3.0 x 2.6mm	0.45mm	J-Bend	100gf	Tape and Reel	2,500	2337227-1
USLPT3026BL2TR	3.0 x 2.6mm	0.45mm	J-Bend	160gf	Tape and Reel	2,500	2337227-2
USLPT3026EL1TR	3.0 x 2.6mm	0.65mm	J-Bend	100gf	Tape and Reel	2,500	2337228-1
USLPT3026EL2TR	3.0 x 2.6mm	0.65mm	J-Bend	160gf	Tape and Reel	2,500	2337228-2

**1. Style**

“Tactile Switches” are mainly used as signal switches of electric devices, with the general requirements of mechanical and electrical characteristic.

1.1 Operating Temperature Range: -40 °C to +85°C

1.2 Storage Temperature Range (In Packaging): -20 °C to +60°C

**2. Current Range:** 50mA, 12VDC Max.

**3. Type of Actuation:** Tactile feedback

**4. Test Sequence:**

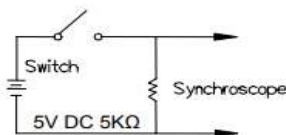
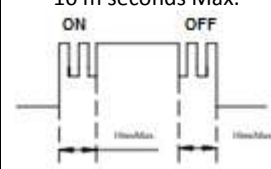
	Item	Description	Test Conditions	Requirements
Appearance	1	Visual Examination	By visual examination check without any out pressure & testing.	There shall be no defects that affect the serviceability of the product.
Electrical Performance	2	Contact Resistance	Applying a static load (1.5 to 2x actuating force) to the centre of the actuator. Measurements shall be made with a 1 kHz small current contact resistance meter.	500mΩ Max.
	3	Insulation Resistance	Measurements shall be made following application of 500VDC potential across terminals and cover for 1 minute± 5 seconds.	50MΩ Min.
	4	Dielectric Withstanding Voltage	250VAC (50Hz or 60Hz) shall be applied across terminals and cover for 1 minute.	There shall be no breakdown or flashover.
	5	Bounce	3 to 4 operations at a rate of 1 cycles per second 	10 m seconds Max. 



Mechanical Performance	6	Operating Force	Applied in the direction of operation.	100g±50gf (0.98±.49N)	160±50gf (1.569±0.49N)
	7	Stroke	Placing the switch such that the direction of switch operation is vertical and then gradually increasing the load applied to the centre of the actuator to a stop shall be measured.	0.15±0.1mm	
	8	Control strength	Static load of 5Kgf (49N) shall be applied in the operating direction of the control unit for 15 seconds.	As shown in items 2 to 6.	
	9	Solder Heat Resistance	(PCB is 1.2mm in thickness)	1) Shall be free from pronounced backlash and falling-off or breakage Terminals. 2) As shown in item 2 to 5.	
	10	Vibration	Shall be vibrated in accordance with Method 201A of MIL-STD-202F 1) Frequency: 10-55-10 Hz 1minute/cycle. 2) Direction: 3 vertical directions including the direction of operation. 3) Test Time: 2 hours each direction. 4) Swing distance: 1.5mm	As shown in item 2 to 6.	
	11	Shock	Shall be shocked in accordance with Method 213B condition A of MIL-STD-202F 1) Acceleration: 50G. 2) Action Time: 11 ± 1 m sec. 3) Testing Direction: 6 sides. 4) Test cycle: 3 times in each direction.	As shown in item 2 to 6.	
Durability	12	Operating Life	Measurements shall be made following the test forth below: 1) 5mA, 5VDC resistive load. 2) Applying a static load the operating force to the centre of the actuator in the direction of operation. 2) Cycle of Operation= ■ 100,000 Cycles Min.	1) As shown in item 4 to 5. 2) Operating force: ±50% of initial force. 3) Contact Resistance: 20Ω Max. 4) Insulation Resistance: 10MΩ Min. 5) Bounce: 20m seconds Max.	

Environmental Endurance	13	Withstand H <sub>2</sub> S	Following the test set forth below the sample shall be left in normal temperature and humidity conditions for 1 hour before the measurements are made: 1) Density : 3±1ppm 2) Temperature : 40±2°C 3) Relative Humidity : 80 to 85% 4) Time : 24 hours	Contact Resistance: 1Ω Max.
	14	Low Temperature Resistance	Following the test set forth below the sample shall be left in normal temperature and humidity conditions for 1 hour before the measurements are made: 1) Temperature: -40±2°C 2) Time: 500 hours	As shown in item 2 to 6.
	15	High Temperature Resistance	Following the test set forth below the sample shall be left in normal temperature and humidity conditions for 1 hour before the measurements are made: 1) Temperature: 85±2°C 2) Time: 500 hours	As shown in item 2 to 6.
	16	Humidity Resistance	Following the test set forth below the sample shall be left in normal temperature and humidity conditions for 1 hour before the measurements are made: 1) Temperature: 60±2°C 2) Relative Humidity: 90 to 95% 3) Time: 500 hours	As shown in item 2 to 6.

**5. Soldering Conditions:**

- Condition for Soldering USLPT Series:

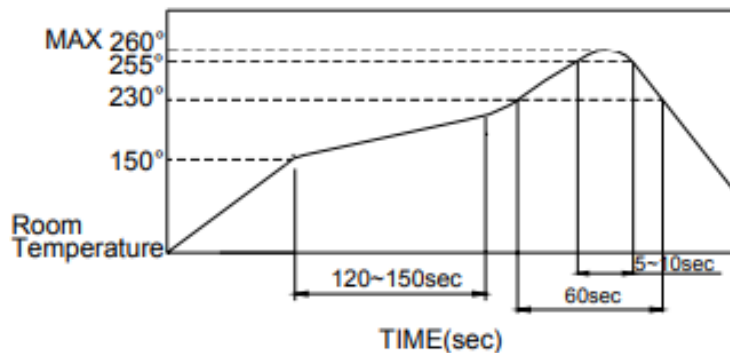

- The condition noted above is the temperature of the copper foil on the surface of the PCB. There are cases where the temperature of the board greatly differs from the surface of the switch. Do not allow the surface temperature of the switch to exceed 260°C.

### ■ Manual Soldering

Soldering Temperature: 350°C Max.

Continuous Soldering Time: 5 second Max.

### ■ Precautions in Handling

1. Care should be exercised so that flux from the top surface of the printed circuit board does not adhere to the switch.
2. Do not wash the switch.

### ■ Operating precautions

1. Do not actuate the switch with excessive force.
2. Discontinue force after the switch has been actuated so as to avoid deformation of the components of the switch. Deformation of the components may cause the switch to malfunction.
3. Align the plunger with the switch to insure proper operation.

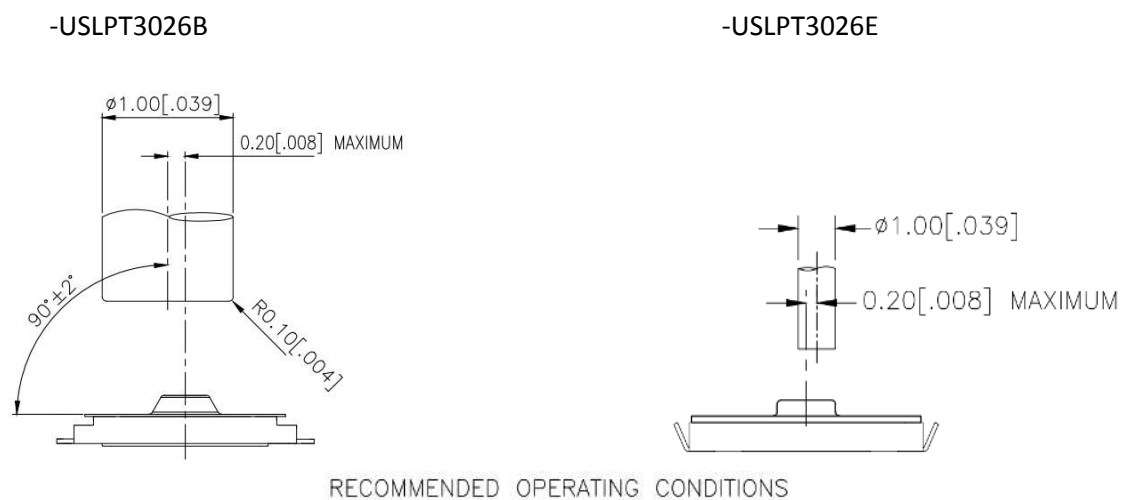

### ■ Notes on storage conditions

Avoid the following as exposure may affect the performance and/or the soldering of the switch:

1. Temperature of -10 to +40°C & 85% humidity.
2. Exposure to corrosive gas.
3. Storage over 6 months
4. Exposure to direct sunlight.
5. Storage conditions should prevent heavy impact or loading.
6. After opening the package, unused switches must be repackaged in a moisture-proof and airtight environment.