



### SPECIFICATIONS

Model	Max Torque	Reverse Torque	Damping Direction
FYT-D2-104	10Nm (100kgfcm)	—	Both directions

Max Angle	Operating Temperature	Weight	Body and Cap Material	Rotor (Shaft) Material	Oil Type
105°	-5 ~ 50°C	210±10g	Zinc die-cast (ZDC)	S25C	Silicone Oil

Note) Measured at 23°C±2°C The FYT/N-D2 series has a shorter shaft length

### DAMPING CHARACTERISTICS

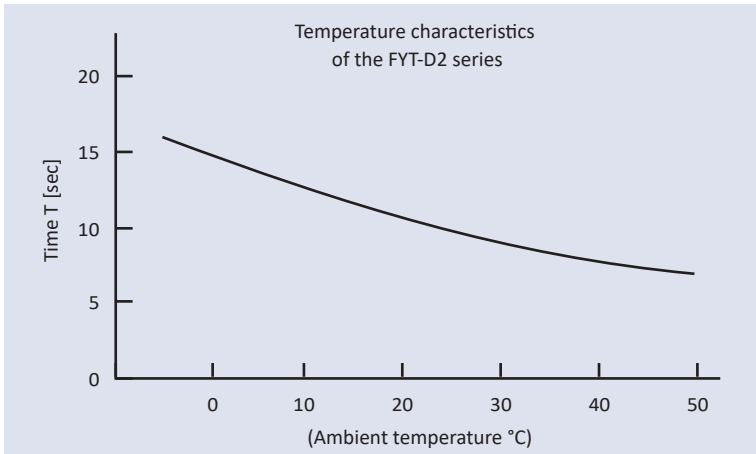

■ Damper characteristics vary according to the ambient temperature. In general, the damper characteristics become weaker as the temperature increases, and become stronger as the temperature decreases. This is because the viscosity of the oil inside the damper varies according to the temperature. When the temperature returns to normal, the damper characteristics will return to normal as well. The changes in the time it takes for the lid to close are shown in the graph to the left.

### OPTIONAL PART

#### Rotating Shaft Flange ROP-010H1

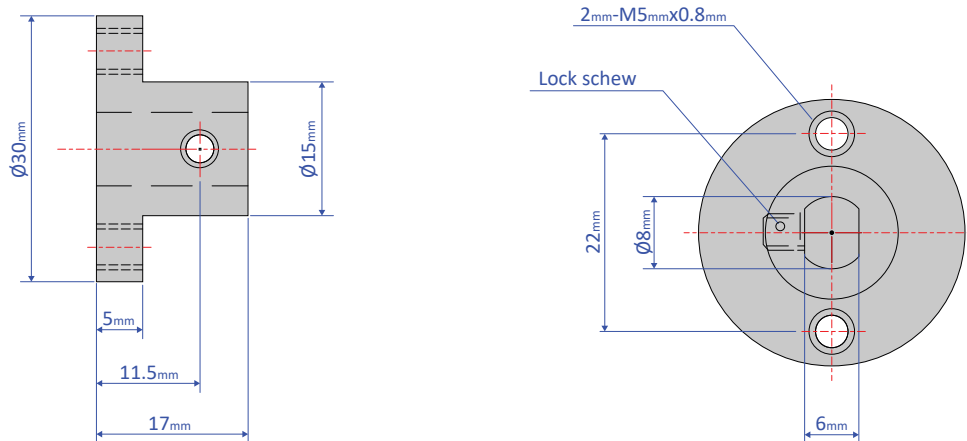

## HOW TO USE THE DAMPER

■ The uni-directional FYN-D2 is designed to generate a large torque just before a lid closing from a vertical position, as shown in Diagram A, comes to a full closure. When a lid is closed from a horizontal position, as shown in Diagram B, a strong torque is generated just before the lid is fully closed, causing the lid to not close properly. Torque is generated in both clockwise and counterclockwise directions in the FYN-D2 series. Unlike the FYN-D2 series, it does not have a fixed orifice for adjusting torque. Therefore, torque remains constant at any angle.

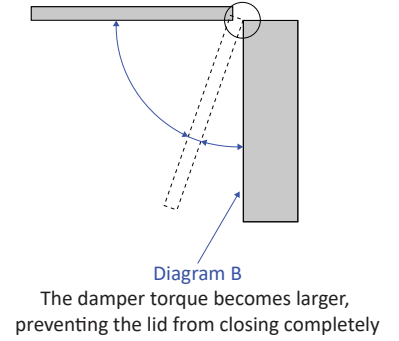
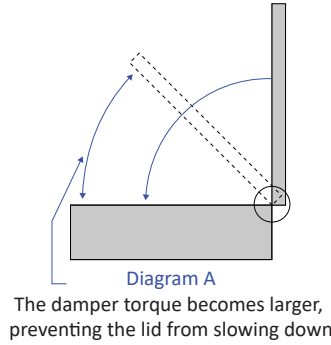

The angle in which the damper torque becomes large can be customized by modifying the inside orifice

■ When using a damper on a lid, such as the one shown in the diagram, use the following selection calculation to determine the damper torque.

Example)

Lid mass  $M$  : 5kg

Lid dimensions  $L$  : 0.4m

Gravity Center Position : Assumed as  $\frac{L}{2}$

Load torque :  $T = 5 \times 9.8 \times 0.4 \div 2$   
 $= 9.8 \text{ N} \cdot \text{m}$

Based on the above calculation, FYN-D1-\*104 is selected.

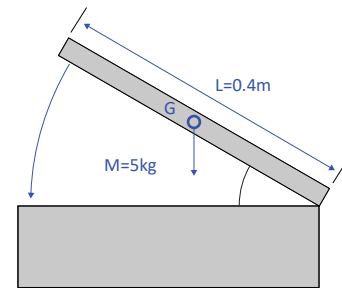

■ When connecting the rotating shaft to other parts, please ensure a tight fit between them. Without a tight fit, the lid will not slow down properly when closing. The corresponding dimensions for fixing the rotating shaft and the main body are as follows.

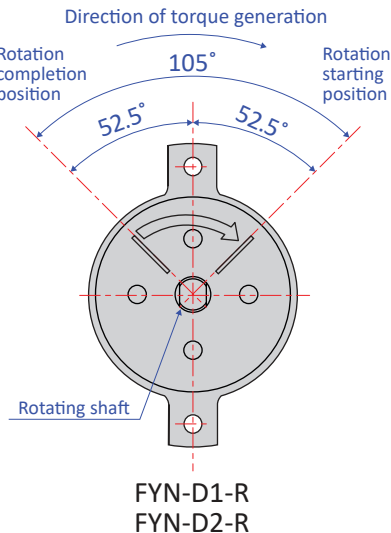
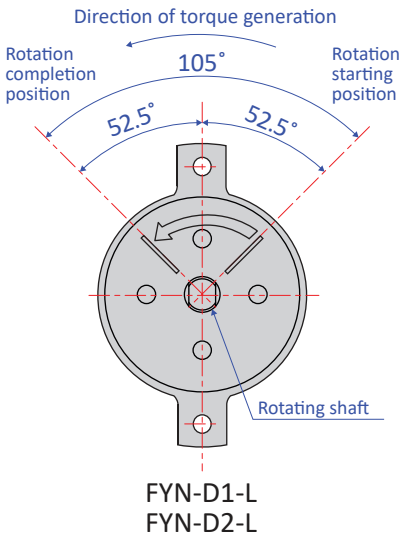
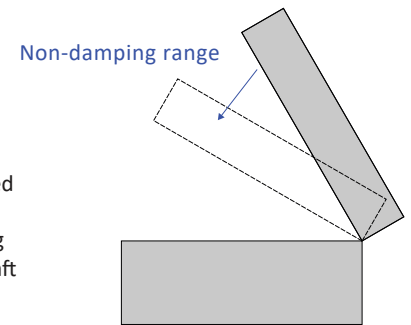
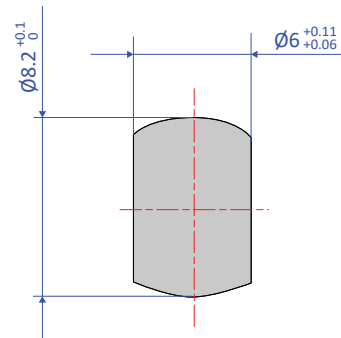

■ The damper's working angle is 105° with respect to the attachment flange, as shown to the left. Please determine where to attach it according to your needs. Also, rotating the damper beyond this angle will cause damage to the damper. Please ensure that an external stopper is in place.

■ The FYN-D1 series is a fixed type; its torque is non-adjustable. However, a customized order for a torque between the range of 2~20N·m is possible by changing the oil viscosity.

■ The direction in which torque is generated varies according to the model. Please select the appropriate model for your purpose.