

## N-channel 600 V, 0.255 $\Omega$ typ., 13 A MDmesh M2 Power MOSFET in a TO-220FP ultra narrow leads package

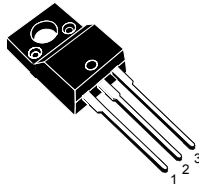

**TO-220FP**  
ultra narrow leads

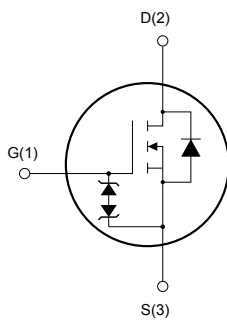

AM15572v1\_no\_tab



### Product status link

[STFU18N60M2](#)

### Product summary

<b>Order code</b>	STFU18N60M2
<b>Marking</b>	18N60M2
<b>Package</b>	TO-220FP ultra narrow leads
<b>Packing</b>	Tube

### Features

Order code	$V_{DS}$	$R_{DS(on)}$ max	$I_D$
STFU18N60M2	600 V	0.280 $\Omega$	13 A

- Extremely low gate charge
- Excellent output capacitance ( $C_{OSS}$ ) profile
- 100% avalanche tested
- Zener-protected

### Applications

- Switching applications
- LLC converters, resonant converters

### Description

This device is an N-channel Power MOSFET developed using MDmesh M2 technology. Thanks to its strip layout and an improved vertical structure, the device exhibits low on-resistance and optimized switching characteristics, rendering it suitable for the most demanding high efficiency converters.

# 1 Electrical ratings

**Table 1. Absolute maximum ratings**

Symbol	Parameter	Value	Unit
$V_{GS}$	Gate-source voltage	$\pm 25$	V
$I_D^{(1)}$	Drain current (continuous) at $T_C = 25\text{ }^\circ\text{C}$	13	A
	Drain current (continuous) at $T_C = 100\text{ }^\circ\text{C}$	8	A
$I_{DM}^{(2)}$	Drain current (pulsed)	52	A
$P_{TOT}$	Total power dissipation at $T_C = 25\text{ }^\circ\text{C}$	25	W
$dv/dt^{(3)}$	Peak diode recovery voltage slope	15	V/ns
$dv/dt^{(4)}$	MOSFET $dv/dt$ ruggedness	50	V/ns
$V_{ISO}$	Insulation withstand voltage (RMS) from all three leads to external heat sink ( $t = 1\text{ s}$ ; $T_C = 25\text{ }^\circ\text{C}$ )	2.5	kV
$T_{stg}$	Storage temperature range	-55 to 150	$^\circ\text{C}$
$T_j$	Operating junction temperature range		

- Limited by maximum junction temperature.
- Pulse width limited by safe operating area.
- $I_{SD} \leq 13\text{ A}$ ,  $di/dt \leq 400\text{ A}/\mu\text{s}$ ;  $V_{DS(peak)} < V_{(BR)DSS}$ ,  $V_{DD} = 400\text{ V}$
- $V_{DS} \leq 480\text{ V}$

**Table 2. Thermal data**

Symbol	Parameter	Value	Unit
$R_{thj-case}$	Thermal resistance junction-case	5	$^\circ\text{C}/\text{W}$
$R_{thj-amb}$	Thermal resistance junction-ambient	62.5	$^\circ\text{C}/\text{W}$

**Table 3. Avalanche characteristics**

Symbol	Parameter	Value	Unit
$I_{AR}$	Avalanche current, repetitive or not repetitive (pulse width limited by $T_{jmax}$ )	3	A
$E_{AS}$	Single pulse avalanche energy (starting $T_j = 25\text{ }^\circ\text{C}$ , $I_D = I_{AR}$ , $V_{DD} = 50\text{ V}$ )	135	mJ

## 2 Electrical characteristics

( $T_C = 25\text{ °C}$  unless otherwise specified).

**Table 4. On /off states**

Symbol	Parameter	Test conditions	Min.	Typ.	Max.	Unit
$V_{(BR)DSS}$	Drain-source breakdown voltage	$I_D = 1\text{ mA}$ , $V_{GS} = 0\text{ V}$	600			V
$I_{DSS}$	Zero gate voltage drain current	$V_{GS} = 0\text{ V}$ , $V_{DS} = 600\text{ V}$			1	$\mu\text{A}$
		$V_{GS} = 0\text{ V}$ , $V_{DS} = 600\text{ V}$ , $T_C = 125\text{ °C}$ <sup>(1)</sup>			100	$\mu\text{A}$
$I_{GSS}$	Gate-body leakage current	$V_{DS} = 0\text{ V}$ , $V_{GS} = \pm 25\text{ V}$			$\pm 10$	$\mu\text{A}$
$V_{GS(th)}$	Gate threshold voltage	$V_{DS} = V_{GS}$ , $I_D = 250\text{ }\mu\text{A}$	2	3	4	V
$R_{DS(on)}$	Static drain-source on-resistance	$V_{GS} = 10\text{ V}$ , $I_D = 6.5\text{ A}$		0.255	0.280	$\Omega$

1. Defined by design, not subject to production test.

**Table 5. Dynamic**

Symbol	Parameter	Test conditions	Min.	Typ.	Max.	Unit
$C_{iss}$	Input capacitance	$V_{DS} = 100\text{ V}$ , $f = 1\text{ MHz}$ , $V_{GS} = 0\text{ V}$	-	791	-	pF
$C_{oss}$	Output capacitance		-	40	-	pF
$C_{rSS}$	Reverse transfer capacitance		-	1.3	-	pF
$C_{oss\ eq.}$ <sup>(1)</sup>	Equivalent output capacitance	$V_{DS} = 0$ to $480\text{ V}$ , $V_{GS} = 0\text{ V}$	-	164.5	-	pF
$R_G$	Intrinsic gate resistance	$f = 1\text{ MHz}$ , $I_D = 0\text{ A}$	-	5.6	-	$\Omega$
$Q_g$	Total gate charge	$V_{DD} = 480\text{ V}$ , $I_D = 13\text{ A}$ , $V_{GS} = 0$ to $10\text{ V}$ (see Figure 14. Test circuit for gate charge behavior)	-	21.5	-	nC
$Q_{gs}$	Gate-source charge		-	3.2	-	nC
$Q_{gd}$	Gate-drain charge		-	11.3	-	nC

1.  $C_{oss\ eq.}$  is defined as a constant equivalent capacitance giving the same charging time as  $C_{oss}$  when  $V_{DS}$  increases from 0 to 80%  $V_{DSS}$ .

**Table 6. Switching times**

Symbol	Parameter	Test conditions	Min.	Typ.	Max.	Unit
$t_{d(on)}$	Turn-on delay time	$V_{DD} = 300\text{ V}$ , $I_D = 6.5\text{ A}$ , $R_G = 4.7\text{ }\Omega$ , $V_{GS} = 10\text{ V}$ (see Figure 13. Test circuit for resistive load switching times and Figure 18. Switching time waveform)	-	12	-	ns
$t_r$	Rise time		-	9	-	ns
$t_{d(off)}$	Turn-off delay time		-	47	-	ns
$t_f$	Fall time		-	10.6	-	ns

**Table 7. Source-drain diode**

Symbol	Parameter	Test conditions	Min.	Typ.	Max.	Unit
$I_{SD}$	Source-drain current		-		13	A
$I_{SDM}^{(1)}$	Source-drain current (pulsed)		-		52	A
$V_{SD}^{(2)}$	Forward on voltage	$I_{SD} = 13\text{ A}$ , $V_{GS} = 0\text{ V}$	-		1.6	V
$t_{rr}$	Reverse recovery time	$I_{SD} = 13\text{ A}$ , $di/dt = 100\text{ A}/\mu\text{s}$	-	305		ns
$Q_{rr}$	Reverse recovery charge	$V_{DD} = 60\text{ V}$ (see Figure 15. Test circuit for inductive load switching and diode recovery times)	-	3.3		$\mu\text{C}$
$I_{RRM}$	Reverse recovery current	(see Figure 15. Test circuit for inductive load switching and diode recovery times)	-	22		A
$t_{rr}$	Reverse recovery time	$I_{SD} = 13\text{ A}$ , $di/dt = 100\text{ A}/\mu\text{s}$	-	417		ns
$Q_{rr}$	Reverse recovery charge	$V_{DD} = 60\text{ V}$ , $T_j = 150\text{ }^\circ\text{C}$	-	4.6		$\mu\text{C}$
$I_{RRM}$	Reverse recovery current	(see Figure 15. Test circuit for inductive load switching and diode recovery times)	-	22		A

1. Pulse width limited by safe operating area.
2. Pulsed: pulse duration = 300  $\mu\text{s}$ , duty cycle 1.5%.

## 2.1 Electrical characteristics (curves)

Figure 1. Safe operating area

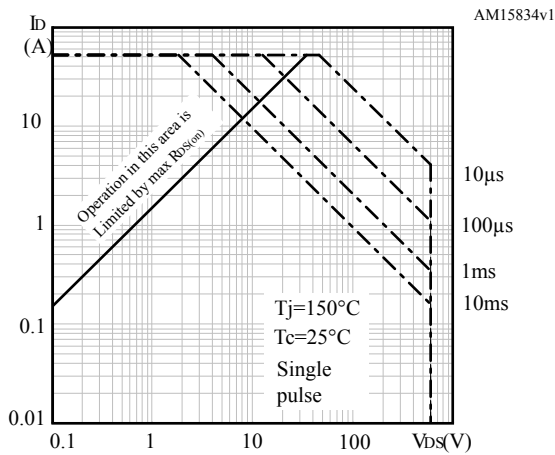

Figure 2. Thermal impedance

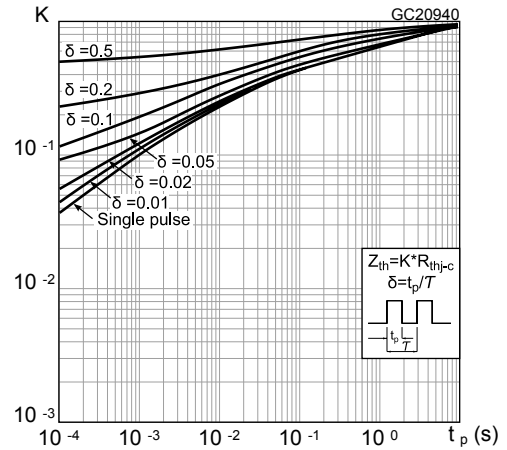

Figure 3. Output characteristics

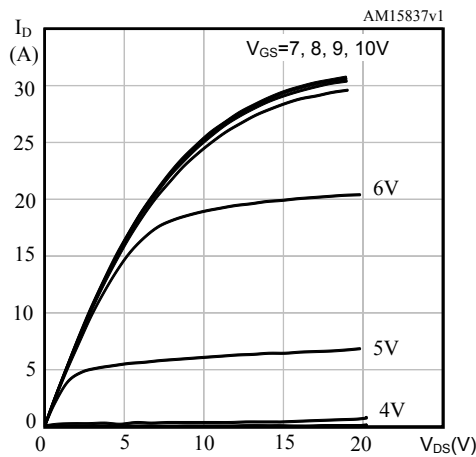

Figure 4. Transfer characteristics

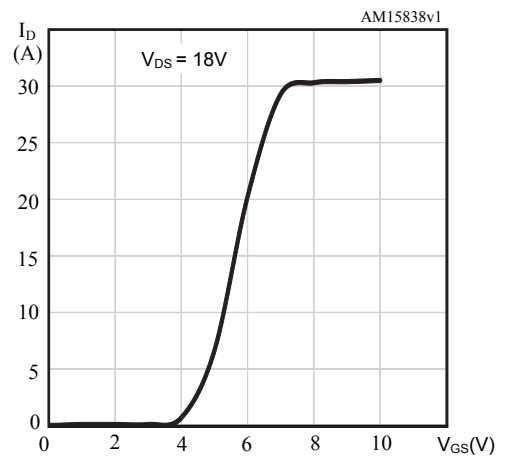

Figure 5. Gate charge vs gate-source voltage

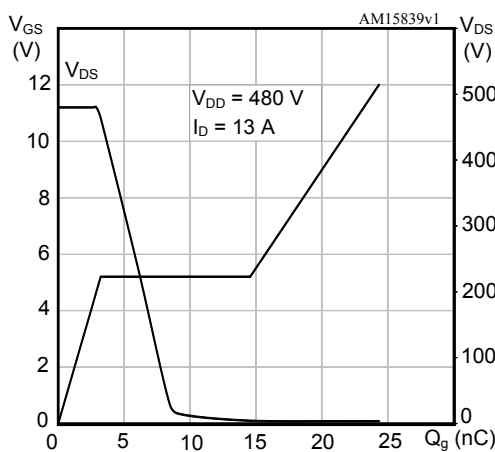
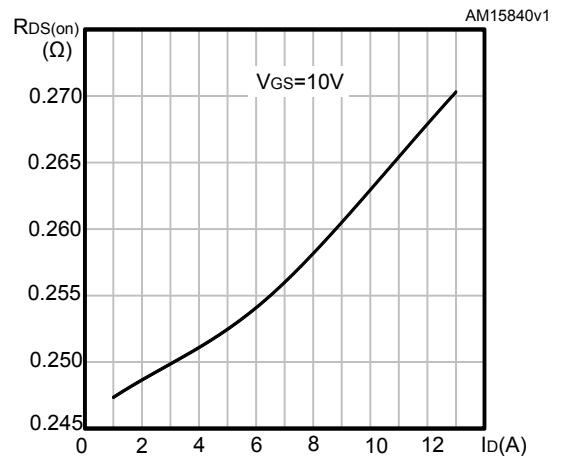
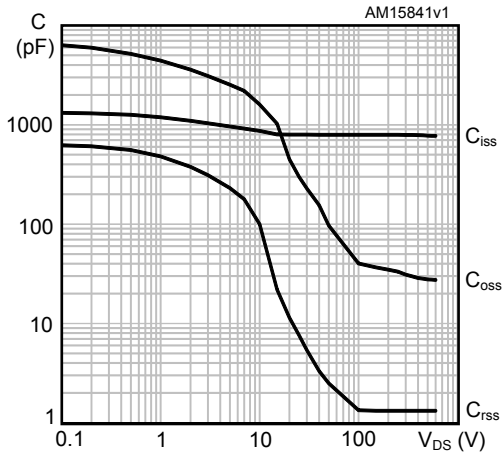

Figure 6. Static drain-source on-resistance



**Figure 7. Capacitance variations**



**Figure 8. Normalized gate threshold voltage vs. temperature**

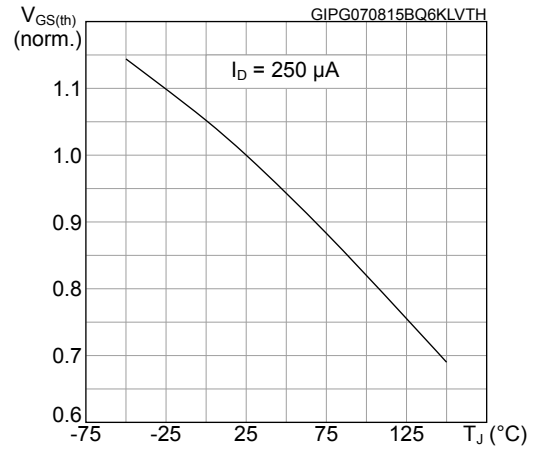

**Figure 9. Normalized on-resistance vs temperature**

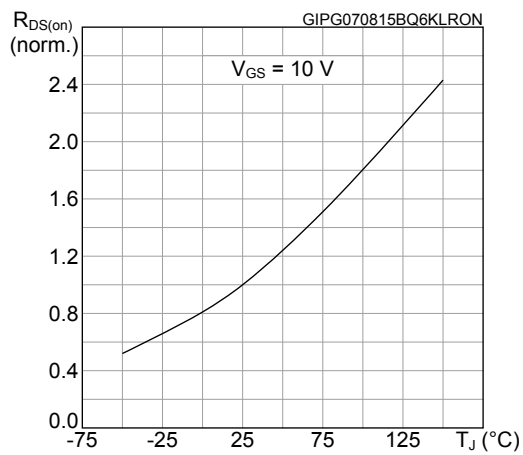

**Figure 10. Source-drain diode forward characteristics**

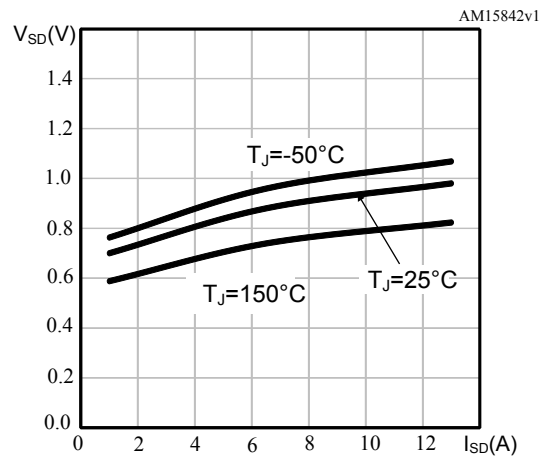

**Figure 11. Normalized  $V_{(BR)DSS}$  vs temperature**

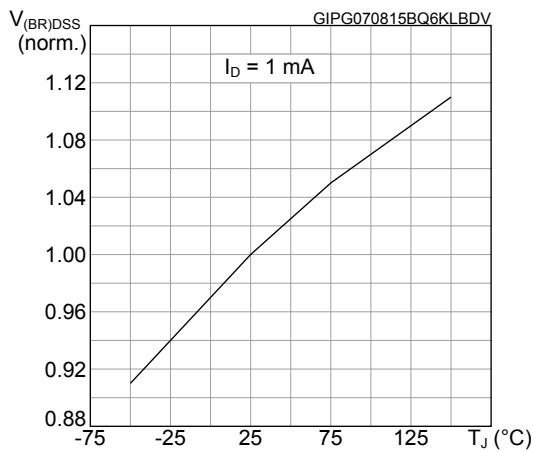

**Figure 12. Output capacitance stored energy**

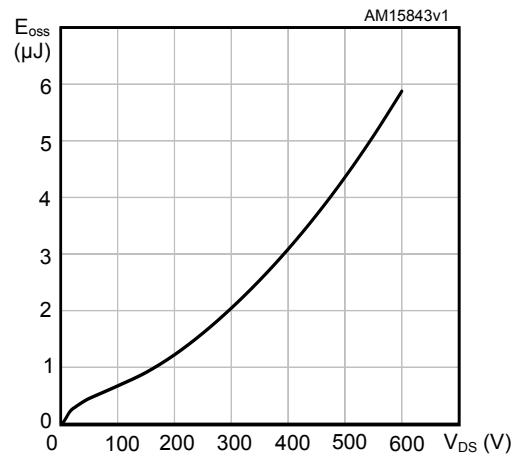

### 3 Test circuits

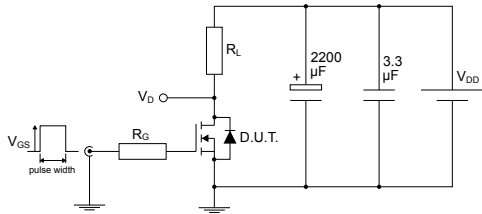
**Figure 13. Test circuit for resistive load switching times**

AM01468v1

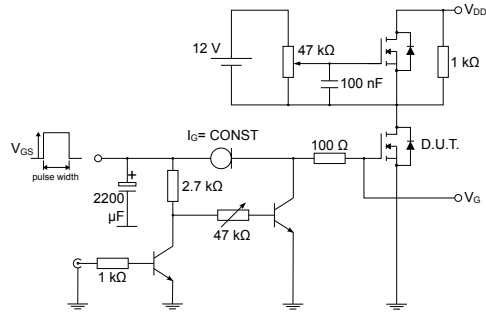
**Figure 14. Test circuit for gate charge behavior**

AM01469v1

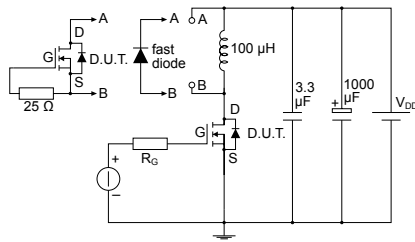
**Figure 15. Test circuit for inductive load switching and diode recovery times**

AM01470v1

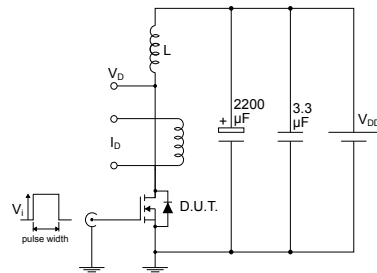
**Figure 16. Unclamped inductive load test circuit**

AM01471v1

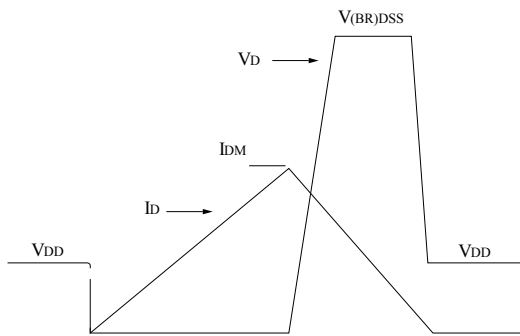
**Figure 17. Unclamped inductive waveform**

AM01472v1

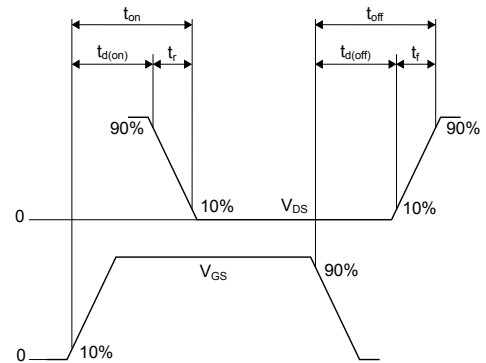
**Figure 18. Switching time waveform**

AM01473v1

## 4 Package information

In order to meet environmental requirements, ST offers these devices in different grades of **ECOPACK** packages, depending on their level of environmental compliance. ECOPACK specifications, grade definitions and product status are available at: [www.st.com](http://www.st.com). ECOPACK is an ST trademark.

### 4.1 TO-220FP ultra narrow leads package information

Figure 19. TO-220FP ultra narrow leads package outline

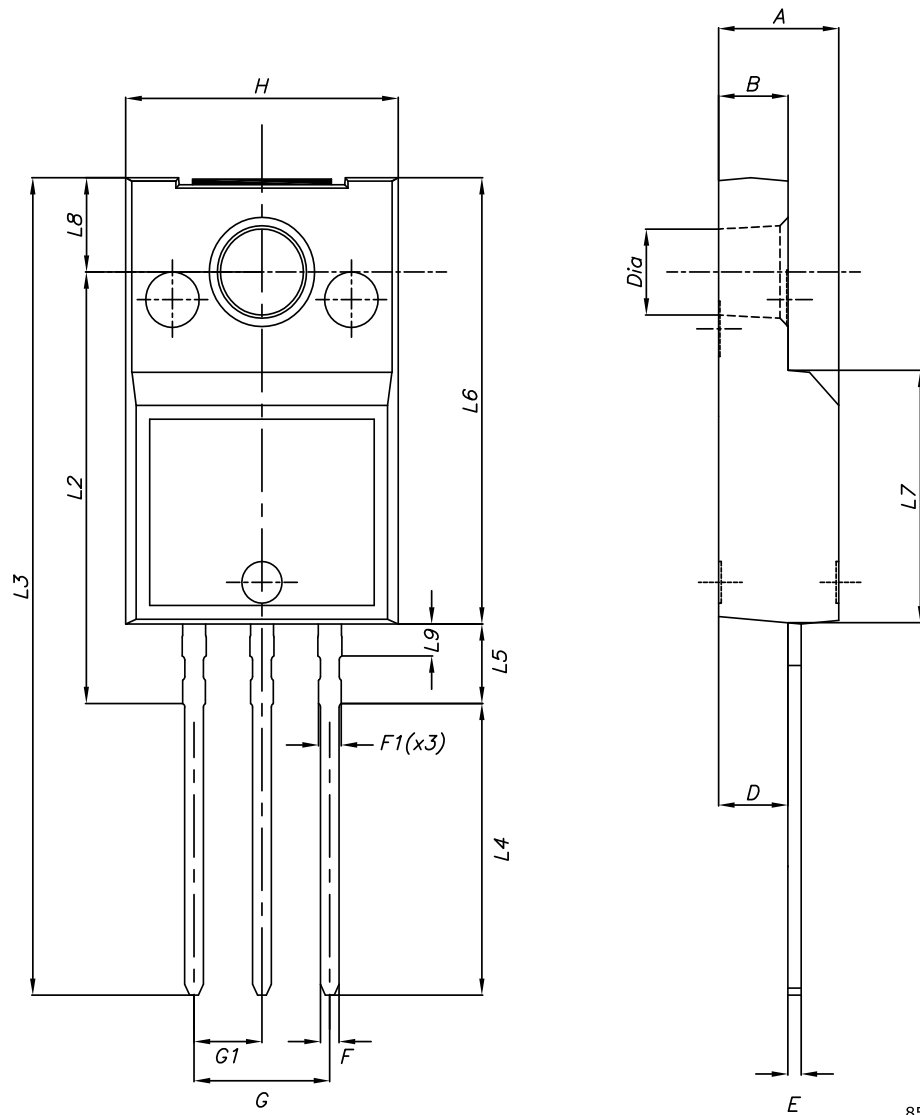

8576148\_2



**Table 8. TO-220FP ultra narrow leads mechanical data**

Dim.	mm		
	Min.	Typ.	Max.
A	4.40		4.60
B	2.50		2.70
D	2.50		2.75
E	0.45		0.60
F	0.65		0.75
F1	-		0.90
G	4.95		5.20
G1	2.40	2.54	2.70
H	10.00		10.40
L2	15.10		15.90
L3	28.50		30.50
L4	10.20		11.00
L5	2.50		3.10
L6	15.60		16.40
L7	9.00		9.30
L8	3.20		3.60
L9	-		1.30
Dia.	3.00		3.20

## Revision history

**Table 9. Document revision history**

Date	Revision	Changes
12-Mar-2015	1	Initial release.
15-Sep-2015	2	Document status promoted from preliminary to production data.
20-Jun-2019	3	<p>Updated <a href="#">Section Features</a>, <a href="#">Section 1 Electrical ratings</a>, <a href="#">Section 2 Electrical characteristics</a>, <a href="#">Section 2.1 Electrical characteristics (curves)</a> and <a href="#">Figure 19. TO-220FP ultra narrow leads package outline</a>.</p> <p>Minor text changes.</p>

---

## Contents

<b>1</b>	<b>Electrical ratings</b> .....	<b>2</b>
<b>2</b>	<b>Electrical characteristics</b> .....	<b>3</b>
<b>2.1</b>	<b>Electrical characteristics (curves)</b> .....	<b>5</b>
<b>3</b>	<b>Test circuits</b> .....	<b>7</b>
<b>4</b>	<b>Package information</b> .....	<b>8</b>
<b>4.1</b>	<b>TO-220FP ultra narrow leads package information</b> .....	<b>8</b>
	<b>Revision history</b> .....	<b>10</b>

**IMPORTANT NOTICE – PLEASE READ CAREFULLY**

STMicroelectronics NV and its subsidiaries (“ST”) reserve the right to make changes, corrections, enhancements, modifications, and improvements to ST products and/or to this document at any time without notice. Purchasers should obtain the latest relevant information on ST products before placing orders. ST products are sold pursuant to ST’s terms and conditions of sale in place at the time of order acknowledgement.

Purchasers are solely responsible for the choice, selection, and use of ST products and ST assumes no liability for application assistance or the design of Purchasers’ products.

No license, express or implied, to any intellectual property right is granted by ST herein.

Resale of ST products with provisions different from the information set forth herein shall void any warranty granted by ST for such product.

ST and the ST logo are trademarks of ST. For additional information about ST trademarks, please refer to [www.st.com/trademarks](http://www.st.com/trademarks). All other product or service names are the property of their respective owners.

Information in this document supersedes and replaces information previously supplied in any prior versions of this document.

© 2019 STMicroelectronics – All rights reserved