

Purpose

The RT7272A is a high-efficiency current mode synchronous step-down regulator that can deliver up to 3A output current from a wide input voltage range of 4.5V to 36V. This document explains the function and use of the RT7272A evaluation board (EVB) and provides information to enable operation and modification of the evaluation board and circuit to suit individual requirements.

Table of Contents

<i>Purpose</i>	1
<i>Introduction</i>	2
<i>General Product Information</i>	2
<i>Key Performance Summary Table</i>	2
<i>Bench Test Setup Conditions</i>	3
<i>Headers Description and Placement</i>	3
<i>Test Points</i>	3
<i>Power-up & Measurement Procedure</i>	4
<i>Output Voltage Setting</i>	4
<i>Schematic, Bill of Materials and Board Layout</i>	5
<i>EVB Schematic Diagram</i>	5
<i>Bill of Materials</i>	6
<i>EVB Layout</i>	7
<i>More Information</i>	11
<i>Important Notice for Richtek Evaluation Board</i>	11

Introduction

General Product Information

General Description

The RT7272A is a high efficiency, current mode synchronous step-down DC/DC converter that can deliver up to 3A output current over a wide input voltage range from 4.5V to 36V. The device integrates a 150mΩ high side and an 80mΩ low side MOSFET to achieve high conversion efficiency up to 95%. The current mode control architecture supports fast transient response and uses a simple compensation circuit.

A cycle-by-cycle current limit function provides protection against a shorted output and an internal soft-start eliminates input surge current during start-up. The RT7272A provides complete protection functions such as input under voltage lockout, output under voltage protection, over current protection and thermal shutdown.

The RT7272A is available in the thermal enhanced SOP-8 (Exposed Pad) package.

Features

- 4.5V to 36V Input Voltage Range
- 3A Output Current
- Internal N-MOSFETs
- Current Mode Control
- Fixed Frequency Operation : 500kHz
- Adjustable Output Voltage from 0.8V to 30V
- High Efficiency Up to 95%
- Stable with Low ESR Ceramic Output Capacitors
- Cycle-by-Cycle Current Limit
- Adjustable Current Limit

Key Performance Summary Table

Key features	Evaluation board number: PCB001_V1
Default Input Voltage	12V
Max Output Current	3A (OCP level set to 5.5A typical by $R_{LIM} = 137k\Omega$)
Default Output Voltage	3.3V
Default Marking & Package Type	RT7272AGSP, SOP-8 (Exposed Pad)
Operation Frequency	Steady 500kHz at all load currents
Other Key Features	4.5V to 36V Wide Input Voltage Range Adjustable Current Limit 2A to 6A
Protection	Over Current Protection & Output Under-Voltage-Protection (hiccup mode) Input Under-voltage Lock-out Thermal Shutdown

Bench Test Setup Conditions

Headers Description and Placement

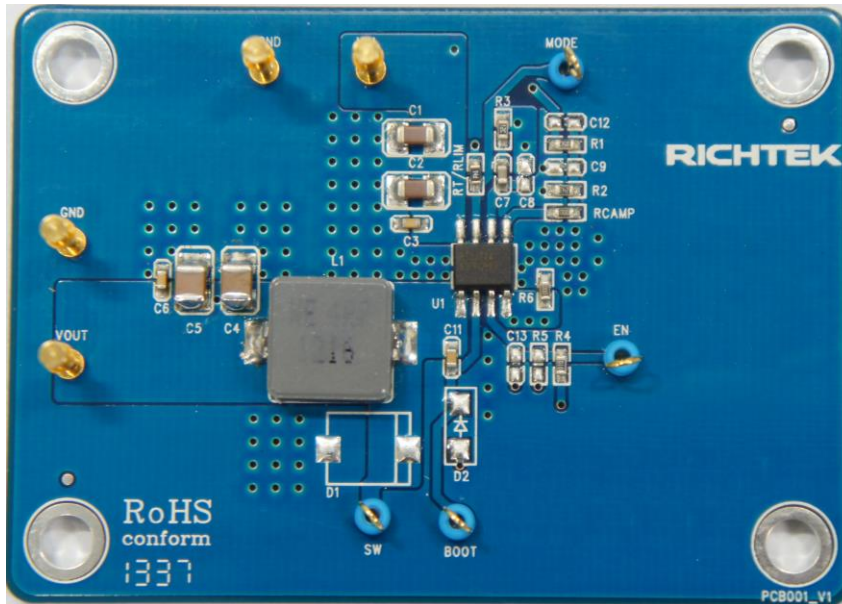

Please carefully inspect the EVB IC and external components, comparing them to the following Bill of Materials, to ensure that all components are installed and undamaged. If any components are missing or damaged during transportation, please contact the distributor or send e-mail to evb_service@richtek.com.

Test Points

The EVB is provided with the test points and pin names listed in the table below.

Test point/ Pin name	Signal	Comment (expected waveforms or voltage levels on test points)
VIN	Input voltage	Input voltage range= 4.5V to 36V
VOUT	Output voltage	Default output voltage = 3.3V Output voltage range= 0.8V to 30V (see " Output Voltage Setting" section for changing output voltage level)
SW	Switching node test point	SW waveform
EN	Enable test point	Enable signal. EN is automatically pulled high (by R4) to enable operation. Connect EN low to disable operation.
BOOT	Boot strap supply test point	Floating supply voltage for the high-side N-MOSFET switch
MODE	RLIM test point	Current limit setting point
GND	Ground	Ground

Power-up & Measurement Procedure

1. Apply a 12V nominal input power supply ($4.5V < V_{IN} < 36V$) to the VIN and GND terminals.
2. The EN voltage is pulled to logic high by R4 (100kΩ to VIN) to enable operation. Drive EN high (>2.0V) to enable operation or low (<0.4V) to disable operation.
3. Verify the output voltage (approximately 3.3V) between VOUT and GND.
4. Connect an external load up to 3A to the VOUT and GND terminals and verify the output voltage and current.

Output Voltage Setting

Set the output voltage with the resistive divider (R1, R2) between VOUT and GND with the midpoint connected to FB through RCAMP. The output is set by the following formula:

$$V_{OUT} = 0.8 \times \left(1 + \frac{R1}{R2}\right) \quad V_{OUT} = 0.8 \times \left(1 + \frac{R1}{R2}\right)$$

The installed V_{OUT} capacitors (C4, C5) are 22μF, 16V X5R ceramic types. Do not exceed their operating voltage range and consider their voltage coefficient (capacitance vs. bias voltage) and ensure that the capacitance is sufficient to maintain stability and provide sufficient transient response for your application. This can be verified by checking the output transient response as described in the RT7272A IC datasheet.

Schematic, Bill of Materials and Board Layout

EVB Schematic Diagram

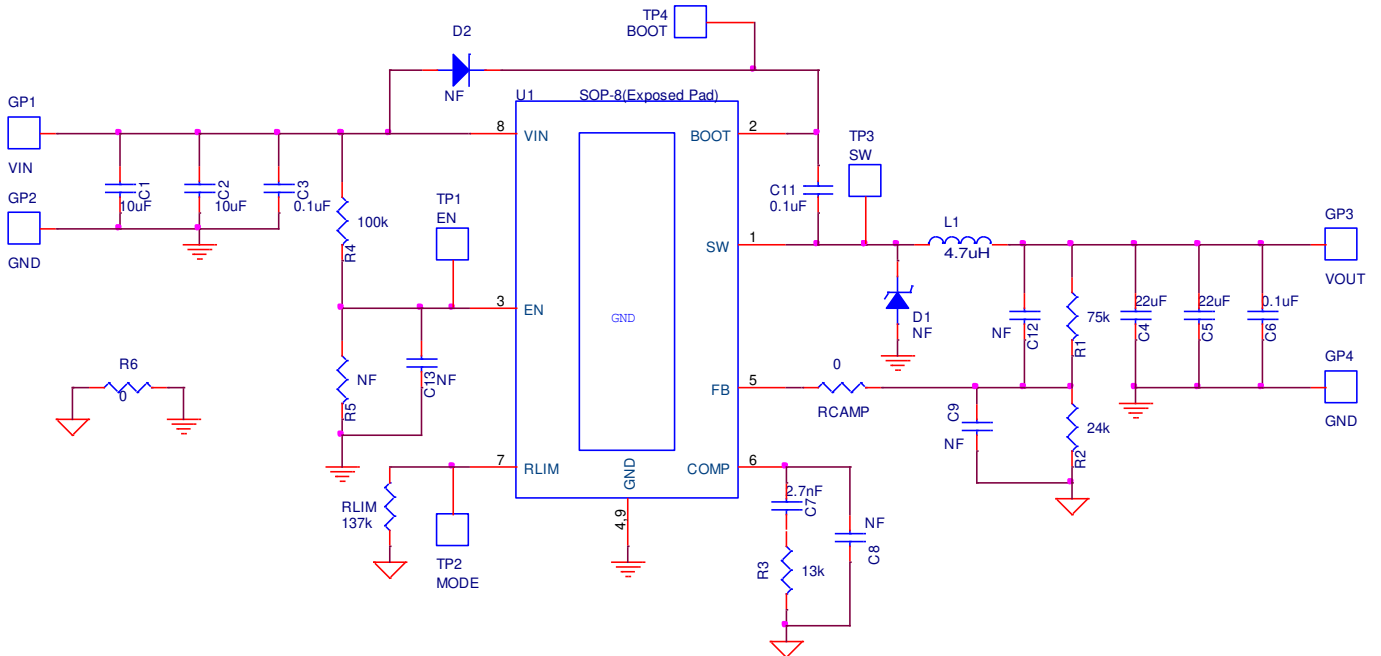

C1, C2: 10 μ F/50V/X5R, 1206, TDK C3216X5R1H106K

C4, C5: 22 μ F/16V/X5R, 1210, Murata GRM32ER61C226K

L1: 4.7 μ H WE74437368047, DCR=15m Ω

Bill of Materials

Reference	Qty	Part number	Description	Package	Manufacture
U1	1	RT7272AGSP	DC/DC Converter	PSOP-8	Richtek
C1, C2	2	C3216X5R1H106K160AB	10 μ F/ \pm 10%/50V/X5R Ceramic Capacitor	1206	TDK
C4, C5	2	GRM32ER61C226KE20#	22 μ F/ \pm 10%/16V/X5R Ceramic Capacitor	1210	Murata
C7	1	0603B272K500	2.7nF/ \pm 10%/50V/X7R Ceramic Capacitor	0603	WALSIN
C3, C6, C11	3	C1608X7R1H104K080AA	0.1 μ F/ \pm 10%/50V/X7R Ceramic Capacitor	0603	TDK
C8,C9,C12,C13	0		Not Installed	0603	
L1	1	WE74437368047	4.7 μ H/19A/ \pm 20%, DCR=15m Ω , Inductor	11mmx10mmx3.8mm	WE
R1	1		75k Ω / \pm 1%, Resistor	0603	
R2	1		24k Ω / \pm 1%, Resistor	0603	
R3	1		13k Ω / \pm 1%, Resistor	0603	
R4	1		100k Ω / \pm 1%, Resistor	0603	
R5, D1, D2	0		Not Installed		
R6, RCAMP	2		0 Ω , Resistor	0603	
RLIM	1		137k Ω / \pm 1%, Resistor	0603	
TP	4		Test Pin		
GP	4		Golden Pin		

EVB Layout

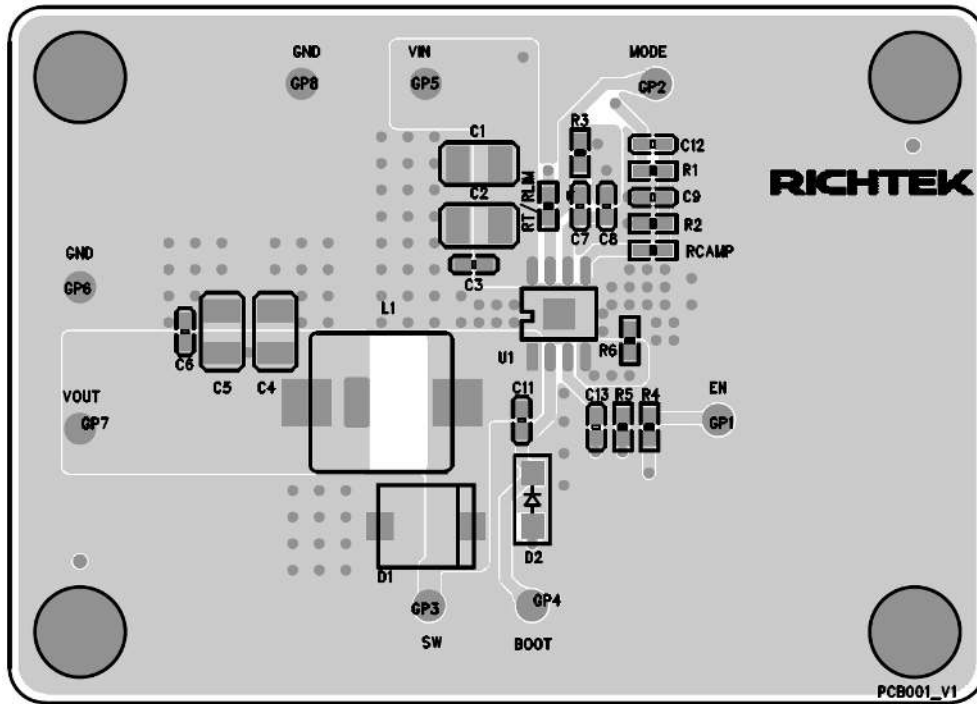

Top View (1st layer)

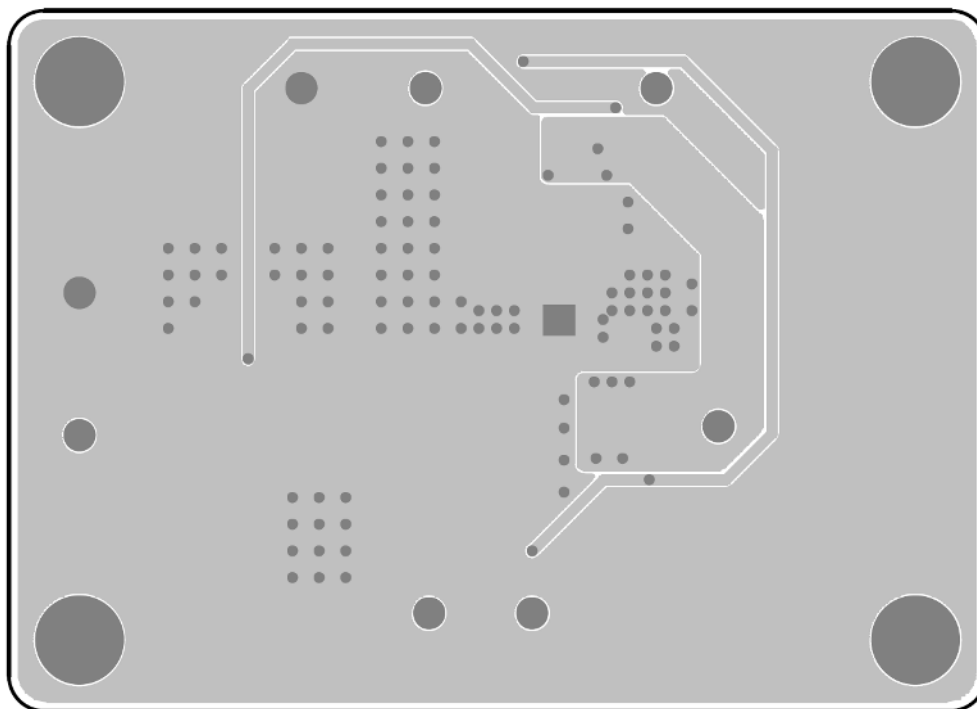

Bottom View (4th Layer)

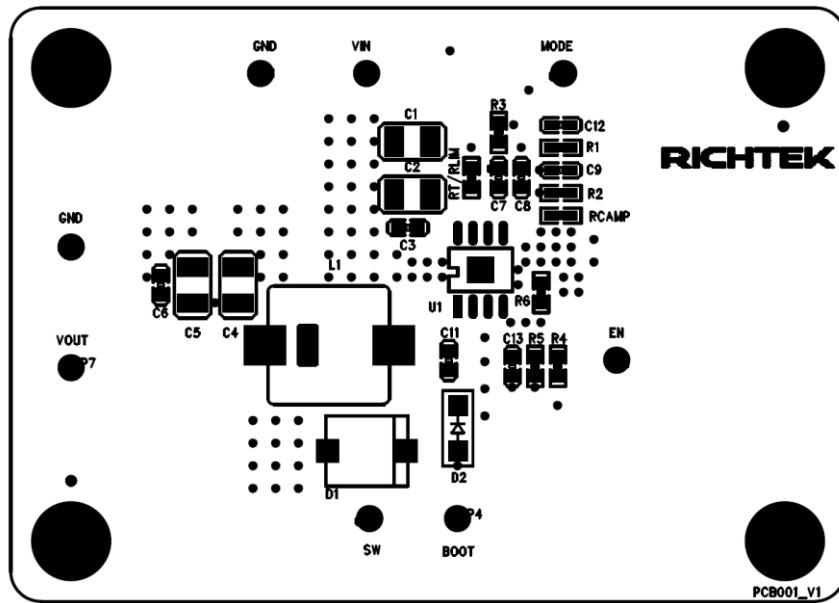

Component Placement Guide—Component Side (1st layer)

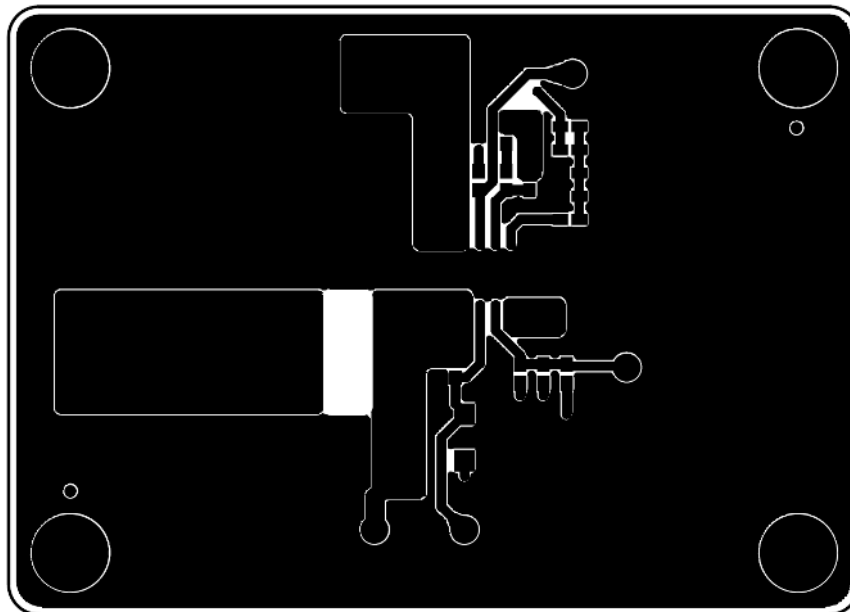

PCB Layout—Component Side (1st Layer)

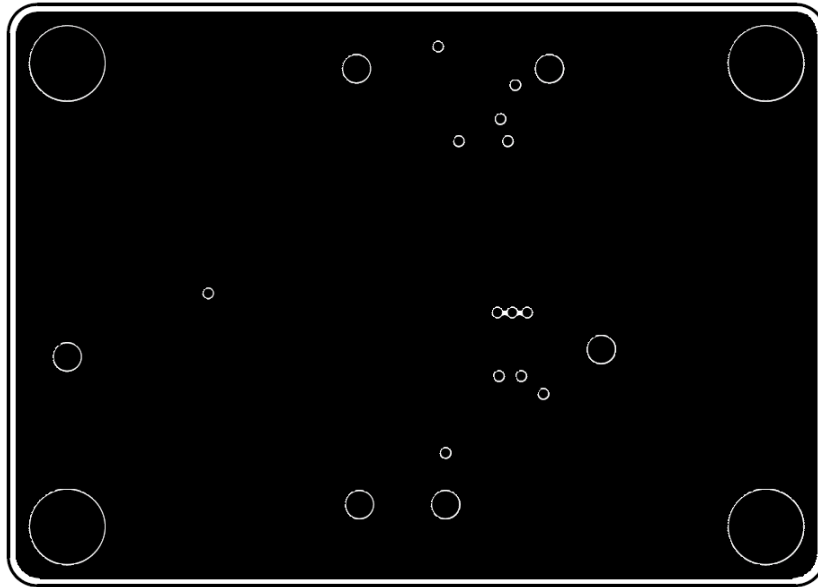

PCB Layout—Inner Side (2nd Layer)

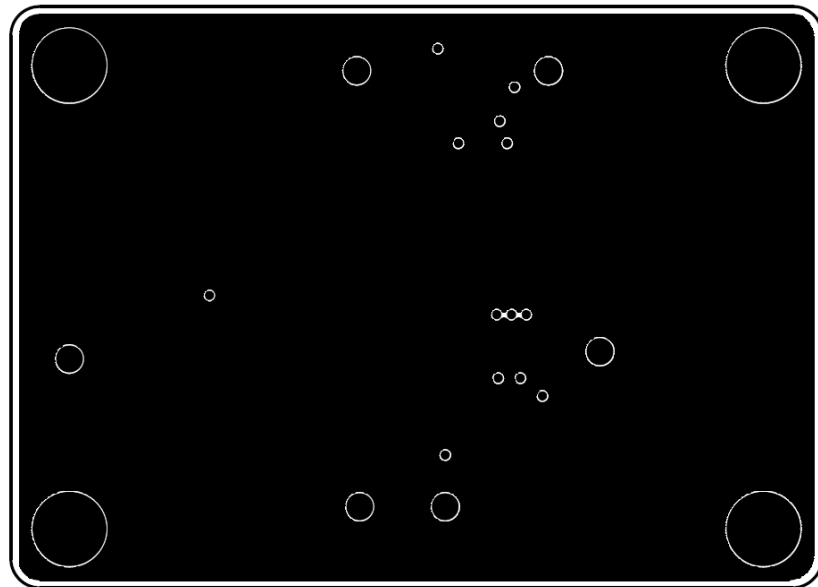

PCB Layout—Inner Side (3rd Layer)

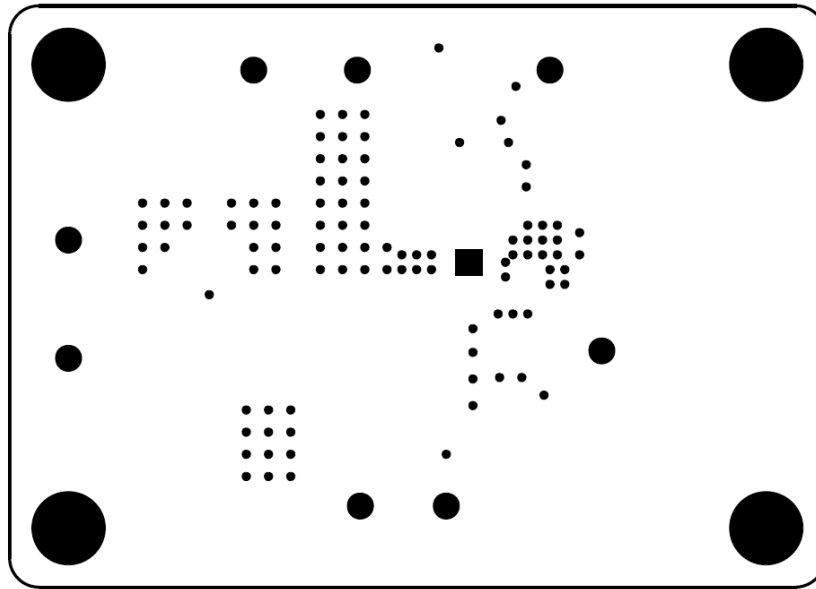

Component Placement Guide—Bottom Side (4th Layer)

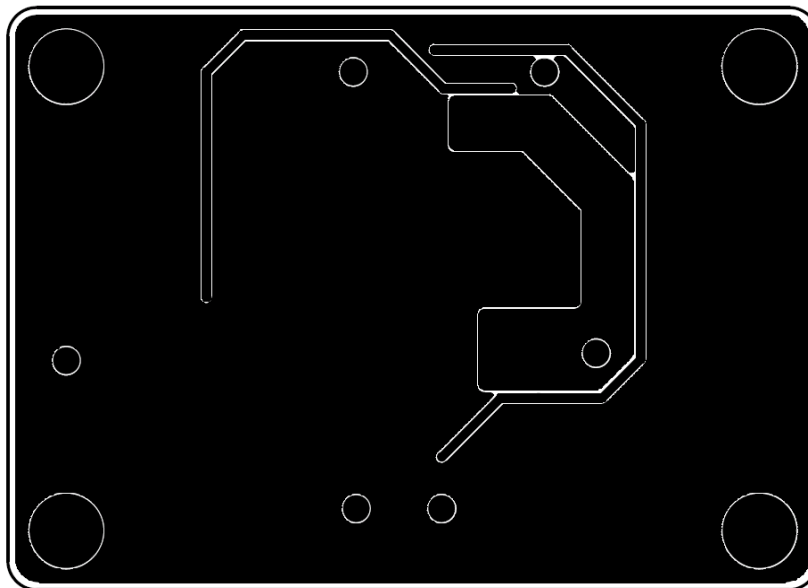

PCB Layout—Bottom Side (4th layer)

More Information

For more information, please find the related datasheet or application notes from Richtek website <http://www.richtek.com>.

Important Notice for Richtek Evaluation Board

THIS DOCUMENT IS FOR REFERENCE ONLY, NOTHING CONTAINED IN THIS DOCUMENT SHALL BE CONSTRUED AS RICHTEK'S WARRANTY, EXPRESS OR IMPLIED, UNDER CONTRACT, TORT OR STATUTORY, WITH RESPECT TO THE PRESENTATION HEREIN. IN NO EVENT SHALL RICHTEK BE LIABLE TO BUYER OR USER FOR ANY AND ALL DAMAGES INCLUDING WITHOUT LIMITATION TO DIRECT, INDIRECT, SPECIAL, PUNITIVE OR CONSEQUENTIAL DAMAGES.