

DO NOT
SCALE FROM
THIS PRINT

TABLE 1					
ITEM	COMPONENT	-HF	-HN	-GF	-GN
1	SUB ASSEMBLY	SUB-HDBNC-J-P-HF-ST-EM1	SUB-HDBNC-J-P-HN-ST-EM1	SUB-HDBNC-J-P-GF-ST-EM1	SUB-HDBNC-J-P-GN-ST-EM1
2	NUT	HDBNC-NUT-001-N			

GENDER
-J: JACK

TYPE
-P: PCB

TERMINATION
-EM1: EDGE MOUNT .062 BOARD

ORIENTATION
-ST: STRAIGHT

PLATING SPECIFICATION
 -HF: 30μ" GOLD CENTER CONTACT,
 3μ" GOLD OUTER CONTACT
 -HN: 30μ" GOLD CENTER CONTACT,
 100μ" NICKEL OUTER CONTACT
 -GF: 10μ" GOLD CENTER CONTACT,
 3μ" GOLD OUTER CONTACT
 -GN: 10μ" GOLD CENTER CONTACT,
 100μ" NICKEL OUTER CONTACT
 (SEE TABLE 1)

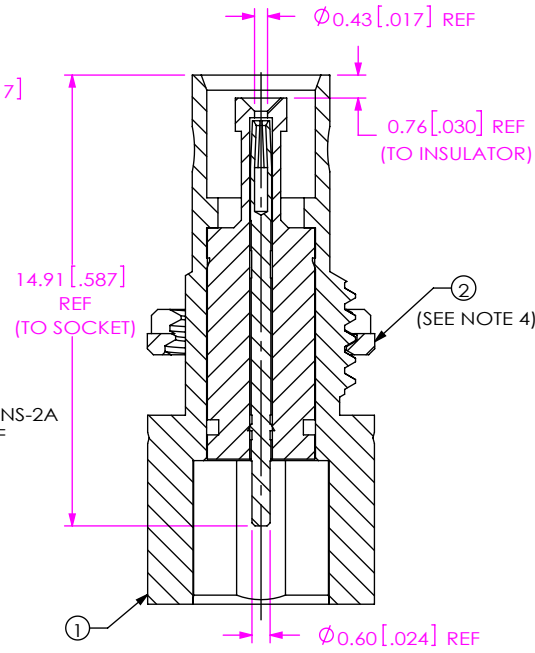
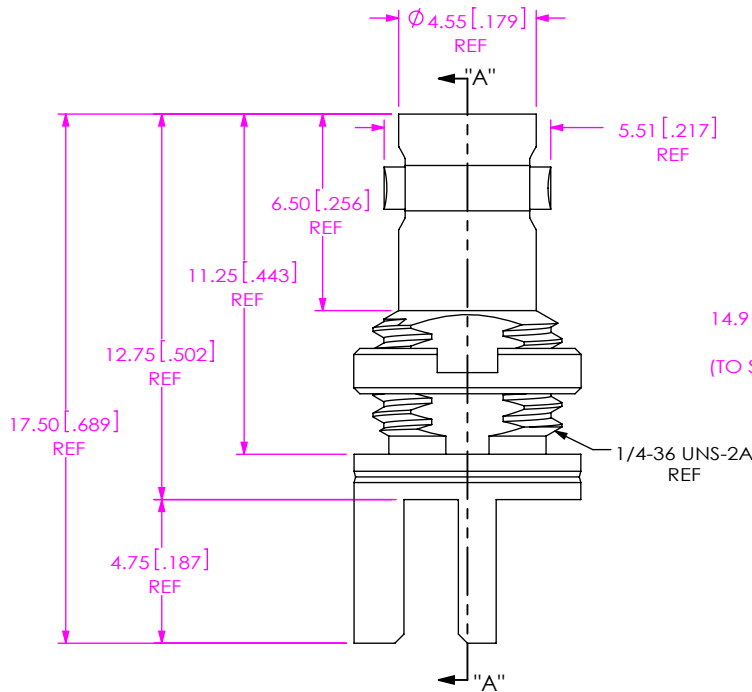
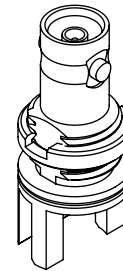
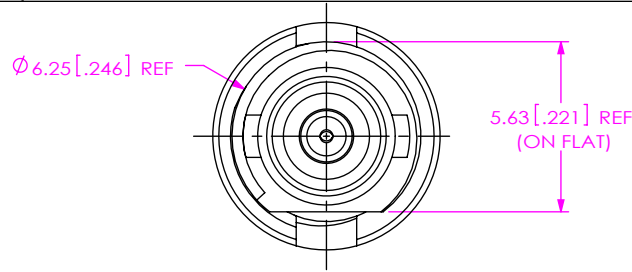

SECTION "A"-A"

RECOMMENDED MOUNTING HOLE
2.70 [079] MAX PANEL THICKNESS

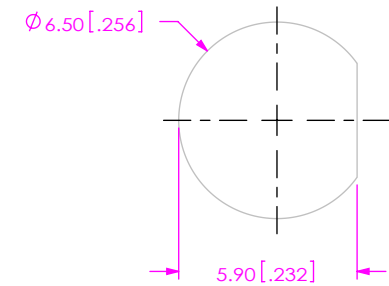

RECOMMENDED PCB LAYOUT
(SEE NOTE 5 & 6)

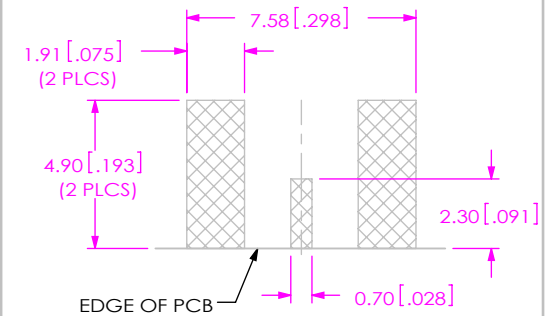

NOTES:

1. REPRESENTS A CRITICAL DIMENSION.
2. NOTE DELETED.
3. PRODUCT TO BE PACKAGED PER PACKING STANDARD CO-RF-WI-3040-M.
TRAY: TY-SMA-001-1
COVER: TY-SMA-001-2
4. NUT TO BE PACKAGED SEPARATELY.
5. STENCIL APERTURES TO BE 1:1 WITH THE PCB SURFACE MOUNT PADS.
STENCIL THICKNESS TO BE 0.13 [005].
6. A FIXTURE IS RECOMMENDED DURING THE REFLOW PROCESS TO HOLD THE CONNECTOR STRAIGHT AND PARALLEL WITH THE PCB.
CONTACT IPG FOR MORE DETAILS.

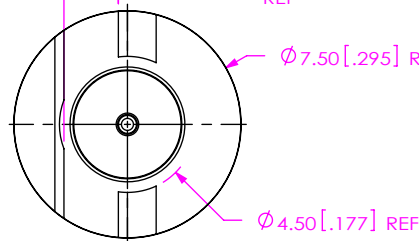

UNLESS OTHERWISE SPECIFIED,
DIMENSIONS ARE IN MILLIMETERS.
TOLERANCES ARE:
DECIMALS ANGLES
X.X: ±0.3 [01] 5°
X.XX: ±0.13 [005]
X.XXX: ±0.051 [0020]

PROPRIETARY NOTE

THIS DOCUMENT CONTAINS CONFIDENTIAL AND PROPRIETARY INFORMATION AND ALL DESIGN, MANUFACTURING, REPRODUCTION, USE, PATENT RIGHTS AND SALES RIGHTS ARE EXPRESSLY RESERVED BY SAMTEC, INC. THIS DOCUMENT SHALL NOT BE DISCLOSED, IN WHOLE OR PART, TO ANY UNAUTHORIZED PERSON OR ENTITY NOR REPRODUCED, TRANSFERRED OR INCORPORATED IN ANY OTHER PROJECT IN ANY MANNER WITHOUT THE EXPRESS WRITTEN CONSENT OF SAMTEC, INC.

MATERIAL: DO NOT SCALE DRAWING SHEET SCALE: 4:1

SOCKET: BeCu
SHELL, NUT: BRASS
INSULATOR: PTFE



520 PARK EAST BLVD, NEW ALBANY, IN 47150
PHONE: 812-944-6733 FAX: 812-948-5047
e-Mail: info@SAMTEC.com code 55322

DESCRIPTION:
HD BNC 75 OHM, ST JACK EDGE MOUNT
DWG. NO.

HDBNC-J-P-XX-ST-EM1

BY: ALVIN W 02/11/2011 SHEET 1 OF 1